

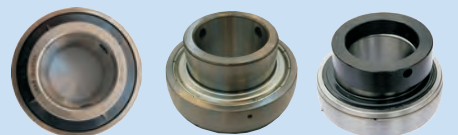

BEARING UNITS INTERCHANGEABLE GUIDE





Bearing Units Interchangeable Guide

Quality Management



日本高導オートメーションテクノロジー株式会社
会社法人等番号 1309-01-001332



16 in NIKO + HYC

Contents

5

INTRODUCTION

11

BY PART NUMBER

61

FIGURE NUMBER

69

DIMENSIONS

129

INTERCHANGEABLE GUIDE

INTRODUCTION



Before you is a practical book about Bearing Units and spherical outside ball bearings named « NIKO + HYC BEARING UNITS INTERCHANGEABLE GUIDE ». It is a practical guide book according to the marketing experience of some businessman in NIKO + HYC Bearing Units, Inc. Some well-known interchangeable guide are included for reference. With the book in hand, the users and marketing businessmen can easily deal with some practical problems and find it convenient to find out the relations between different brands of Bearing Units and have more choices as well.

The book provides 12751 types of Bearing Units from 15 well-known brands and 2422 types of Bearing Units from NIKO + HYC Interchangeability between all 15173 types of mounted units of NIKO + HYC and other 16 brands are listed under different Group Number together with some Graphic and some key technical dimensions.



16 in NIKO + HYC

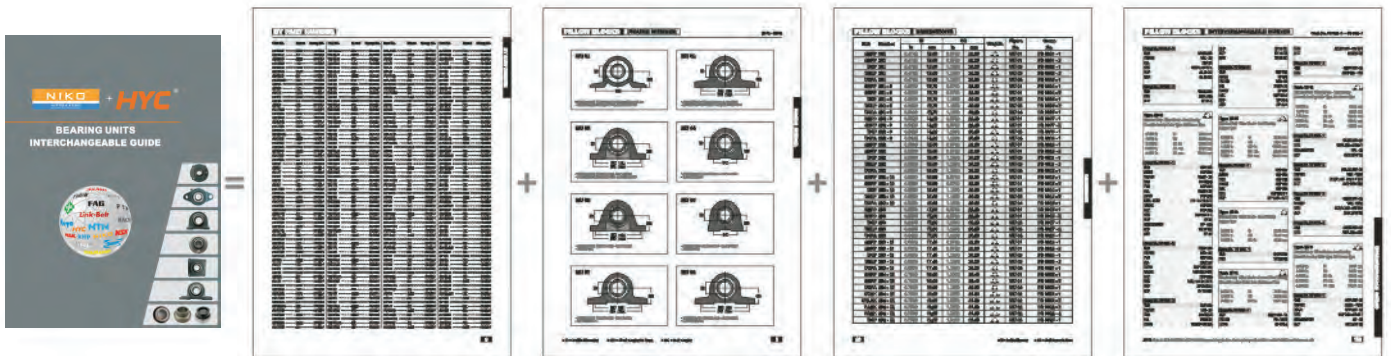

There are four parts in the book.

- 1. BY PART NUMBER:** In this part, we list 15173 types of Bearing Units and spherical outside ball bearings from NIKO + HYC and other 16 brands by part number of 0 to 9, A to Z. Group Number will also be given out.
- 2. FIGURE NUMBER:** In this part, 35 figures from 4 series of Bearing Units and spherical outside ball bearings are listed together with the name of products, graphic and the meaning of the key dimensions.
- 3. DIMENSIONS:** Number of all 2422 types of NIKO + HYC products are given out together with key dimensions, graphic figure number and group number.
- 4. INTERCHANGEABLE GUIDE:** Interchangeable guide is the characteristic part of this book. In this part, the author lists the interchangeable relations of 12751 type from 15 brand and 2422 types from NIKO + HYC

You can easily look up the corresponding type to a certain Bearing Units in this book.

— . Look up a suitable type from **NIKO** + **HYC** to a certain size of Bearing Units.



1. See the **Group NO.** in **BY PART NUMBER** in **ASAHI UCP 205**.

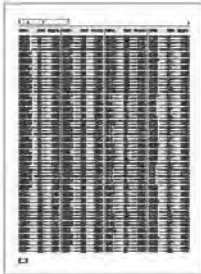

Part No.	Brand	Group No.
.....
UCP 205	ASAHI	PB 0052-1
.....

2. Look for the detail content in **INTERCHANGEABLE GUIDES** according to **Group No. PB 0052-1**.



← Group Nos. PB 0046 - 3 — PB 0052 - 1



Group No. PB 0052 - 1	
SLB	UCP 205
ASAHI	UCP 205
FAFNIR	RASC - 25
FAG	SG 56205
FYH	UCP 205
INA	RASEY 25

Figure MU 03

*Standard Duty Pillow Blocks - Cast Housing
Eccentric Locking Collar Type, Set Screws Type*

0.9843 in	ID	25.00 mm
1.4370 in	SB	36.50 mm
4.1339 in	BC fix	105.00 mm
3.7795 in	BC min	96.00 mm
4.4882 in	BC max	114.00 mm

3. Look up the size and the technology parameter of **NIKO** + **HYC** UCP 205 in « **NIKO** + **HYC** CATALOGUE FOR BEARING UNITS »

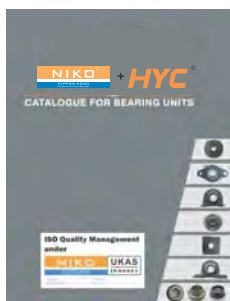

Bearing Units Interchangeable Guide

二、Look up a suitable type from **NIKO** + **HYC** to a certain size of Bearing Units.



1. Find the correct **Figure No** from part of **FIGURE NUMBER**

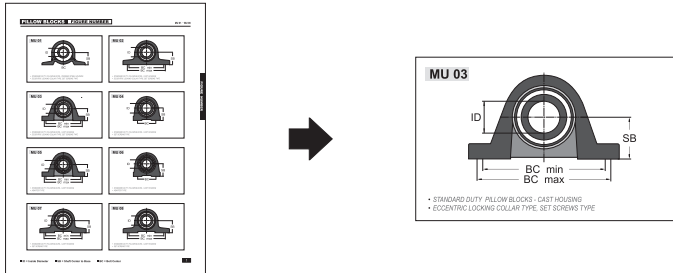

2. **Group No** of **NIKO** + **HYC** products of a certain key dimension and **Figure No** will be easily seen in part of **DIMENSION**

NIKO + HYC Number	ID		SB		Graphic	Figure No.	Group No.
	in	mm	in	mm			
.....
UCP 205	0.9843	25.00	1.4370	36.50		MU 03	PB 0052 - 1

3. With the **Group No.**, repeat 2 to 3 part “ — ”

BY PART NUMBER

Part No.	Brand	Group No.	Part No.	Brand	Group No.	Part No.	Brand	Group No.	Part No.	Brand	Group No.
40MVA+1217-17ECG	SNR	PB 0016-1	ASPP202	NTN	PB 0010-2	BPP 4-12	NACHI	PB 0022-2	GARAP 012 A	KOYO	PB 0025-3
47MVA+1220-20ECG	SNR	PB 0026-1	ASPP202-009	NTN	PB 0007-2	BPP 5	ASAHI	PB 0050-2	GARAP 012 MA	KOYO	PB 0029-3
47MVA+1220-20G	SNR	PB 0026-2	ASPP202-010	NTN	PB 0013-2	BPP 5	NACHI	PB 0050-2	GARAP 013 A	KOYO	PB 0034-3
52MVA+1225-25ECG	SNR	PB 0050-1	ASPP203	NTN	PB 0016-2	BPP 5-14	ASAHI	PB 0038-2	GARAP 014 A	KOYO	PB 0040-3
52MVA+1225-25G	SNR	PB 0050-2	ASPP203-011	NTN	PB 0019-2	BPP 5-14	NACHI	PB 0038-2	GARAP 015 A	KOYO	PB 0046-3
62MVA+1230-30ECG	SNR	PB 0076-1	ASPP204	NTN	PB 0026-2	BPP 5-15	ASAHI	PB 0044-2	GARAP 100 A	KOYO	PB 0060-3
62MVA+1230-30G	SNR	PB 0076-2	ASPP204-012	NTN	PB 0022-2	BPP 5-15	NACHI	PB 0044-2	GARAP 100 MA	KOYO	PB 0052-3
AELPL204-012W3	NTN	PB 0024-3	ASPP205	NTN	PB 0050-2	BPP 5-16	ASAHI	PB 0058-2	GARAP 102 A	KOYO	PB 0072-3
AELPL204W3	NTN	PB 0028-3	ASPP205-013	NTN	PB 0032-2	BPP 5-16	NACHI	PB 0058-2	GARAP 103 A	KOYO	PB 0086-3
AELPL205-013W3	NTN	PB 0033-3	ASPP205-014	NTN	PB 0038-2	BPP 6	ASAHI	PB 0076-2	GARAP 103 A-1	KOYO	PB 0093-3
AELPL205-014W3	NTN	PB 0039-3	ASPP205-015	NTN	PB 0044-2	BPP 6	NACHI	PB 0076-2	GARAP 103 MA	KOYO	PB 0078-3
AELPL205-015W3	NTN	PB 0045-3	ASPP205-100	NTN	PB 0058-2	BPP 6-18	ASAHI	PB 0070-2	GARAP 104 A	KOYO	PB 0096-3
AELPL205-100W3	NTN	PB 0059-3	ASPP206	NTN	PB 0076-2	BPP 6-18	NACHI	PB 0070-2	GARAP 105 A	KOYO	PB 0104-3
AELPL205W3	NTN	PB 0051-3	ASPP206-101	NTN	PB 0064-2	BPP 6-19	ASAHI	PB 0084-2	GARAP 106 A	KOYO	PB 0110-3
AELPL206-101W3	NTN	PB 0065-3	ASPP206-102	NTN	PB 0070-2	BPP 6-19	NACHI	PB 0084-2	GARAP 106 MA	KOYO	PB 0116-3
AELPL206-102W3	NTN	PB 0071-3	ASPP206-103	NTN	PB 0084-2	BPP 7	ASAHI	PB 0114-2	GARAP 107 A	KOYO	PB 0124-3
AELPL206-103W3	NTN	PB 0085-3	ASPP206-104	NTN	PB 0090-2	BPP 7	NACHI	PB 0114-2	GARAP 108 A	KOYO	PB 0129-3
AELPL206-104W3	NTN	PB 0092-3	ASPP207	NTN	PB 0114-2	BPP 7-20	ASAHI	PB 0091-2	GARAP 109 A	KOYO	PB 0134-3
AELPL206W3	NTN	PB 0077-3	ASPP207-104	NTN	PB 0091-2	BPP 7-20	NACHI	PB 0091-2	GARAP 109 MA	KOYO	PB 0139-3
AELPL207-104W3	NTN	PB 0095-3	ASPP207-105	NTN	PB 0102-2	BPP 7-21	ASAHI	PB 0102-2	GARAP 110 A	KOYO	PB 0146-3
AELPL207-105W3	NTN	PB 0103-3	ASPP207-106	NTN	PB 0108-2	BPP 7-21	NACHI	PB 0102-2	GARAP 111 A	KOYO	PB 0151-3
AELPL207-106W3	NTN	PB 0109-3	ASPP207-107	NTN	PB 0122-2	BPP 7-22	ASAHI	PB 0108-2	GARAP 112 A	KOYO	PB 0156-3
AELPL207-107W3	NTN	PB 0123-3	BP 204	ASAHI	PB 0029-4	BPP 7-22	NACHI	PB 0108-2	GARAP 112 MA	KOYO	PB 0161-3
AELPL207W3	NTN	PB 0115-3	BP 204	NACHI	PB 0029-4	BPP 7-23	ASAHI	PB 0122-2	GARAP 114 A	KOYO	PB 0173-3
AELPP201-008W3	NTN	PB 0004-1	BP 204-12	ASAHI	PB 0025-4	BPP 7-23	NACHI	PB 0122-2	GARAP 115 A	KOYO	PB 0178-3
AELPP201W3	NTN	PB 0001-1	BP 204-12	NACHI	PB 0025-4	ENPP 201	NSK	PB 0001-1	GARAP 115 MA	KOYO	PB 0183-3
AELPP202-009W3	NTN	PB 0007-1	BP 205	ASAHI	PB 0052-4	ENPP 202	NSK	PB 0010-1	GARAP 200 A	KOYO	PB 0193-3
AELPP202-010W3	NTN	PB 0013-1	BP 205	NACHI	PB 0052-4	ENPP 203	NSK	PB 0016-1	GARAP 203 A	KOYO	PB 0217-3
AELPP202W3	NTN	PB 0010-1	BP 205-14	ASAHI	PB 0040-4	ENPP 204	NSK	PB 0026-1	GARAP 203 MA	KOYO	PB 0210-3
AELPP203-011W3	NTN	PB 0019-1	BP 205-14	NACHI	PB 0040-4	ENPP 205	NSK	PB 0050-1	LPB1 1/4A	RHP	PB 0090-2
AELPP203W3	NTN	PB 0016-1	BP 205-15	ASAHI	PB 0046-4	ENPP 206	NSK	PB 0076-1	LPB1 1/4AL	RHP	PB 0091-2
AELPP204-012W3	NTN	PB 0022-1	BP 205-15	NACHI	PB 0046-4	ENPP 207	NSK	PB 0114-1	LPB1 1/4EC	RHP	PB 0090-1
AELPP204W3	NTN	PB 0026-1	BP 205-16	ASAHI	PB 0060-4	EWP 204	NSK	PB 0029-2	LPB1 1/4ECL	RHP	PB 0091-1
AELPP205-013W3	NTN	PB 0032-1	BP 205-16	NACHI	PB 0060-4	EWP 205	NSK	PB 0052-2	LPB1 1/8EC	RHP	PB 0070-1
AELPP205-014W3	NTN	PB 0038-1	BP 206	ASAHI	PB 0078-4	EWP 206	NSK	PB 0078-2	LPB1 3/16EC	RHP	PB 0084-1
AELPP205-015W3	NTN	PB 0044-1	BP 206	NACHI	PB 0078-4	EWP 207	NSK	PB 0116-2	LPB1 3/8EC	RHP	PB 0108-1
AELPP205-100W3	NTN	PB 0058-1	BP 206-18	ASAHI	PB 0072-4	EWP 208	NSK	PB 0139-2	LPB1 7/16EC	RHP	PB 0122-1
AELPP205W3	NTN	PB 0050-1	BP 206-18	NACHI	PB 0072-4	EWP 209	NSK	PB 0161-2	LPB1/2EC	RHP	PB 0004-1
AELPP206-101W3	NTN	PB 0064-1	BP 206-19	ASAHI	PB 0086-4	EWP 210	NSK	PB 0183-2	LPB1/2EC	RHP	PB 0001-1
AELPP206-102W3	NTN	PB 0070-1	BP 206-19	NACHI	PB 0086-4	EWP 211	NSK	PB 0210-2	LPB15/16EC	RHP	PB 0044-1
AELPP206-103W3	NTN	PB 0084-1	BP 207	ASAHI	PB 0116-4	EWP 212	NSK	PB 0232-2	LPB15EC	RHP	PB 0010-1
AELPP206-104W3	NTN	PB 0090-1	BP 207	NACHI	PB 0116-4	GAP 1012 B	KOYO	PB 0025-2	LPB17EC	RHP	PB 0016-1
AELPP206W3	NTN	PB 0076-1	BP 207-20	ASAHI	PB 0096-4	GAP 1012 MB	KOYO	PB 0029-2	LPB1A	RHP	PB 0058-2
AELPP207-104W3	NTN	PB 0091-1	BP 207-20	NACHI	PB 0096-4	GAP 1013 B	KOYO	PB 0034-2	LPB1EC	RHP	PB 0058-1
AELPP207-105W3	NTN	PB 0102-1	BP 207-21	ASAHI	PB 0104-4	GAP 1014 B	KOYO	PB 0040-2	LPB20A	RHP	PB 0026-2
AELPP207-106W3	NTN	PB 0108-1	BP 207-21	NACHI	PB 0104-4	GAP 1015 B	KOYO	PB 0046-2	LPB20EC	RHP	PB 0026-1
AELPP207-107W3	NTN	PB 0122-1	BP 207-22	ASAHI	PB 0110-4	GAP 1100 B	KOYO	PB 0060-2	LPB25A	RHP	PB 0050-2
AELPP207W3	NTN	PB 0114-1	BP 207-22	NACHI	PB 0110-4	GAP 1100 MB	KOYO	PB 0052-2	LPB25EC	RHP	PB 0050-1
ASPL204	NTN	PB 0028-4	BP 207-23	ASAHI	PB 0124-4	GAP 1102 B	KOYO	PB 0072-2	LPB3/4A	RHP	PB 0022-2
ASPL204-012	NTN	PB 0024-4	BP 207-23	NACHI	PB 0124-4	GAP 1103 B	KOYO	PB 0086-2	LPB3/4EC	RHP	PB 0022-1
ASPL205	NTN	PB 0051-4	BPP 1	ASAHI	PB 0001-2	GAP 1103 B-1	KOYO	PB 0093-2	LPB30A	RHP	PB 0076-2
ASPL205-013	NTN	PB 0033-4	BPP 1	NACHI	PB 0001-2	GAP 1103 MB	KOYO	PB 0078-2	LPB30EC	RHP	PB 0076-1
ASPL205-014	NTN	PB 0039-4	BPP 1-8	ASAHI	PB 0004-2	GAP 1104 B	KOYO	PB 0096-2	LPB35A	RHP	PB 0114-2
ASPL205-015	NTN	PB 0045-4	BPP 1-8	NACHI	PB 0004-2	GAP 1105 B	KOYO	PB 0104-2	LPB35EC	RHP	PB 0114-1
ASPL205-100	NTN	PB 0059-4	BPP 2	ASAHI	PB 0010-2	GAP 1106 B	KOYO	PB 0110-2	LPB5/8EC	RHP	PB 0013-1
ASPL206	NTN	PB 0077-4	BPP 2	NACHI	PB 0010-2	GAP 1106 MB	KOYO	PB 0116-2	LPB7/8EC	RHP	PB 0038-1
ASPL206-101	NTN	PB 0065-4	BPP 2-10	ASAHI	PB 0013-2	GAP 1107 B	KOYO	PB 0124-2	MP1	RHP	PB 0062-1
ASPL206-102	NTN	PB 0071-4	BPP 2-10	NACHI	PB 0013-2	GAP 1108 B	KOYO	PB 0129-2	MP1 1/2	RHP	PB 0131-1
ASPL206-103	NTN	PB 0085-4	BPP 2-9	ASAHI	PB 0007-2	GAP 1109 B	KOYO	PB 0134-2	MP1 1/4	RHP	PB 0098-1
ASPL206-104	NTN	PB 0092-4	BPP 2-9	NACHI	PB 0007-2	GAP 1109 MB	KOYO	PB 0139-2	MP1 11/16	RHP	PB 0153-1
ASPL207	NTN	PB 0115-4	BPP 3	ASAHI	PB 0016-2	GAP 1110 B	KOYO	PB 0146-2	MP1 15/16	RHP	PB 0180-1
ASPL207-104	NTN	PB 0095-4	BPP 3	NACHI	PB 0016-2	GAP 1111 B	KOYO	PB 0151-2	MP1 3/16	RHP	PB 0088-1
ASPL207-105	NTN	PB 0103-4	BPP 3-11	ASAHI	PB 0019-2	GAP 1112 B	KOYO	PB 0156-2	MP1 3/4	RHP	PB 0158-1
ASPL207-106	NTN	PB 0109-4	BPP 3-11	NACHI	PB 0019-2	GAP 1112 MB	KOYO	PB 0161-2	MP1 3/8	RHP	PB 0112-1
ASPL207-107	NTN	PB 0123-4	BPP 4	ASAHI	PB 0026-2	GAP 1114 B	KOYO	PB 0173-2	MP1 7/16	RHP	PB 0126-1
ASPP201	NTN	PB 0001-2	BPP 4	NACHI	PB 0026-2	GAP 1115 B	KOYO	PB 0178-2	MP1 7/8	RHP	PB 0175-1
ASPP201-008	NTN	PB 0004-2	BPP 4-12	ASAHI	PB 0022-2	GAP 1115 MB	KOYO	PB 0183-2	MP-15	SEALMASTER	PB 0048-1

BY PART NUMBER

Part No.	Brand	Group No.	Part No.	Brand	Group No.	Part No.	Brand	Group No.	Part No.	Brand	Group No.
MP-16	SEALMASTER	PB 0062-1	NAP 208	FYH	PB 0139-2	NP-11	SEALMASTER	PB 0020-1	NP2R	RHP	PB 0190-1
MP-19	SEALMASTER	PB 0088-1	NAP 208-24	FYH	PB 0129-2	NP-12	SEALMASTER	PB 0025-1	NP3	RHP	PB 0296-1
MP2 1/2	RHP	PB 0251-1	NAP 209	FYH	PB 0161-2	NP-13	SEALMASTER	PB 0034-1	NP3 1/2	RHP	PB 0313-1
MP2 1/4	RHP	PB 0224-1	NAP 209-26	FYH	PB 0146-2	NP-14	SEALMASTER	PB 0040-1	NP3 1/4	RHP	PB 0309-1
MP2 11/16	RHP	PB 0269-1	NAP 209-27	FYH	PB 0151-2	NP-15	SEALMASTER	PB 0046-1	NP3 7/16	RHP	PB 0312-1
MP2 15/16	RHP	PB 0289-1	NAP 209-28	FYH	PB 0156-2	NP15/16	RHP	PB 0046-1	NP3/4	RHP	PB 0025-1
MP2 3/16	RHP	PB 0219-1	NAP 210	FYH	PB 0183-2	NP15/16DEC	RHP	PB 0046-2	NP3/4A	RHP	PB 0025-4
MP2 3/4	RHP	PB 0273-1	NAP 210-31	FYH	PB 0178-2	NP15/16EC	RHP	PB 0046-3	NP3/4DEC	RHP	PB 0025-2
MP2 7/16	RHP	PB 0246-1	NAP 211	FYH	PB 0210-2	NP-16	SEALMASTER	PB 0060-1	NP3/4EC	RHP	PB 0025-3
MP-20	SEALMASTER	PB 0098-1	NAP 211-32	FYH	PB 0193-2	NP-17	SEALMASTER	PB 0066-1	NP30	RHP	PB 0078-1
MP-23	SEALMASTER	PB 0126-1	NAP 211-35	FYH	PB 0217-2	NP-18	SEALMASTER	PB 0072-1	NP30	SNR	PB 0078-1
MP-24	SEALMASTER	PB 0131-1	NAP 212	FYH	PB 0232-2	NP-19	SEALMASTER	PB 0086-1	NP-30	SEALMASTER	PB 0173-1
MP25	RHP	PB 0056-1	NAP 212-36	FYH	PB 0222-2	NP1A	RHP	PB 0060-4	NP30A	RHP	PB 0078-4
MP-27	SEALMASTER	PB 0153-1	NAP 212-39	FYH	PB 0244-2	NP1EC	RHP	PB 0060-3	NP30A	SNR	PB 0078-4
MP-28	SEALMASTER	PB 0158-1	NAP 213	FYH	PB 0254-2	NP1EDEC	RHP	PB 0060-2	NP30DEC	RHP	PB 0078-2
MP2R	RHP	PB 0195-1	NAP 213-40	FYH	PB 0249-2	NP2	RHP	PB 0193-1	NP30EC	RHP	PB 0078-3
MP3	RHP	PB 0297-1	NAP 215	FYH	PB 0292-2	NP2 1/2	RHP	PB 0249-1	NP30EC	SNR	PB 0078-3
MP30	RHP	PB 0082-1	NAP 215-47	FYH	PB 0288-2	NP2 1/2DEC	RHP	PB 0249-2	NP-31	SEALMASTER	PB 0178-1
MP-305	SEALMASTER	PB 0056-1	NAP 215-48	FYH	PB 0296-2	NP2 1/4	RHP	PB 0222-1	NP-32	SEALMASTER	PB 0193-1
MP-306	SEALMASTER	PB 0082-1	NP1	RHP	PB 0060-1	NP2 1/4DEC	RHP	PB 0222-2	NP-32R	SEALMASTER	PB 0190-1
MP-307	SEALMASTER	PB 0120-1	NP1 1/2	RHP	PB 0129-1	NP2 1/8	RHP	PB 0205-1	NP-34	SEALMASTER	PB 0205-1
MP-308	SEALMASTER	PB 0143-1	NP1 1/2A	RHP	PB 0129-4	NP2 1/8DEC	RHP	PB 0205-2	NP35	RHP	PB 0116-1
MP-309	SEALMASTER	PB 0165-1	NP1 1/2DEC	RHP	PB 0129-2	NP2 11/16	RHP	PB 0268-1	NP35	SNR	PB 0116-1
MP-31	SEALMASTER	PB 0180-1	NP1 1/2EC	RHP	PB 0129-3	NP2 15/16	RHP	PB 0288-1	NP-35	SEALMASTER	PB 0217-1
MP-310	SEALMASTER	PB 0187-1	NP1 1/4	RHP	PB 0096-1	NP2 3/16	RHP	PB 0217-1	NP35A	RHP	PB 0116-4
MP-311	SEALMASTER	PB 0212-1	NP1 1/4A	RHP	PB 0096-4	NP2 3/16DEC	RHP	PB 0217-2	NP35A	SNR	PB 0116-4
MP-313	SEALMASTER	PB 0256-1	NP1 1/4AR	RHP	PB 0093-4	NP2 3/4	RHP	PB 0272-1	NP35DEC	RHP	PB 0116-2
MP-314	SEALMASTER	PB 0277-1	NP1 1/4DEC	RHP	PB 0096-2	NP2 3/8	RHP	PB 0239-1	NP35EC	RHP	PB 0116-3
MP-315	SEALMASTER	PB 0293-1	NP1 1/4DECR	RHP	PB 0093-2	NP2 3/8DEC	RHP	PB 0239-2	NP35EC	SNR	PB 0116-3
MP-316	SEALMASTER	PB 0306-1	NP1 1/4EC	RHP	PB 0096-3	NP2 7/16	RHP	PB 0244-1	NP-36	SEALMASTER	PB 0222-1
MP-32	SEALMASTER	PB 0195-1	NP1 1/4ECR	RHP	PB 0093-3	NP2 7/16DEC	RHP	PB 0244-2	NP-38	SEALMASTER	PB 0239-1
MP35	RHP	PB 0120-1	NP1 1/4R	RHP	PB 0093-1	NP2 7/8	RHP	PB 0284-1	NP-39	SEALMASTER	PB 0244-1
MP-35	SEALMASTER	PB 0219-1	NP1 1/8	RHP	PB 0072-1	NP20	RHP	PB 0029-1	NP40	RHP	PB 0139-1
MP-36	SEALMASTER	PB 0224-1	NP1 1/8DEC	RHP	PB 0072-2	NP20	SNR	PB 0029-1	NP40	SNR	PB 0139-1
MP-39	SEALMASTER	PB 0246-1	NP1 1/8EC	RHP	PB 0072-3	NP-20	SEALMASTER	PB 0096-1	NP40A	RHP	PB 0139-4
MP40	RHP	PB 0143-1	NP1 11/16	RHP	PB 0151-1	NP-204	SEALMASTER	PB 0029-1	NP40A	SNR	PB 0139-4
MP-40	SEALMASTER	PB 0251-1	NP1 11/16DEC	RHP	PB 0151-2	NP-205	SEALMASTER	PB 0052-1	NP40DEC	RHP	PB 0139-2
MP-43	SEALMASTER	PB 0269-1	NP1 11/16EC	RHP	PB 0151-3	NP-206	SEALMASTER	PB 0078-1	NP40EC	RHP	PB 0139-3
MP45	RHP	PB 0165-1	NP1 15/16	RHP	PB 0178-1	NP-207	SEALMASTER	PB 0116-1	NP40EC	SNR	PB 0139-3
MP-47	SEALMASTER	PB 0289-1	NP1 15/16DEC	RHP	PB 0178-2	NP-208	SEALMASTER	PB 0139-1	NP45	RHP	PB 0161-1
MP-48	SEALMASTER	PB 0297-1	NP1 15/16EC	RHP	PB 0178-3	NP-209	SEALMASTER	PB 0161-1	NP45DEC	RHP	PB 0161-2
MP50	RHP	PB 0187-1	NP1 3/16	RHP	PB 0086-1	NP20A	RHP	PB 0029-4	NP45EC	RHP	PB 0161-3
MP55	RHP	PB 0212-1	NP1 3/16DEC	RHP	PB 0086-2	NP20A	SNR	PB 0029-4	NP45EC	SNR	PB 0161-3
MP60	RHP	PB 0236-1	NP1 3/16EC	RHP	PB 0086-3	NP20DEC	RHP	PB 0029-2	NP50	RHP	PB 0183-1
MP65	RHP	PB 0256-1	NP1 3/4	RHP	PB 0156-1	NP20EC	RHP	PB 0029-3	NP50	SNR	PB 0183-1
MP70	RHP	PB 0277-1	NP1 3/4DEC	RHP	PB 0156-2	NP20EC	SNR	PB 0029-3	NP50DEC	RHP	PB 0183-2
MP75	RHP	PB 0293-1	NP1 3/4EC	RHP	PB 0156-3	NP-20R	SEALMASTER	PB 0093-1	NP50EC	RHP	PB 0183-3
MP80	RHP	PB 0306-1	NP1 3/8	RHP	PB 0110-1	NP-21	SEALMASTER	PB 0104-1	NP50EC	SNR	PB 0183-3
NAP 201	FYH	PB 0002-2	NP1 3/8DEC	RHP	PB 0110-2	NP-210	SEALMASTER	PB 0183-1	NP55	RHP	PB 0210-1
NAP 201-8	FYH	PB 0005-2	NP1 3/8EC	RHP	PB 0110-3	NP-211	SEALMASTER	PB 0210-1	NP55	SNR	PB 0210-1
NAP 202	FYH	PB 0011-2	NP1 5/8	RHP	PB 0146-1	NP-212	SEALMASTER	PB 0232-1	NP55DEC	RHP	PB 0210-2
NAP 202-10	FYH	PB 0014-2	NP1 5/8DEC	RHP	PB 0146-2	NP-22	SEALMASTER	PB 0110-1	NP60	RHP	PB 0232-1
NAP 203	FYH	PB 0017-2	NP1 5/8EC	RHP	PB 0146-3	NP-23	SEALMASTER	PB 0124-1	NP60	SNR	PB 0232-1
NAP 204	FYH	PB 0029-2	NP1 7/16	RHP	PB 0124-1	NP-24	SEALMASTER	PB 0129-1	NP60DEC	RHP	PB 0232-2
NAP 204-12	FYH	PB 0025-2	NP1 7/16DEC	RHP	PB 0124-2	NP25	RHP	PB 0052-1	NP65	RHP	PB 0254-1
NAP 205	FYH	PB 0052-2	NP1 7/16EC	RHP	PB 0124-3	NP25	SNR	PB 0052-1	NP65DEC	RHP	PB 0254-2
NAP 205-14	FYH	PB 0040-2	NP1 7/8	RHP	PB 0173-1	NP-25	SEALMASTER	PB 0134-1	NP7/8	RHP	PB 0040-1
NAP 205-15	FYH	PB 0046-2	NP1 7/8DEC	RHP	PB 0173-2	NP25A	RHP	PB 0052-4	NP7/8DEC	RHP	PB 0040-2
NAP 205-16	FYH	PB 0060-2	NP1 7/8EC	RHP	PB 0173-3	NP25A	SNR	PB 0052-4	NP7/8EC	RHP	PB 0040-3
NAP 206	FYH	PB 0078-2	NP-10	SEALMASTER	PB 0014-1	NP25DEC	RHP	PB 0052-2	NP70	RHP	PB 0276-1
NAP 206-18	FYH	PB 0072-2	NP1025-20K	RHP	PB 0030-1	NP25EC	RHP	PB 0052-3	NP70	SNR	PB 0276-1
NAP 206-19	FYH	PB 0086-2	NP1030-25K	RHP	PB 0054-1	NP25EC	SNR	PB 0052-3	NP70DEC	RHP	PB 0276-2
NAP 206-20	FYH	PB 0093-2	NP1035-30K	RHP	PB 0080-1	NP-26	SEALMASTER	PB 0146-1	NP75	RHP	PB 0292-1
NAP 207	FYH	PB 0116-2	NP1040-35K	RHP	PB 0118-1	NP-27	SEALMASTER	PB 0151-1	NP75	SNR	PB 0292-1
NAP 207-20	FYH	PB 0096-2	NP1045-40K	RHP	PB 0141-1	NP-28	SEALMASTER	PB 0156-1	NP75DEC	RHP	PB 0292-2
NAP 207-22	FYH	PB 0110-2	NP1050-45K	RHP	PB 0163-1	NP-29	SEALMASTER	PB 0168-1	NP-8	SEALMASTER	PB 0005-1
NAP 207-23	FYH	PB 0124-2	NP1055-50K	RHP	PB 0185-1	NP2DEC	RHP	PB 0193-2	NP80	RHP	PB 0305-1

BY PART NUMBER

BY PART NUMBER

Part No.	Brand	Group No.	Part No.	Brand	Group No.	Part No.	Brand	Group No.	Part No.	Brand	Group No.
NP80	SNR	PB 0305-1	P3-U228N	LINK-BELT	PB 0156-1	P3-Y2E32N	LINK-BELT	PB 0190-2	PB-1	FAFNIR	PB 0058-1
NP85	RHP	PB 0311-1	P3-U231N	LINK-BELT	PB 0178-1	PAK 1 1/16"	INA	PB 0065-3	PB-1/2	FAFNIR	PB 0004-1
NP-9	SEALMASTER	PB 0008-1	P3-U232N	LINK-BELT	PB 0193-1	PAK 1 1/2"	INA	PB 0128-3	PB-1-1/16	FAFNIR	PB 0064-1
NP90	RHP	PB 0314-1	P3-U235N	LINK-BELT	PB 0217-1	PAK 1 1/4"	INA	PB 0095-3	PB-1-1/4S	FAFNIR	PB 0090-1
NP90	SNR	PB 0314-1	P3-U236N	LINK-BELT	PB 0222-1	PAK 1 1/4"-206	INA	PB 0092-3	PB-1-1/8	FAFNIR	PB 0070-1
NPL-12	SEALMASTER	PB 0024-1	P3-U238N	LINK-BELT	PB 0239-1	PAK 1 1/8"	INA	PB 0071-3	PB-13/16	FAFNIR	PB 0032-1
NPL-13	SEALMASTER	PB 0033-1	P3-U239N	LINK-BELT	PB 0244-1	PAK 1 15/16"	INA	PB 0177-3	PB-1-3/16	FAFNIR	PB 0084-1
NPL-14	SEALMASTER	PB 0039-1	P3-U240N	LINK-BELT	PB 0249-1	PAK 1 3/16"	INA	PB 0085-3	PB-15/16	FAFNIR	PB 0044-1
NPL-15	SEALMASTER	PB 0045-1	P3-U243N	LINK-BELT	PB 0268-1	PAK 1 3/4"	INA	PB 0155-3	PB-17	FAFNIR	PB 0016-1
NPL-16	SEALMASTER	PB 0059-1	P3-U244N	LINK-BELT	PB 0272-1	PAK 1 3/8"	INA	PB 0109-3	PB-20	FAFNIR	PB 0026-1
NPL-17	SEALMASTER	PB 0065-1	P3-U247N	LINK-BELT	PB 0288-1	PAK 1 7/16"	INA	PB 0123-3	PB-25	FAFNIR	PB 0050-1
NPL-18	SEALMASTER	PB 0071-1	P3-U255N	LINK-BELT	PB 0312-1	PAK 1"	INA	PB 0059-3	PB-3/4	FAFNIR	PB 0022-1
NPL-19	SEALMASTER	PB 0085-1	P3-U2B08N	LINK-BELT	PB 0005-1	PAK 2 3/16"	INA	PB 0216-3	PB-30	FAFNIR	PB 0076-1
NPL-20	SEALMASTER	PB 0095-1	P3-U2E20N	LINK-BELT	PB 0093-1	PAK 2"	INA	PB 0192-3	PB-5/8	FAFNIR	PB 0013-1
NPL-204	SEALMASTER	PB 0028-1	P3-U2E48N	LINK-BELT	PB 0296-1	PAK 20	INA	PB 0028-3	PB-7/8	FAFNIR	PB 0038-1
NPL-205	SEALMASTER	PB 0051-1	P3-U2M17N	LINK-BELT	PB 0017-1	PAK 25	INA	PB 0051-3	PB-9/16	FAFNIR	PB 0007-1
NPL-206	SEALMASTER	PB 0077-1	P3-U2M20N	LINK-BELT	PB 0029-1	PAK 3/4"	INA	PB 0024-3	PBP 16 MJ	KOYO	PB 0052-4
NPL-207	SEALMASTER	PB 0115-1	P3-U2M25N	LINK-BELT	PB 0052-1	PAK 30	INA	PB 0077-3	PBP 19 MJ	KOYO	PB 0078-4
NPL-208	SEALMASTER	PB 0138-1	P3-U2M30N	LINK-BELT	PB 0078-1	PAK 35	INA	PB 0115-3	PBP 22 MJ	KOYO	PB 0116-4
NPL-209	SEALMASTER	PB 0160-1	P3-U2M35N	LINK-BELT	PB 0116-1	PAK 40	INA	PB 0138-3	PBP 25 MJ	KOYO	PB 0139-4
NPL-20R	SEALMASTER	PB 0092-1	P3-U2M40N	LINK-BELT	PB 0139-1	PAK 45	INA	PB 0160-3	PBY 1"	INA	PB 0058-2
NPL-21	SEALMASTER	PB 0103-1	P3-U2M45N	LINK-BELT	PB 0161-1	PAK 50	INA	PB 0182-3	PBY 12	INA	PB 0001-2
NPL-210	SEALMASTER	PB 0182-1	P3-U2M50N	LINK-BELT	PB 0183-1	PAK 55	INA	PB 0209-3	PBY 15	INA	PB 0010-2
NPL-211	SEALMASTER	PB 0209-1	P3-U2M55N	LINK-BELT	PB 0210-1	PAK 7/8"	INA	PB 0039-3	PBY 17	INA	PB 0016-2
NPL-212	SEALMASTER	PB 0231-1	P3-U2M60N	LINK-BELT	PB 0232-1	PASE 1 1/16"	INA	PB 0066-3	PBY 20	INA	PB 0026-2
NPL-22	SEALMASTER	PB 0109-1	P3-U2M65N	LINK-BELT	PB 0254-1	PASE 1 1/2"	INA	PB 0129-3	PBY 25	INA	PB 0050-2
NPL-23	SEALMASTER	PB 0123-1	P3-U2M75N	LINK-BELT	PB 0292-1	PASE 1 1/4"	INA	PB 0096-3	PBY 30	INA	PB 0076-2
NPL-24	SEALMASTER	PB 0128-1	P3-U2M85N	LINK-BELT	PB 0311-1	PASE 1 1/4"-206	INA	PB 0093-3	PL3-S212E	LINK-BELT	PB 0024-4
NPL-25	SEALMASTER	PB 0133-1	P3-W212U	LINK-BELT	PB 0025-3	PASE 1 1/8"	INA	PB 0072-3	PL3-S214E	LINK-BELT	PB 0039-4
NPL-26	SEALMASTER	PB 0145-1	P3-W214U	LINK-BELT	PB 0040-3	PASE 1 15/16"	INA	PB 0178-3	PL3-S215E	LINK-BELT	PB 0045-4
NPL-27	SEALMASTER	PB 0150-1	P3-W215U	LINK-BELT	PB 0046-3	PASE 1 3/16"	INA	PB 0086-3	PL3-S216E	LINK-BELT	PB 0059-4
NPL-28	SEALMASTER	PB 0155-1	P3-W216U	LINK-BELT	PB 0060-3	PASE 1 3/4"	INA	PB 0156-3	PL3-S218E	LINK-BELT	PB 0071-4
NPL-29	SEALMASTER	PB 0167-1	P3-W218E	LINK-BELT	PB 0072-3	PASE 1 3/8"	INA	PB 0110-3	PL3-S219E	LINK-BELT	PB 0085-4
NPL-30	SEALMASTER	PB 0172-1	P3-W219E	LINK-BELT	PB 0086-3	PASE 1 7/16"	INA	PB 0124-3	PL3-S220E	LINK-BELT	PB 0095-4
NPL-31	SEALMASTER	PB 0177-1	P3-W220E	LINK-BELT	PB 0096-3	PASE 1"	INA	PB 0060-3	PL3-S222E	LINK-BELT	PB 0109-4
NPL-32	SEALMASTER	PB 0192-1	P3-W222E	LINK-BELT	PB 0110-3	PASE 2 3/16"	INA	PB 0217-3	PL3-S223E	LINK-BELT	PB 0123-4
NPL-32R	SEALMASTER	PB 0189-1	P3-W223E	LINK-BELT	PB 0124-3	PASE 2"	INA	PB 0193-3	PL3-S224E	LINK-BELT	PB 0128-4
NPL-34	SEALMASTER	PB 0204-1	P3-W224E	LINK-BELT	PB 0129-3	PASE 20	INA	PB 0029-3	PL3-S2E20E	LINK-BELT	PB 0092-4
NPL-35	SEALMASTER	PB 0216-1	P3-W226U	LINK-BELT	PB 0146-3	PASE 25	INA	PB 0052-3	PL3-U212N	LINK-BELT	PB 0024-1
NPL-36	SEALMASTER	PB 0221-1	P3-W227U	LINK-BELT	PB 0151-3	PASE 3/4"	INA	PB 0025-3	PL3-U214N	LINK-BELT	PB 0039-1
NPL-38	SEALMASTER	PB 0238-1	P3-W228U	LINK-BELT	PB 0156-3	PASE 30	INA	PB 0078-3	PL3-U215N	LINK-BELT	PB 0045-1
NPL-39	SEALMASTER	PB 0243-1	P3-W231U	LINK-BELT	PB 0178-3	PASE 35	INA	PB 0116-3	PL3-U216N	LINK-BELT	PB 0059-1
P3-S212E	LINK-BELT	PB 0025-4	P3-W2E20E	LINK-BELT	PB 0093-3	PASE 40	INA	PB 0139-3	PL3-U218N	LINK-BELT	PB 0071-1
P3-S214E	LINK-BELT	PB 0040-4	P3-W2E32U	LINK-BELT	PB 0190-3	PASE 45	INA	PB 0161-3	PL3-U219N	LINK-BELT	PB 0085-1
P3-S215E	LINK-BELT	PB 0046-4	P3-Y210N	LINK-BELT	PB 0014-2	PASE 50	INA	PB 0183-3	PL3-U220N	LINK-BELT	PB 0095-1
P3-S216E	LINK-BELT	PB 0060-4	P3-Y211N	LINK-BELT	PB 0020-2	PASE 55	INA	PB 0210-3	PL3-U222N	LINK-BELT	PB 0109-1
P3-S218E	LINK-BELT	PB 0072-4	P3-Y212N	LINK-BELT	PB 0025-2	PASE 7/8"	INA	PB 0040-3	PL3-U223N	LINK-BELT	PB 0123-1
P3-S219E	LINK-BELT	PB 0086-4	P3-Y214N	LINK-BELT	PB 0040-2	PASEY 20	INA	PB 0029-4	PL3-U224N	LINK-BELT	PB 0128-1
P3-S220E	LINK-BELT	PB 0096-4	P3-Y215N	LINK-BELT	PB 0046-2	PASEY 25	INA	PB 0052-4	PL3-U226N	LINK-BELT	PB 0145-1
P3-S222E	LINK-BELT	PB 0110-4	P3-Y216N	LINK-BELT	PB 0060-2	PASEY 30	INA	PB 0078-4	PL3-U227N	LINK-BELT	PB 0150-1
P3-S223E	LINK-BELT	PB 0124-4	P3-Y218N	LINK-BELT	PB 0072-2	PASEY 35	INA	PB 0116-4	PL3-U228N	LINK-BELT	PB 0155-1
P3-S224E	LINK-BELT	PB 0129-4	P3-Y219N	LINK-BELT	PB 0086-2	PASEY 40	INA	PB 0139-4	PL3-U231N	LINK-BELT	PB 0177-1
P3-S2E20E	LINK-BELT	PB 0093-4	P3-Y220N	LINK-BELT	PB 0096-2	PB 1 1/16"	INA	PB 0064-1	PL3-U232N	LINK-BELT	PB 0192-1
P3-U210N	LINK-BELT	PB 0014-1	P3-Y222N	LINK-BELT	PB 0110-2	PB 1 1/4"-206	INA	PB 0090-1	PL3-U235N	LINK-BELT	PB 0216-1
P3-U211N	LINK-BELT	PB 0020-1	P3-Y223N	LINK-BELT	PB 0124-2	PB 1 1/8"	INA	PB 0070-1	PL3-U236N	LINK-BELT	PB 0221-1
P3-U212N	LINK-BELT	PB 0025-1	P3-Y224N	LINK-BELT	PB 0129-2	PB 1 3/16"	INA	PB 0084-1	PL3-U238N	LINK-BELT	PB 0238-1
P3-U214N	LINK-BELT	PB 0040-1	P3-Y226N	LINK-BELT	PB 0146-2	PB 1"	INA	PB 0058-1	PL3-U239N	LINK-BELT	PB 0243-1
P3-U215N	LINK-BELT	PB 0046-1	P3-Y227N	LINK-BELT	PB 0151-2	PB 1/2"	INA	PB 0004-1	PL3-U2E20N	LINK-BELT	PB 0092-1
P3-U216N	LINK-BELT	PB 0060-1	P3-Y228N	LINK-BELT	PB 0156-2	PB 12	INA	PB 0001-1	PL3-U2E32N	LINK-BELT	PB 0189-1
P3-U218N	LINK-BELT	PB 0072-1	P3-Y231N	LINK-BELT	PB 0178-2	PB 15	INA	PB 0010-1	PL3-U2M20N	LINK-BELT	PB 0028-1
P3-U219N	LINK-BELT	PB 0086-1	P3-Y232N	LINK-BELT	PB 0193-2	PB 17	INA	PB 0016-1	PL3-U2M25N	LINK-BELT	PB 0051-1
P3-U220N	LINK-BELT	PB 0096-1	P3-Y235N	LINK-BELT	PB 0217-2	PB 20	INA	PB 0026-1	PL3-U2M30N	LINK-BELT	PB 0077-1
P3-U222N	LINK-BELT	PB 0110-1	P3-Y236N	LINK-BELT	PB 0222-2	PB 25	INA	PB 0050-1	PL3-U2M35N	LINK-BELT	PB 0115-1
P3-U223N	LINK-BELT	PB 0124-1	P3-Y238N	LINK-BELT	PB 0239-2	PB 3/4"	INA	PB 0022-1	PL3-U2M40N	LINK-BELT	PB 0138-1
P3-U224N	LINK-BELT	PB 0129-1	P3-Y239N	LINK-BELT	PB 0244-2	PB 30	INA	PB 0076-1	PL3-U2M45N	LINK-BELT	PB 0160-1
P3-U226N	LINK-BELT	PB 0146-1	P3-Y2B08N	LINK-BELT	PB 0005-2	PB 5/8"	INA	PB 0013-1	PL3-U2M50N	LINK-BELT	PB 0182-1
P3-U227N	LINK-BELT	PB 0151-1	P3-Y2E20N	LINK-BELT	PB 0093-2	PB 7/8"	INA	PB 0038-1	PL3-U2M55N	LINK-BELT	PB 0209-1

BY PART NUMBER

Part No.	Brand	Group No.	Part No.	Brand	Group No.	Part No.	Brand	Group No.	Part No.	Brand	Group No.
PL3-U2M60N	LINK-BELT	PB 0231-1	RAK 3/4"	INA	PB 0024-2	RAKY 50	INA	PB 0182-1	RASC-2-1/8	FAFNIR	PB 0205-1
PL3-W212U	LINK-BELT	PB 0024-3	RAK 30	INA	PB 0077-2	RAKY 55	INA	PB 0209-1	RASC-2-15/16	FAFNIR	PB 0288-1
PL3-W214U	LINK-BELT	PB 0039-3	RAK 35	INA	PB 0115-2	RAKY 60	INA	PB 0231-1	RASC-2-3/16	FAFNIR	PB 0217-1
PL3-W215U	LINK-BELT	PB 0045-3	RAK 40	INA	PB 0138-2	RAKY 7/8"	INA	PB 0039-1	RASC-2-3/8	FAFNIR	PB 0239-1
PL3-W216U	LINK-BELT	PB 0059-3	RAK 45	INA	PB 0160-2	RAKY 75	INA	PB 0291-1	RASC-25	FAFNIR	PB 0052-1
PL3-W218E	LINK-BELT	PB 0071-3	RAK 50	INA	PB 0182-2	RAS-1	FAFNIR	PB 0060-2	RASC-2-5/16	FAFNIR	PB 0227-1
PL3-W219E	LINK-BELT	PB 0085-3	RAK 55	INA	PB 0209-2	RAS-1-1/16	FAFNIR	PB 0066-2	RASC-2-7/16	FAFNIR	PB 0244-1
PL3-W220E	LINK-BELT	PB 0095-3	RAK 60	INA	PB 0231-2	RAS-1-1/2	FAFNIR	PB 0129-2	RASC-2S	FAFNIR	PB 0190-1
PL3-W222E	LINK-BELT	PB 0109-3	RAK 7/8"	INA	PB 0039-2	RAS-1-1/4	FAFNIR	PB 0096-2	RASC-3/4	FAFNIR	PB 0025-1
PL3-W223E	LINK-BELT	PB 0123-3	RAK 75 S	INA	PB 0291-2	RAS-1-1/8	FAFNIR	PB 0072-2	RASC-30	FAFNIR	PB 0078-1
PL3-W224E	LINK-BELT	PB 0128-3	RAK-1	FAFNIR	PB 0059-2	RAS-1-11/16	FAFNIR	PB 0151-2	RASC-35	FAFNIR	PB 0116-1
PL3-W226U	LINK-BELT	PB 0145-3	RAK-1-1/16	FAFNIR	PB 0065-2	RAS-1-13/16	FAFNIR	PB 0168-2	RASC-40	FAFNIR	PB 0139-1
PL3-W227U	LINK-BELT	PB 0150-3	RAK-1-1/2	FAFNIR	PB 0128-2	RAS-1-15/16	FAFNIR	PB 0178-2	RASC-45	FAFNIR	PB 0161-1
PL3-W228U	LINK-BELT	PB 0155-3	RAK-1-1/4	FAFNIR	PB 0095-2	RAS-13/16	FAFNIR	PB 0034-2	RASC-50	FAFNIR	PB 0183-1
PL3-W231U	LINK-BELT	PB 0177-3	RAK-1-1/8	FAFNIR	PB 0071-2	RAS-1-3/16	FAFNIR	PB 0086-2	RASC-55	FAFNIR	PB 0210-1
PL3-W2E20E	LINK-BELT	PB 0092-3	RAK-1-11/16	FAFNIR	PB 0150-2	RAS-1-3/4	FAFNIR	PB 0156-2	RASC-60	FAFNIR	PB 0232-1
PL3-W2E32U	LINK-BELT	PB 0189-3	RAK-1-13/16	FAFNIR	PB 0167-2	RAS-1-3/8	FAFNIR	PB 0110-2	RASC-7/8	FAFNIR	PB 0040-1
PL3-Y212N	LINK-BELT	PB 0024-2	RAK-1-15/16	FAFNIR	PB 0177-2	RAS-15/16	FAFNIR	PB 0046-2	RASC-75	FAFNIR	PB 0292-1
PL3-Y214N	LINK-BELT	PB 0039-2	RAK-13/16	FAFNIR	PB 0033-2	RAS-1-5/16	FAFNIR	PB 0104-2	RASE 1 1/2"	INA	PB 0129-2
PL3-Y215N	LINK-BELT	PB 0045-2	RAK-1-3/16	FAFNIR	PB 0085-2	RAS-1-5/8	FAFNIR	PB 0146-2	RASE 1 1/4"	INA	PB 0096-2
PL3-Y216N	LINK-BELT	PB 0059-2	RAK-1-3/4	FAFNIR	PB 0155-2	RAS-1-7/16	FAFNIR	PB 0124-2	RASE 1 1/4"-206	INA	PB 0093-2
PL3-Y218N	LINK-BELT	PB 0071-2	RAK-1-3/8	FAFNIR	PB 0109-2	RAS-1-7/8	FAFNIR	PB 0173-2	RASE 1 1/8"	INA	PB 0072-2
PL3-Y219N	LINK-BELT	PB 0085-2	RAK-15/16	FAFNIR	PB 0045-2	RAS-1-9/16	FAFNIR	PB 0134-2	RASE 1 11/16"	INA	PB 0151-2
PL3-Y220N	LINK-BELT	PB 0095-2	RAK-1-5/16	FAFNIR	PB 0103-2	RAS-2	FAFNIR	PB 0193-2	RASE 1 15/16"	INA	PB 0178-2
PL3-Y222N	LINK-BELT	PB 0109-2	RAK-1-5/8	FAFNIR	PB 0145-2	RAS-20	FAFNIR	PB 0029-2	RASE 1 3/16"	INA	PB 0086-2
PL3-Y223N	LINK-BELT	PB 0123-2	RAK-1-7/16	FAFNIR	PB 0123-2	RAS-2-1/16	FAFNIR	PB 0200-2	RASE 1 3/4"	INA	PB 0156-2
PL3-Y224N	LINK-BELT	PB 0128-2	RAK-1-7/8	FAFNIR	PB 0172-2	RAS-2-1/4	FAFNIR	PB 0222-2	RASE 1 3/8"	INA	PB 0110-2
PL3-Y226N	LINK-BELT	PB 0145-2	RAK-1-9/16	FAFNIR	PB 0133-2	RAS-2-1/8	FAFNIR	PB 0205-2	RASE 1 5/8"	INA	PB 0146-2
PL3-Y227N	LINK-BELT	PB 0150-2	RAK-2	FAFNIR	PB 0192-2	RAS-2-15/16	FAFNIR	PB 0288-2	RASE 1 7/16"	INA	PB 0124-2
PL3-Y228N	LINK-BELT	PB 0155-2	RAK-20	FAFNIR	PB 0028-2	RAS-2-3/16	FAFNIR	PB 0217-2	RASE 1"	INA	PB 0060-2
PL3-Y231N	LINK-BELT	PB 0177-2	RAK-2-1/16	FAFNIR	PB 0199-2	RAS-2-3/8	FAFNIR	PB 0239-2	RASE 15	INA	PB 0011-2
PL3-Y232N	LINK-BELT	PB 0192-2	RAK-2-1/4	FAFNIR	PB 0221-2	RAS-25	FAFNIR	PB 0052-2	RASE 15/16"	INA	PB 0046-2
PL3-Y235N	LINK-BELT	PB 0216-2	RAK-2-1/8	FAFNIR	PB 0204-2	RAS-2-5/16	FAFNIR	PB 0227-2	RASE 17	INA	PB 0017-2
PL3-Y236N	LINK-BELT	PB 0221-2	RAK-2-15/16	FAFNIR	PB 0287-2	RAS-2-7/16	FAFNIR	PB 0244-2	RASE 2 15/16" S	INA	PB 0288-2
PL3-Y238N	LINK-BELT	PB 0238-2	RAK-2-3/16	FAFNIR	PB 0216-2	RAS-3/4	FAFNIR	PB 0025-2	RASE 2 3/16"	INA	PB 0217-2
PL3-Y239N	LINK-BELT	PB 0243-2	RAK-2-3/8	FAFNIR	PB 0238-2	RAS-30	FAFNIR	PB 0078-2	RASE 2 7/16"	INA	PB 0244-2
PL3-Y2E20N	LINK-BELT	PB 0092-2	RAK-25	FAFNIR	PB 0051-2	RAS-35	FAFNIR	PB 0116-2	RASE 20	INA	PB 0029-2
PL3-Y2E32N	LINK-BELT	PB 0189-2	RAK-2-5/16	FAFNIR	PB 0226-2	RAS-40	FAFNIR	PB 0139-2	RASE 25	INA	PB 0052-2
PT3-U214N	LINK-BELT	PB 0041-1	RAK-2-7/16	FAFNIR	PB 0243-2	RAS-45	FAFNIR	PB 0161-2	RASE 3/4"	INA	PB 0025-2
PT3-U215N	LINK-BELT	PB 0047-1	RAK-3/4	FAFNIR	PB 0024-2	RAS-50	FAFNIR	PB 0183-2	RASE 30	INA	PB 0078-2
PT3-U216N	LINK-BELT	PB 0061-1	RAK-30	FAFNIR	PB 0077-2	RAS-55	FAFNIR	PB 0210-2	RASE 35	INA	PB 0116-2
PT3-U218N	LINK-BELT	PB 0073-1	RAK-35	FAFNIR	PB 0115-2	RAS-60	FAFNIR	PB 0232-2	RASE 40	INA	PB 0139-2
PT3-U219N	LINK-BELT	PB 0087-1	RAK-40	FAFNIR	PB 0138-2	RAS-7/8	FAFNIR	PB 0040-2	RASE 45	INA	PB 0161-2
PT3-U220N	LINK-BELT	PB 0097-1	RAK-45	FAFNIR	PB 0160-2	RAS-75	FAFNIR	PB 0292-2	RASE 5/8"	INA	PB 0014-2
PT3-U222N	LINK-BELT	PB 0111-1	RAK-50	FAFNIR	PB 0182-2	RASC-1	FAFNIR	PB 0060-1	RASE 50	INA	PB 0183-2
PT3-U223N	LINK-BELT	PB 0125-1	RAK-55	FAFNIR	PB 0209-2	RASC-1-1/16	FAFNIR	PB 0066-1	RASE 55	INA	PB 0210-2
PT3-U231N	LINK-BELT	PB 0179-1	RAK-60	FAFNIR	PB 0231-2	RASC-1-1/2	FAFNIR	PB 0129-1	RASE 60	INA	PB 0232-2
PT3-U2E20N	LINK-BELT	PB 0094-1	RAK-7/8	FAFNIR	PB 0039-2	RASC-1-1/4	FAFNIR	PB 0096-1	RASE 7/8"	INA	PB 0040-2
PT3-U2E32N	LINK-BELT	PB 0191-1	RAK-75	FAFNIR	PB 0291-2	RASC-1-1/4S	FAFNIR	PB 0093-1	RASE 70 S	INA	PB 0276-2
RAK 1 1/2"	INA	PB 0128-2	RAKY 1 1/2"	INA	PB 0128-1	RASC-1-1/8	FAFNIR	PB 0072-1	RASE 75 S	INA	PB 0292-2
RAK 1 1/4"	INA	PB 0095-2	RAKY 1 1/4"	INA	PB 0095-1	RASC-1-11/16	FAFNIR	PB 0151-1	RASEY 1 1/2"	INA	PB 0129-1
RAK 1 1/4"-206	INA	PB 0092-2	RAKY 1 1/4"-206	INA	PB 0092-1	RASC-1-13/16	FAFNIR	PB 0168-1	RASEY 1 1/2"-MP	INA	PB 0131-1
RAK 1 1/8"	INA	PB 0071-2	RAKY 1 1/8"	INA	PB 0071-1	RASC-1-15/16	FAFNIR	PB 0178-1	RASEY 1 1/4"	INA	PB 0096-1
RAK 1 11/16"	INA	PB 0150-2	RAKY 1 15/16"	INA	PB 0177-1	RASC-13/16	FAFNIR	PB 0034-1	RASEY 1 1/4"-206	INA	PB 0093-1
RAK 1 15/16"	INA	PB 0177-2	RAKY 1 3/4"	INA	PB 0155-1	RASC-1-3/16	FAFNIR	PB 0086-1	RASEY 1 1/8"	INA	PB 0072-1
RAK 1 3/16"	INA	PB 0085-2	RAKY 1 3/8"	INA	PB 0109-1	RASC-1-3/4	FAFNIR	PB 0156-1	RASEY 1 15/16"	INA	PB 0178-1
RAK 1 3/4"	INA	PB 0155-2	RAKY 1"	INA	PB 0059-1	RASC-1-3/8	FAFNIR	PB 0110-1	RASEY 1 3/4"	INA	PB 0156-1
RAK 1 3/8"	INA	PB 0109-2	RAKY 2 15/16"	INA	PB 0287-1	RASC-15/16	FAFNIR	PB 0046-1	RASEY 1 3/4"-MP	INA	PB 0158-1
RAK 1 5/8"	INA	PB 0145-2	RAKY 2 7/16"	INA	PB 0243-1	RASC-1-5/16	FAFNIR	PB 0104-1	RASEY 1 3/8"	INA	PB 0110-1
RAK 1 7/16"	INA	PB 0123-2	RAKY 2"	INA	PB 0192-1	RASC-1-5/8	FAFNIR	PB 0146-1	RASEY 1"	INA	PB 0060-1
RAK 1"	INA	PB 0059-2	RAKY 20	INA	PB 0028-1	RASC-1-7/16	FAFNIR	PB 0124-1	RASEY 1/2"	INA	PB 0005-1
RAK 15/16"	INA	PB 0045-2	RAKY 25	INA	PB 0051-1	RASC-1-7/8	FAFNIR	PB 0173-1	RASEY 12	INA	PB 0002-1
RAK 2 15/16" S	INA	PB 0287-2	RAKY 3/4"	INA	PB 0024-1	RASC-1-9/16	FAFNIR	PB 0134-1	RASEY 15	INA	PB 0011-1
RAK 2 3/16"	INA	PB 0216-2	RAKY 30	INA	PB 0077-1	RASC-2	FAFNIR	PB 0193-1	RASEY 17	INA	PB 0017-1
RAK 2 7/16"	INA	PB 0243-2	RAKY 35	INA	PB 0115-1	RASC-20	FAFNIR	PB 0029-1	RASEY 2 1/2"-213	INA	PB 0249-1
RAK 20	INA	PB 0028-2	RAKY 40	INA	PB 0138-1	RASC-2-1/16	FAFNIR	PB 0200-1	RASEY 2 1/2"-MP	INA	PB 0251-1
RAK 25	INA	PB 0051-2	RAKY 45	INA	PB 0160-1	RASC-2-1/4	FAFNIR	PB 0222-1	RASEY 2 15/16"	INA	PB 0288-1

BY PART NUMBER

Part No.	Brand	Group No.	Part No.	Brand	Group No.	Part No.	Brand	Group No.	Part No.	Brand	Group No.
RASEY 2 7/16"	INA	PB 0244-1	SAAK 205-14	SLB	PB 0039-3	SAPP 201F	FYH	PB 0001-1	SBAK 205	SLB	PB 0051-4
RASEY 2"	INA	PB 0193-4	SAAK 205-15	SLB	PB 0045-3	SAPP 202	SLB	PB 0010-1	SBAK 205-13	SLB	PB 0033-4
RASEY 2"-MP	INA	PB 0195-1	SAAK 205-16	SLB	PB 0059-3	SAPP 202-10	SLB	PB 0013-1	SBAK 205-14	SLB	PB 0039-4
RASEY 20	INA	PB 0029-1	SAAK 206	SLB	PB 0077-3	SAPP 202-10F	FYH	PB 0013-1	SBAK 205-15	SLB	PB 0045-4
RASEY 25	INA	PB 0052-1	SAAK 206-17	SLB	PB 0065-3	SAPP 202-9	SLB	PB 0007-1	SBAK 205-16	SLB	PB 0059-4
RASEY 3/4"	INA	PB 0025-1	SAAK 206-18	SLB	PB 0071-3	SAPP 202F	FYH	PB 0010-1	SBAK 206	SLB	PB 0077-4
RASEY 30	INA	PB 0078-1	SAAK 206-19	SLB	PB 0085-3	SAPP 203	SLB	PB 0016-1	SBAK 206-17	SLB	PB 0065-4
RASEY 35	INA	PB 0116-1	SAAK 206-20	SLB	PB 0092-3	SAPP 203-11	SLB	PB 0019-1	SBAK 206-18	SLB	PB 0071-4
RASEY 40	INA	PB 0139-1	SAAK 207	SLB	PB 0115-3	SAPP 203F	FYH	PB 0016-1	SBAK 206-19	SLB	PB 0085-4
RASEY 40-MP	INA	PB 0143-1	SAAK 207-20	SLB	PB 0095-3	SAPP 204	SLB	PB 0026-1	SBAK 206-20	SLB	PB 0092-4
RASEY 45	INA	PB 0161-1	SAAK 207-21	SLB	PB 0103-3	SAPP 204-12	SLB	PB 0022-1	SBAK 207	SLB	PB 0115-4
RASEY 45-MP	INA	PB 0165-1	SAAK 207-22	SLB	PB 0109-3	SAPP 204-12F	FYH	PB 0022-1	SBAK 207-20	SLB	PB 0095-4
RASEY 5/8"	INA	PB 0014-1	SAAK 207-23	SLB	PB 0123-3	SAPP 204F	FYH	PB 0026-1	SBAK 207-21	SLB	PB 0103-4
RASEY 50	INA	PB 0183-1	SAAK 208	SLB	PB 0138-3	SAPP 205	SLB	PB 0050-1	SBAK 207-22	SLB	PB 0109-4
RASEY 50-MP	INA	PB 0187-1	SAAK 208-24	SLB	PB 0128-3	SAPP 205-13	SLB	PB 0032-1	SBAK 207-23	SLB	PB 0123-4
RASEY 55	INA	PB 0210-1	SAAK 208-25	SLB	PB 0133-3	SAPP 205-14	SLB	PB 0038-1	SBAK 208	SLB	PB 0138-4
RASEY 60	INA	PB 0232-1	SAAK 209	SLB	PB 0160-3	SAPP 205-14F	FYH	PB 0038-1	SBAK 208-24	SLB	PB 0128-4
RASEY 60-MP	INA	PB 0236-1	SAAK 209-26	SLB	PB 0145-3	SAPP 205-15	SLB	PB 0044-1	SBP 204	SLB	PB 0029-4
RASEY 65-213	INA	PB 0254-1	SAAK 209-27	SLB	PB 0150-3	SAPP 205-16	SLB	PB 0058-1	SBP 204-12	SLB	PB 0025-4
RASEY 7/8"	INA	PB 0040-1	SAAK 209-28	SLB	PB 0155-3	SAPP 205-16F	FYH	PB 0058-1	SBP 205	SLB	PB 0052-4
RASEY 70	INA	PB 0276-1	SAAK 210	SLB	PB 0182-3	SAPP 205F	FYH	PB 0050-1	SBP 205-14	SLB	PB 0040-4
RASEY 75	INA	PB 0292-1	SAAK 210-29	SLB	PB 0167-3	SAPP 206	SLB	PB 0076-1	SBP 205-15	SLB	PB 0046-4
RASEY 80	INA	PB 0305-1	SAAK 210-30	SLB	PB 0172-3	SAPP 206-17	SLB	PB 0064-1	SBP 205-16	SLB	PB 0060-4
RASEY 90	INA	PB 0314-1	SAAK 210-31	SLB	PB 0177-3	SAPP 206-18	SLB	PB 0070-1	SBP 206	SLB	PB 0078-4
RSAOY 30	INA	PB 0083-1	SAAK 210-32	SLB	PB 0189-3	SAPP 206-18F	FYH	PB 0070-1	SBP 206-18	SLB	PB 0072-4
RSAOY 40	INA	PB 0144-1	SAAK 211	SLB	PB 0209-3	SAPP 206-19	SLB	PB 0084-1	SBP 206-19	SLB	PB 0086-4
RSAOY 50	INA	PB 0188-1	SAAK 211-32	SLB	PB 0192-3	SAPP 206-19F	FYH	PB 0084-1	SBP 206-20	SLB	PB 0093-4
RSAOY 60	INA	PB 0237-1	SAAK 211-33	SLB	PB 0199-3	SAPP 206-20	SLB	PB 0090-1	SBP 207	SLB	PB 0116-4
RSHEY 1 1/2"	INA	PB 0130-1	SAAK 211-34	SLB	PB 0204-3	SAPP 206-20F	FYH	PB 0090-1	SBP 207-20	SLB	PB 0096-4
RSHEY 1 1/4"	INA	PB 0097-1	SAAK 211-35	SLB	PB 0216-3	SAPP 206F	FYH	PB 0076-1	SBP 207-21	SLB	PB 0104-4
RSHEY 1 1/4"-206	INA	PB 0094-1	SAP 204	SLB	PB 0029-3	SAPP 207	SLB	PB 0114-1	SBP 207-22	SLB	PB 0110-4
RSHEY 1 1/8"	INA	PB 0073-1	SAP 204-12	SLB	PB 0025-3	SAPP 207-20	SLB	PB 0091-1	SBP 207-23	SLB	PB 0124-4
RSHEY 1 15/16"	INA	PB 0179-1	SAP 205	SLB	PB 0052-3	SAPP 207-21	SLB	PB 0102-1	SBP 208	SLB	PB 0139-4
RSHEY 1 3/4"	INA	PB 0157-1	SAP 205-13	SLB	PB 0034-3	SAPP 207-22	SLB	PB 0108-1	SBP 208-24	SLB	PB 0129-4
RSHEY 1 3/8"	INA	PB 0111-1	SAP 205-14	SLB	PB 0040-3	SAPP 207-23	SLB	PB 0122-1	SBPP 201	SLB	PB 0001-2
RSHEY 1"	INA	PB 0061-1	SAP 205-15	SLB	PB 0046-3	SAS-1	FAFNIR	PB 0060-4	SBPP 201-8	SLB	PB 0004-2
RSHEY 1/2"	INA	PB 0006-1	SAP 205-16	SLB	PB 0060-3	SAS-1-1/2	FAFNIR	PB 0129-4	SBPP 201-8F	FYH	PB 0004-2
RSHEY 2"	INA	PB 0194-1	SAP 206	SLB	PB 0078-3	SAS-1-1/4	FAFNIR	PB 0096-4	SBPP 201F	FYH	PB 0001-2
RSHEY 5/8"	INA	PB 0015-1	SAP 206-17	SLB	PB 0066-3	SAS-1-1/4S	FAFNIR	PB 0093-4	SBPP 202	SLB	PB 0010-2
RSHEY 7/8"	INA	PB 0041-1	SAP 206-18	SLB	PB 0072-3	SAS-1-1/8	FAFNIR	PB 0072-4	SBPP 202-10	SLB	PB 0013-2
			SAP 206-19	SLB	PB 0086-3	SAS-1-3/16	FAFNIR	PB 0086-4	SBPP 202-10F	FYH	PB 0013-2
			SAP 206-20	SLB	PB 0093-3	SAS-1-3/8	FAFNIR	PB 0110-4	SBPP 202-9	SLB	PB 0007-2
S 1/2 FM	SKF	PB 0004-1	SAP 207	SLB	PB 0116-3	SAS-15/16	FAFNIR	PB 0046-4	SBPP 202F	FYH	PB 0010-2
S 11/16 FM	SKF	PB 0019-1	SAP 207-20	SLB	PB 0096-3	SAS-1-7/16	FAFNIR	PB 0124-4	SBPP 203	SLB	PB 0016-2
S 1-1/16 FM	SKF	PB 0064-1	SAP 207-21	SLB	PB 0104-3	SAS-20	FAFNIR	PB 0029-4	SBPP 203-11	SLB	PB 0019-2
S 1-1/4 AFM	SKF	PB 0090-1	SAP 207-22	SLB	PB 0110-3	SAS-25	FAFNIR	PB 0052-4	SBPP 203F	FYH	PB 0016-2
S 1-1/4 FM	SKF	PB 0091-1	SAP 207-23	SLB	PB 0124-3	SAS-3/4	FAFNIR	PB 0025-4	SBPP 204	SLB	PB 0026-2
S 1-1/8 FM	SKF	PB 0070-1	SAP 208	SLB	PB 0139-3	SAS-30	FAFNIR	PB 0078-4	SBPP 204-12	SLB	PB 0022-2
S 12 FM	SKF	PB 0001-1	SAP 208-24	SLB	PB 0129-3	SAS-35	FAFNIR	PB 0116-4	SBPP 204-12F	FYH	PB 0022-2
S 13/16 FM	SKF	PB 0032-1	SAP 208-25	SLB	PB 0134-3	SAS-40	FAFNIR	PB 0139-4	SBPP 204F	FYH	PB 0026-2
S 1-3/16 FM	SKF	PB 0084-1	SAP 209	SLB	PB 0161-3	SAS-7/8	FAFNIR	PB 0040-4	SBPP 205	SLB	PB 0050-2
S 1-3/8 FM	SKF	PB 0108-1	SAP 209-26	SLB	PB 0146-3	SB16203	FAG	PB 0016-1	SBPP 205-13	SLB	PB 0032-2
S 15 FM	SKF	PB 0010-1	SAP 209-27	SLB	PB 0151-3	SB16203/15	FAG	PB 0010-1	SBPP 205-14	SLB	PB 0038-2
S 15/16 FM	SKF	PB 0044-1	SAP 209-28	SLB	PB 0156-3	SB16204	FAG	PB 0026-1	SBPP 205-14F	FYH	PB 0038-2
S 1-5/16 FM	SKF	PB 0102-1	SAP 210	SLB	PB 0183-3	SB16204.012	FAG	PB 0022-1	SBPP 205-15	SLB	PB 0044-2
S 17 FM	SKF	PB 0016-1	SAP 210-29	SLB	PB 0168-3	SB16205	FAG	PB 0050-1	SBPP 205-16	SLB	PB 0058-2
S 1-7/16 FM	SKF	PB 0122-1	SAP 210-30	SLB	PB 0173-3	SB16205.014	FAG	PB 0038-1	SBPP 205-16F	FYH	PB 0058-2
S 20 FM	SKF	PB 0026-1	SAP 210-31	SLB	PB 0178-3	SB16205.100	FAG	PB 0058-1	SBPP 205F	FYH	PB 0050-2
S 25 FM	SKF	PB 0050-1	SAP 210-32	SLB	PB 0190-3	SB16206	FAG	PB 0076-1	SBPP 206	SLB	PB 0076-2
S 3/4 FM	SKF	PB 0022-1	SAP 211	SLB	PB 0210-3	SB16206.101	FAG	PB 0064-1	SBPP 206-17	SLB	PB 0064-2
S 30 FM	SKF	PB 0076-1	SAP 211-32	SLB	PB 0193-3	SB16206.102	FAG	PB 0070-1	SBPP 206-18	SLB	PB 0070-2
S 35 FM	SKF	PB 0114-1	SAP 211-33	SLB	PB 0200-3	SB16206.103	FAG	PB 0084-1	SBPP 206-18F	FYH	PB 0070-2
S 5/8 FM	SKF	PB 0013-1	SAP 211-34	SLB	PB 0205-3	SB16206.104	FAG	PB 0090-1	SBPP 206-19	FYH	PB 0084-2
S 7/8 FM	SKF	PB 0038-1	SAP 211-35	SLB	PB 0217-3	SB16207	FAG	PB 0114-1	SBPP 206-19F	FYH	PB 0084-2
SAAK 204	SLB	PB 0028-3	SAPP 201	SLB	PB 0001-1	SB16207.106	FAG	PB 0108-1	SBPP 206-20	SLB	PB 0090-2
SAAK 204-12	SLB	PB 0024-3	SAPP 201-8	SLB	PB 0004-1	SB16207.106	FAG	PB 0108-1	SBPP 206F	FYH	PB 0076-2
SAAK 205	SLB	PB 0051-3	SAPP 201-8F	FYH	PB 0004-1	SBAK 204	SLB	PB 0028-4	SBPP 207	SLB	PB 0114-2
SAAK 205-13	SLB	PB 0033-3				SBAK 204-12	SLB	PB 0024-4			

BY PART NUMBER

Part No.	Brand	Group No.	Part No.	Brand	Group No.	Part No.	Brand	Group No.	Part No.	Brand	Group No.
SBPP 207-20	SLB	PB 0091-2	SL 208-25	FYH	PB 0133-1	SL2 1/4	RHP	PB 0221-1	SL60	RHP	PB 0231-1
SBPP 207-21	SLB	PB 0102-2	SL 209	FYH	PB 0160-1	SL2 1/4DEC	RHP	PB 0221-2	SL60	SNR	PB 0231-1
SBPP 207-22	SLB	PB 0108-2	SL 209-26	FYH	PB 0145-1	SL2 1/8	RHP	PB 0204-1	SL60DEC	RHP	PB 0231-2
SBPP 207-23	SLB	PB 0122-2	SL 209-27	FYH	PB 0150-1	SL2 1/8DEC	RHP	PB 0204-2	SL65	RHP	PB 0253-1
SG16204	FAG	PB 0029-3	SL 209-28	FYH	PB 0155-1	SL2 11/16	RHP	PB 0267-1	SL65DEC	RHP	PB 0253-2
SG16204.012	FAG	PB 0025-3	SL 210	FYH	PB 0182-1	SL2 11/16DEC	RHP	PB 0267-2	SL7/8	RHP	PB 0039-1
SG16205	FAG	PB 0052-3	SL 210-30	FYH	PB 0172-1	SL2 15/16	RHP	PB 0287-1	SL7/8DEC	RHP	PB 0039-2
SG16205.014	FAG	PB 0040-3	SL 210-31	FYH	PB 0177-1	SL2 15/16DEC	RHP	PB 0287-2	SL7/8EC	RHP	PB 0039-3
SG16205.100	FAG	PB 0060-3	SL 211	FYH	PB 0209-1	SL2 3/16	RHP	PB 0216-1	SL70	RHP	PB 0275-1
SG16206	FAG	PB 0078-3	SL 211-32	FYH	PB 0192-1	SL2 3/16DEC	RHP	PB 0216-2	SL70DEC	RHP	PB 0275-2
SG16206.101	FAG	PB 0066-3	SL 211-34	FYH	PB 0204-1	SL2 3/4	RHP	PB 0271-1	SL75	RHP	PB 0291-1
SG16206.102	FAG	PB 0072-3	SL 211-35	FYH	PB 0216-1	SL2 3/4DEC	RHP	PB 0271-2	SL75DEC	RHP	PB 0291-2
SG16206.103	FAG	PB 0086-3	SL 212	FYH	PB 0231-1	SL2 3/8	RHP	PB 0238-1	SN15/16	RHP	PB 0047-1
SG16206.104	FAG	PB 0093-3	SL 212-36	FYH	PB 0221-1	SL2 3/8DEC	RHP	PB 0238-2	SNP1	RHP	PB 0061-1
SG16207	FAG	PB 0116-3	SL 212-38	FYH	PB 0238-1	SL2 7/16	RHP	PB 0243-1	SNP1 1/2	RHP	PB 0130-1
SG16207.106	FAG	PB 0110-3	SL 212-39	FYH	PB 0243-1	SL2 7/16DEC	RHP	PB 0243-2	SNP1 1/4	RHP	PB 0097-1
SG16208	FAG	PB 0134-3	SL 215	FYH	PB 0291-1	SL2 7/8	RHP	PB 0283-1	SNP1 1/4R	RHP	PB 0094-1
SG16208.108	FAG	PB 0124-3	SL 215-48	FYH	PB 0295-1	SL2 7/8DEC	RHP	PB 0283-2	SNP1 1/8	RHP	PB 0073-1
SG16209	FAG	PB 0156-3	SL1	RHP	PB 0059-1	SL20	RHP	PB 0028-1	SNP1 11/16	RHP	PB 0152-1
SG16209.112	FAG	PB 0151-3	SL1 1/2	RHP	PB 0128-1	SL20	SNR	PB 0028-1	SNP1 15/16	RHP	PB 0179-1
SG16210	FAG	PB 0178-3	SL1 1/2A	RHP	PB 0128-4	SL20A	RHP	PB 0028-4	SNP1 3/16	RHP	PB 0087-1
SG36204B	FAG	PB 0025-2	SL1 1/2DEC	RHP	PB 0128-2	SL20DEC	RHP	PB 0028-2	SNP1 3/4	RHP	PB 0157-1
SG36205B	FAG	PB 0046-2	SL1 1/2EC	RHP	PB 0128-3	SL20EC	RHP	PB 0028-3	SNP1 3/8	RHP	PB 0111-1
SG36206B	FAG	PB 0072-2	SL1 1/4	RHP	PB 0095-1	SL20EC	SNR	PB 0028-3	SNP1 5/8	RHP	PB 0147-1
SG36207B	FAG	PB 0110-2	SL1 1/4A	RHP	PB 0095-4	SL25	RHP	PB 0051-1	SNP1 7/16	RHP	PB 0125-1
SG36208B	FAG	PB 0134-2	SL1 1/4AR	RHP	PB 0092-4	SL25	SNR	PB 0051-1	SNP1 7/8	RHP	PB 0174-1
SG36209B	FAG	PB 0156-2	SL1 1/4DEC	RHP	PB 0095-2	SL25A	RHP	PB 0051-4	SNP2	RHP	PB 0194-1
SG36210B	FAG	PB 0178-2	SL1 1/4DECR	RHP	PB 0092-2	SL25DEC	RHP	PB 0051-2	SNP2 1/4	RHP	PB 0223-1
SG56204	FAG	PB 0029-1	SL1 1/4EC	RHP	PB 0095-3	SL25EC	RHP	PB 0051-3	SNP2 1/8	RHP	PB 0206-1
SG56204.012	FAG	PB 0025-1	SL1 1/4ECR	RHP	PB 0092-3	SL25EC	SNR	PB 0051-3	SNP2 3/16	RHP	PB 0218-1
SG56205	FAG	PB 0052-1	SL1 1/4R	RHP	PB 0092-1	SL2DEC	RHP	PB 0192-2	SNP2 3/8	RHP	PB 0240-1
SG56205.100	FAG	PB 0060-1	SL1 1/8	RHP	PB 0071-1	SL2R	RHP	PB 0189-1	SNP2 7/16	RHP	PB 0245-1
SG56206	FAG	PB 0078-1	SL1 1/8DEC	RHP	PB 0071-2	SL3/4	RHP	PB 0024-1	SNP20	RHP	PB 0027-1
SG56206.102	FAG	PB 0072-1	SL1 1/8EC	RHP	PB 0071-3	SL3/4A	RHP	PB 0024-4	SNP25	RHP	PB 0053-1
SG56206.103	FAG	PB 0086-1	SL1 11/16	RHP	PB 0150-1	SL3/4DEC	RHP	PB 0024-2	SNP25	SNR	PB 0053-1
SG56207	FAG	PB 0116-1	SL1 11/16DEC	RHP	PB 0150-2	SL3/4EC	RHP	PB 0024-3	SNP2R	RHP	PB 0191-1
SG56207.104	FAG	PB 0096-1	SL1 11/16EC	RHP	PB 0150-3	SL30	RHP	PB 0077-1	SNP3/4	RHP	PB 0023-1
SG56207.106	FAG	PB 0110-1	SL1 15/16	RHP	PB 0177-1	SL30	SNR	PB 0077-1	SNP30	RHP	PB 0079-1
SG56207.107	FAG	PB 0124-1	SL1 15/16DEC	RHP	PB 0177-2	SL30A	RHP	PB 0077-4	SNP30	SNR	PB 0079-1
SG56208	FAG	PB 0139-1	SL1 15/16EC	RHP	PB 0177-3	SL30DEC	RHP	PB 0077-2	SNP35	RHP	PB 0117-1
SG56208.108	FAG	PB 0129-1	SL1 3/16	RHP	PB 0085-1	SL30EC	RHP	PB 0077-3	SNP35	SNR	PB 0117-1
SG56209	FAG	PB 0161-1	SL1 3/16DEC	RHP	PB 0085-2	SL30EC	SNR	PB 0077-3	SNP40	RHP	PB 0140-1
SG56209.112	FAG	PB 0156-1	SL1 3/16EC	RHP	PB 0085-3	SL35	RHP	PB 0115-1	SNP40	SNR	PB 0140-1
SG56210	FAG	PB 0183-1	SL1 3/4	RHP	PB 0155-1	SL35	SNR	PB 0115-1	SNP45	RHP	PB 0162-1
SG56210.115	FAG	PB 0178-1	SL1 3/4DEC	RHP	PB 0155-2	SL35A	RHP	PB 0115-4	SNP50	RHP	PB 0184-1
SG56211	FAG	PB 0210-1	SL1 3/4EC	RHP	PB 0155-3	SL35DEC	RHP	PB 0115-2	SNP50	SNR	PB 0184-1
SG56211.200	FAG	PB 0193-1	SL1 3/8	RHP	PB 0109-1	SL35EC	RHP	PB 0115-3	SNP55	RHP	PB 0211-1
SG56211.203	FAG	PB 0217-1	SL1 3/8DEC	RHP	PB 0109-2	SL35EC	SNR	PB 0115-3	SNP60	RHP	PB 0233-1
SG56212	FAG	PB 0232-1	SL1 3/8EC	RHP	PB 0109-3	SL40	RHP	PB 0138-1	SNP7/8	RHP	PB 0041-1
SG56212.204	FAG	PB 0222-1	SL1 5/8	RHP	PB 0145-1	SL40	SNR	PB 0138-1	SP 010 A	KOYO	PB 0013-1
SG56212.207	FAG	PB 0244-1	SL1 5/8DEC	RHP	PB 0145-2	SL40A	RHP	PB 0138-4	SP 011 MA	KOYO	PB 0016-1
SL 204	FYH	PB 0028-1	SL1 5/8EC	RHP	PB 0145-3	SL40DEC	RHP	PB 0138-2	SP 012 A	KOYO	PB 0022-1
SL 204-12	FYH	PB 0024-1	SL1 7/16	RHP	PB 0123-1	SL40EC	RHP	PB 0138-3	SP 012 MA	KOYO	PB 0026-1
SL 205	FYH	PB 0051-1	SL1 7/16DEC	RHP	PB 0123-2	SL40EC	SNR	PB 0138-3	SP 013 A	KOYO	PB 0032-1
SL 205-14	FYH	PB 0039-1	SL1 7/16EC	RHP	PB 0123-3	SL45	RHP	PB 0160-1	SP 014 A	KOYO	PB 0038-1
SL 205-15	FYH	PB 0045-1	SL1 7/8	RHP	PB 0172-1	SL45	SNR	PB 0160-1	SP 015 A	KOYO	PB 0044-1
SL 205-16	FYH	PB 0059-1	SL1 7/8DEC	RHP	PB 0172-2	SL45DEC	RHP	PB 0160-2	SP 100 A	KOYO	PB 0058-1
SL 206	FYH	PB 0077-1	SL1 7/8EC	RHP	PB 0172-3	SL45EC	RHP	PB 0160-3	SP 100 MA	KOYO	PB 0050-1
SL 206-18	FYH	PB 0071-1	SL15/16	RHP	PB 0045-1	SL45EC	SNR	PB 0160-3	SP 102 A	KOYO	PB 0070-1
SL 206-19	FYH	PB 0085-1	SL15/16DEC	RHP	PB 0045-2	SL50	RHP	PB 0182-1	SP 103 A	KOYO	PB 0084-1
SL 207	FYH	PB 0115-1	SL15/16EC	RHP	PB 0045-3	SL50	SNR	PB 0182-1	SP 103 A-1	KOYO	PB 0090-1
SL 207-20	FYH	PB 0095-1	SL1A	RHP	PB 0059-4	SL50DEC	RHP	PB 0182-2	SP 103 MA	KOYO	PB 0076-1
SL 207-21	FYH	PB 0103-1	SL1EC	RHP	PB 0059-3	SL50EC	RHP	PB 0182-3	SP 104 A	KOYO	PB 0091-1
SL 207-22	FYH	PB 0109-1	SL1EDEC	RHP	PB 0059-2	SL50EC	SNR	PB 0182-3	SP 105 A	KOYO	PB 0102-1
SL 207-23	FYH	PB 0123-1	SL2	RHP	PB 0192-1	SL55	RHP	PB 0209-1	SP 106 A	KOYO	PB 0108-1
SL 208	FYH	PB 0138-1	SL2 1/2	RHP	PB 0248-1	SL55	SNR	PB 0209-1	SP 106 MA	KOYO	PB 0114-1
SL 208-24	FYH	PB 0128-1	SL2 1/2DEC	RHP	PB 0248-2	SL55DEC	RHP	PB 0209-2	SP 107 A	KOYO	PB 0122-1

BY PART NUMBER

Part No.	Brand	Group No.	Part No.	Brand	Group No.	Part No.	Brand	Group No.	Part No.	Brand	Group No.
SP 11 M	KOYO	PB 0016-2	SY 1-7/8 FM	SKF	PB 0173-3	SYF 15/16 TM	SKF	PB 0047-1	SYH 2 WM	SKF	PB 0192-2
SP 12 M	KOYO	PB 0026-2	SY 1-7/8 TM	SKF	PB 0173-1	SYF 1-5/8 TM	SKF	PB 0147-1	SYH 2-1/4 TM	SKF	PB 0221-1
SP 16 M	KOYO	PB 0050-2	SY 1-7/8 WM	SKF	PB 0173-2	SYF 1-7/16 TM	SKF	PB 0125-1	SYH 2-1/4 WM	SKF	PB 0221-2
SP 19 M	KOYO	PB 0076-2	SY 1-9/16 FM	SKF	PB 0134-3	SYF 2 TM	SKF	PB 0194-1	SYH 2-3/16 FM	SKF	PB 0216-3
SP 22 M	KOYO	PB 0114-2	SY 1-9/16 TM	SKF	PB 0134-1	SYF 20 TM	SKF	PB 0027-1	SYH 2-3/16 TM	SKF	PB 0216-1
SSP-14	SEALMASTER	PB 0038-2	SY 1-9/16 WM	SKF	PB 0134-2	SYF 2-1/4 TM	SKF	PB 0223-1	SYH 2-3/16 WM	SKF	PB 0216-2
SSP-14E	SEALMASTER	PB 0038-1	SY 2 FM	SKF	PB 0193-3	SYF 2-3/16 TM	SKF	PB 0218-1	SYH 2-7/16 TM	SKF	PB 0243-1
SSP-15	SEALMASTER	PB 0044-2	SY 2 TM	SKF	PB 0193-1	SYF 25 TM	SKF	PB 0053-1	SYH 2-7/16 WM	SKF	PB 0243-2
SSP-15E	SEALMASTER	PB 0044-1	SY 2 WM	SKF	PB 0193-2	SYF 2-7/16 TM	SKF	PB 0245-1	SYH 3/4 FM	SKF	PB 0024-3
SSP-16	SEALMASTER	PB 0058-2	SY 20 FM	SKF	PB 0029-3	SYF 3/4 TM	SKF	PB 0023-1	SYH 3/4 TM	SKF	PB 0024-1
SSP-16E	SEALMASTER	PB 0058-1	SY 20 TM	SKF	PB 0029-1	SYF 30 TM	SKF	PB 0079-1	SYH 3/4 WM	SKF	PB 0024-2
SSP-18	SEALMASTER	PB 0070-2	SY 20 WM	SKF	PB 0029-2	SYF 35 TM	SKF	PB 0117-1	SYH 7/8 FM	SKF	PB 0039-3
SSP-18E	SEALMASTER	PB 0070-1	SY 2-1/2 TM	SKF	PB 0249-1	SYF 40 TM	SKF	PB 0140-1	SYH 7/8 TM	SKF	PB 0039-1
SSP-19	SEALMASTER	PB 0084-2	SY 2-1/4 TM	SKF	PB 0222-1	SYF 45 TM	SKF	PB 0162-1	SYH 7/8 WM	SKF	PB 0039-2
SSP-19E	SEALMASTER	PB 0084-1	SY 2-1/4 WM	SKF	PB 0222-2	SYF 50 TM	SKF	PB 0184-1	SYM 1-1/2 TM	SKF	PB 0131-1
SSP-205	SEALMASTER	PB 0050-2	SY 2-15/16 TM	SKF	PB 0288-1	SYF 55 TM	SKF	PB 0211-1	SYM 1-11/16 TM	SKF	PB 0153-1
SSP-206	SEALMASTER	PB 0076-2	SY 2-3/16 FM	SKF	PB 0217-3	SYF 60 TM	SKF	PB 0233-1	SYM 1-15/16 TM	SKF	PB 0180-1
SSP-20R	SEALMASTER	PB 0090-2	SY 2-3/16 TM	SKF	PB 0217-1	SYF 7/8 TM	SKF	PB 0041-1	SYM 1-3/4 TM	SKF	PB 0158-1
SSP-20RE	SEALMASTER	PB 0090-1	SY 2-3/16 WM	SKF	PB 0217-2	SYH 1 FM	SKF	PB 0059-3	SYM 1-7/16 TM	SKF	PB 0126-1
SY 1 FM	SKF	PB 0060-3	SY 25 FM	SKF	PB 0052-3	SYH 1 TM	SKF	PB 0059-1	SYM 2-1/2 TM	SKF	PB 0251-1
SY 1 TM	SKF	PB 0060-1	SY 25 TM	SKF	PB 0052-1	SYH 1 WM	SKF	PB 0059-2	SYM 2-11/16 TM	SKF	PB 0269-1
SY 1 WM	SKF	PB 0060-2	SY 25 WM	SKF	PB 0052-2	SYH 1-1/16 FM	SKF	PB 0065-3	SYM 2-15/16 TM	SKF	PB 0289-1
SY 1-1/16 FM	SKF	PB 0066-3	SY 2-7/16 TM	SKF	PB 0244-1	SYH 1-1/16 TM	SKF	PB 0065-1	SYM 2-3/16 TM	SKF	PB 0219-1
SY 1-1/16 TM	SKF	PB 0066-1	SY 2-7/16 WM	SKF	PB 0244-2	SYH 1-1/16 WM	SKF	PB 0065-2	SYM 3 TM	SKF	PB 0297-1
SY 1-1/16 WM	SKF	PB 0066-2	SY 3/4 FM	SKF	PB 0025-3	SYH 1-1/2 FM	SKF	PB 0128-3	TB-13	SEALMASTER	PB 0035-1
SY 1-1/2 FM	SKF	PB 0129-3	SY 3/4 TM	SKF	PB 0025-1	SYH 1-1/2 TM	SKF	PB 0128-1	TB-14	SEALMASTER	PB 0041-1
SY 1-1/2 TM	SKF	PB 0129-1	SY 3/4 WM	SKF	PB 0025-2	SYH 1-1/2 WM	SKF	PB 0128-2	TB-15	SEALMASTER	PB 0047-1
SY 1-1/2 WM	SKF	PB 0129-2	SY 30 FM	SKF	PB 0078-3	SYH 1-1/4 AFM	SKF	PB 0092-3	TB-16	SEALMASTER	PB 0061-1
SY 1-1/4 AFM	SKF	PB 0093-3	SY 30 TM	SKF	PB 0078-1	SYH 1-1/4 ATM	SKF	PB 0092-1	TB-17	SEALMASTER	PB 0067-1
SY 1-1/4 ATM	SKF	PB 0093-1	SY 30 WM	SKF	PB 0078-2	SYH 1-1/4 FM	SKF	PB 0095-3	TB-18	SEALMASTER	PB 0073-1
SY 1-1/4 AWM	SKF	PB 0093-2	SY 3-1/2 TM	SKF	PB 0313-1	SYH 1-1/4 FM	SKF	PB 0095-1	TB-19	SEALMASTER	PB 0087-1
SY 1-1/4 FM	SKF	PB 0096-3	SY 35 FM	SKF	PB 0116-3	SYH 1-1/4 WM	SKF	PB 0095-2	TB-20	SEALMASTER	PB 0097-1
SY 1-1/4 TM	SKF	PB 0096-1	SY 35 TM	SKF	PB 0116-1	SYH 1-1/8 FM	SKF	PB 0071-3	TB-205	SEALMASTER	PB 0053-1
SY 1-1/4 WM	SKF	PB 0096-2	SY 35 WM	SKF	PB 0116-2	SYH 1-1/8 TM	SKF	PB 0071-1	TB-206	SEALMASTER	PB 0079-1
SY 1-1/8 FM	SKF	PB 0072-3	SY 40 FM	SKF	PB 0139-3	SYH 1-1/8 WM	SKF	PB 0071-2	TB-207	SEALMASTER	PB 0117-1
SY 1-1/8 TM	SKF	PB 0072-1	SY 40 TM	SKF	PB 0139-1	SYH 1-11/16 FM	SKF	PB 0150-3	TB-208	SEALMASTER	PB 0140-1
SY 1-1/8 WM	SKF	PB 0072-2	SY 40 WM	SKF	PB 0139-2	SYH 1-11/16 TM	SKF	PB 0150-1	TB-209	SEALMASTER	PB 0162-1
SY 1-11/16 FM	SKF	PB 0151-3	SY 45 FM	SKF	PB 0161-3	SYH 1-11/16 WM	SKF	PB 0150-2	TB-20R	SEALMASTER	PB 0094-1
SY 1-11/16 TM	SKF	PB 0151-1	SY 45 TM	SKF	PB 0161-1	SYH 1-15/16 FM	SKF	PB 0177-3	TB-21	SEALMASTER	PB 0105-1
SY 1-11/16 WM	SKF	PB 0151-2	SY 45 WM	SKF	PB 0161-2	SYH 1-15/16 TM	SKF	PB 0177-1	TB-210	SEALMASTER	PB 0184-1
SY 1-15/16 FM	SKF	PB 0178-3	SY 50 FM	SKF	PB 0183-3	SYH 1-15/16 WM	SKF	PB 0177-2	TB-22	SEALMASTER	PB 0111-1
SY 1-15/16 TM	SKF	PB 0178-1	SY 50 TM	SKF	PB 0183-1	SYH 13/16 FM	SKF	PB 0033-3	TB-23	SEALMASTER	PB 0125-1
SY 1-15/16 WM	SKF	PB 0178-2	SY 50 WM	SKF	PB 0183-2	SYH 1-3/16 FM	SKF	PB 0085-3	TB-24	SEALMASTER	PB 0130-1
SY 13/16 FM	SKF	PB 0034-3	SY 55 FM	SKF	PB 0210-3	SYH 13/16 TM	SKF	PB 0033-1	TB-25	SEALMASTER	PB 0135-1
SY 1-3/16 FM	SKF	PB 0086-3	SY 55 TM	SKF	PB 0210-1	SYH 1-3/16 TM	SKF	PB 0085-1	TB-26	SEALMASTER	PB 0147-1
SY 13/16 TM	SKF	PB 0034-1	SY 55 WM	SKF	PB 0210-2	SYH 13/16 WM	SKF	PB 0033-2	TB-27	SEALMASTER	PB 0152-1
SY 1-3/16 TM	SKF	PB 0086-1	SY 60 TM	SKF	PB 0232-1	SYH 1-3/16 WM	SKF	PB 0085-2	TB-28	SEALMASTER	PB 0157-1
SY 13/16 WM	SKF	PB 0034-2	SY 60 WM	SKF	PB 0232-2	SYH 1-3/4 FM	SKF	PB 0155-3	TB-29	SEALMASTER	PB 0169-1
SY 1-3/16 WM	SKF	PB 0086-2	SY 65 TM	SKF	PB 0254-1	SYH 1-3/4 TM	SKF	PB 0155-1	TB-30	SEALMASTER	PB 0174-1
SY 1-3/4 FM	SKF	PB 0156-3	SY 7/8 FM	SKF	PB 0040-3	SYH 1-3/4 WM	SKF	PB 0155-2	TB-31	SEALMASTER	PB 0179-1
SY 1-3/4 TM	SKF	PB 0156-1	SY 7/8 TM	SKF	PB 0040-1	SYH 1-3/8 FM	SKF	PB 0109-3	TB-32R	SEALMASTER	PB 0191-1
SY 1-3/4 WM	SKF	PB 0156-2	SY 7/8 WM	SKF	PB 0040-2	SYH 1-3/8 TM	SKF	PB 0109-1	UBP 204J	NSK	PB 0029-4
SY 1-3/8 FM	SKF	PB 0110-3	SY 70 TM	SKF	PB 0276-1	SYH 1-3/8 WM	SKF	PB 0109-2	UBP 205J	NSK	PB 0052-4
SY 1-3/8 TM	SKF	PB 0110-1	SY 75 TM	SKF	PB 0292-1	SYH 15/16 FM	SKF	PB 0045-3	UBP 206J	NSK	PB 0078-4
SY 1-3/8 WM	SKF	PB 0110-2	SY 80 TM	SKF	PB 0305-1	SYH 1-5/16 FM	SKF	PB 0103-3	UBP 207J	NSK	PB 0116-4
SY 15/16 FM	SKF	PB 0046-3	SY 85 TM	SKF	PB 0311-1	SYH 15/16 TM	SKF	PB 0045-1	UBPP 201	NSK	PB 0001-2
SY 1-5/16 FM	SKF	PB 0104-3	SY 90 TM	SKF	PB 0314-1	SYH 1-5/16 TM	SKF	PB 0103-1	UBPP 202	NSK	PB 0010-2
SY 15/16 TM	SKF	PB 0046-1	SYF 1 TM	SKF	PB 0061-1	SYH 15/16 WM	SKF	PB 0045-2	UBPP 203	NSK	PB 0016-2
SY 1-5/16 TM	SKF	PB 0104-1	SYF 1-1/2 TM	SKF	PB 0130-1	SYH 1-5/16 WM	SKF	PB 0103-2	UBPP 204	NSK	PB 0026-2
SY 15/16 WM	SKF	PB 0046-2	SYF 1-1/4 ATM	SKF	PB 0094-1	SYH 1-5/8 FM	SKF	PB 0145-3	UBPP 205	NSK	PB 0050-2
SY 1-5/16 WM	SKF	PB 0104-2	SYF 1-1/4 TM	SKF	PB 0097-1	SYH 1-5/8 TM	SKF	PB 0145-1	UBPP 206	NSK	PB 0076-2
SY 1-5/8 FM	SKF	PB 0146-3	SYF 1-1/8 TM	SKF	PB 0073-1	SYH 1-5/8 WM	SKF	PB 0145-2	UBPP 207	NSK	PB 0114-2
SY 1-5/8 TM	SKF	PB 0146-1	SYF 1-11/16 TM	SKF	PB 0152-1	SYH 1-7/16 FM	SKF	PB 0123-3	UCAK 204	SLB	PB 0028-1
SY 1-5/8 WM	SKF	PB 0146-2	SYF 1-15/16 TM	SKF	PB 0179-1	SYH 1-7/16 TM	SKF	PB 0123-1	UCAK 204-12	SLB	PB 0024-1
SY 1-7/16 FM	SKF	PB 0124-3	SYF 1-3/16 TM	SKF	PB 0087-1	SYH 1-7/16 WM	SKF	PB 0123-2	UCAK 205	SLB	PB 0051-1
SY 1-7/16 TM	SKF	PB 0124-1	SYF 1-3/4 TM	SKF	PB 0157-1	SYH 2 FM	SKF	PB 0192-3	UCAK 205-13	SLB	PB 0033-1
SY 1-7/16 WM	SKF	PB 0124-2	SYF 1-3/8 TM	SKF	PB 0111-1	SYH 2 TM	SKF	PB 0192-1	UCAK 205-14	SLB	PB 0039-1

BY PART NUMBER

Part No.	Brand	Group No.	Part No.	Brand	Group No.	Part No.	Brand	Group No.	Part No.	Brand	Group No.
UCAK 205-15	SLB	PB 0045-1	UCLP 206-19	ASAHI	PB 0085-1	UCP 202-10	ASAHI	PB 0014-1	UCP 206-18S	NSK	PB 0072-1
UCAK 205-16	SLB	PB 0059-1	UCLP 206-19	NACHI	PB 0085-1	UCP 202-10	FYH	PB 0014-1	UCP 206-19	ASAHI	PB 0086-1
UCAK 206	SLB	PB 0077-1	UCLP 207	ASAHI	PB 0115-1	UCP 202-10	NACHI	PB 0014-1	UCP 206-19	FYH	PB 0086-1
UCAK 206-17	SLB	PB 0065-1	UCLP 207	NACHI	PB 0115-1	UCP 202-10	SLB	PB 0014-1	UCP 206-19	KOYO	PB 0086-1
UCAK 206-18	SLB	PB 0071-1	UCLP 207-20	ASAHI	PB 0095-1	UCP 202-10S	NSK	PB 0014-1	UCP 206-19	NACHI	PB 0086-1
UCAK 206-19	SLB	PB 0085-1	UCLP 207-20	NACHI	PB 0095-1	UCP 202-9	ASAHI	PB 0008-1	UCP 206-19	SLB	PB 0086-1
UCAK 206-20	SLB	PB 0092-1	UCLP 207-21	ASAHI	PB 0103-1	UCP 202-9	NACHI	PB 0008-1	UCP 206-20	SLB	PB 0093-1
UCAK 207	SLB	PB 0115-1	UCLP 207-21	NACHI	PB 0103-1	UCP 202-9	SLB	PB 0008-1	UCP 207	ASAHI	PB 0116-1
UCAK 207-20	SLB	PB 0095-1	UCLP 207-22	ASAHI	PB 0109-1	UCP 203	ASAHI	PB 0017-1	UCP 207	FYH	PB 0116-1
UCAK 207-21	SLB	PB 0103-1	UCLP 207-22	NACHI	PB 0109-1	UCP 203	FYH	PB 0017-1	UCP 207	KOYO	PB 0116-1
UCAK 207-22	SLB	PB 0109-1	UCLP 207-23	ASAHI	PB 0123-1	UCP 203	NACHI	PB 0017-1	UCP 207	NACHI	PB 0116-1
UCAK 207-23	SLB	PB 0123-1	UCLP 207-23	NACHI	PB 0123-1	UCP 203	SLB	PB 0017-1	UCP 207	SLB	PB 0116-1
UCAK 208	SLB	PB 0138-1	UCLP 208	ASAHI	PB 0138-1	UCP 203	NSK	PB 0017-1	UCP 207	NSK	PB 0116-1
UCAK 208-24	SLB	PB 0128-1	UCLP 208	NACHI	PB 0138-1	UCP 203-11	ASAHI	PB 0020-1	UCP 207-20	ASAHI	PB 0096-1
UCAK 208-25	SLB	PB 0133-1	UCLP 208-24	ASAHI	PB 0128-1	UCP 203-11	NACHI	PB 0020-1	UCP 207-20	FYH	PB 0096-1
UCAK 209	SLB	PB 0160-1	UCLP 208-24	NACHI	PB 0128-1	UCP 203-11	SLB	PB 0020-1	UCP 207-20	KOYO	PB 0096-1
UCAK 209-26	SLB	PB 0145-1	UCLP 208-25	ASAHI	PB 0133-1	UCP 204	ASAHI	PB 0029-1	UCP 207-20	NACHI	PB 0096-1
UCAK 209-27	SLB	PB 0150-1	UCLP 208-25	NACHI	PB 0133-1	UCP 204	FYH	PB 0029-1	UCP 207-20	SLB	PB 0096-1
UCAK 209-28	SLB	PB 0155-1	UCLP 209	ASAHI	PB 0160-1	UCP 204	KOYO	PB 0029-1	UCP 207-20S	NSK	PB 0096-1
UCAK 210	SLB	PB 0182-1	UCLP 209	NACHI	PB 0160-1	UCP 204	NACHI	PB 0029-1	UCP 207-21	ASAHI	PB 0104-1
UCAK 210-29	SLB	PB 0167-1	UCLP 209-26	ASAHI	PB 0145-1	UCP 204	SLB	PB 0029-1	UCP 207-21	FYH	PB 0104-1
UCAK 210-30	SLB	PB 0172-1	UCLP 209-26	NACHI	PB 0145-1	UCP 204	NSK	PB 0029-1	UCP 207-21	KOYO	PB 0104-1
UCAK 210-31	SLB	PB 0177-1	UCLP 209-27	ASAHI	PB 0150-1	UCP 204-12	ASAHI	PB 0025-1	UCP 207-21	NACHI	PB 0104-1
UCAK 210-32	SLB	PB 0189-1	UCLP 209-27	NACHI	PB 0150-1	UCP 204-12	FYH	PB 0025-1	UCP 207-21	SLB	PB 0104-1
UCAK 211	SLB	PB 0209-1	UCLP 209-28	ASAHI	PB 0155-1	UCP 204-12	KOYO	PB 0025-1	UCP 207-22	ASAHI	PB 0110-1
UCAK 211-32	SLB	PB 0192-1	UCLP 209-28	NACHI	PB 0155-1	UCP 204-12	NACHI	PB 0025-1	UCP 207-22	FYH	PB 0110-1
UCAK 211-33	SLB	PB 0199-1	UCLP 210	ASAHI	PB 0182-1	UCP 204-12	SLB	PB 0025-1	UCP 207-22	KOYO	PB 0110-1
UCAK 211-34	SLB	PB 0204-1	UCLP 210	NACHI	PB 0182-1	UCP 204-12S	NSK	PB 0025-1	UCP 207-22	NACHI	PB 0110-1
UCAK 211-35	SLB	PB 0216-1	UCLP 210-30	ASAHI	PB 0172-1	UCP 205	ASAHI	PB 0052-1	UCP 207-22	SLB	PB 0110-1
UCAK 212	SLB	PB 0231-1	UCLP 210-30	NACHI	PB 0172-1	UCP 205	FYH	PB 0052-1	UCP 207-22S	NSK	PB 0110-1
UCAK 212-36	SLB	PB 0221-1	UCLP 210-31	ASAHI	PB 0177-1	UCP 205	KOYO	PB 0052-1	UCP 207-23	ASAHI	PB 0124-1
UCAK 212-37	SLB	PB 0226-1	UCLP 210-31	NACHI	PB 0177-1	UCP 205	NACHI	PB 0052-1	UCP 207-23	FYH	PB 0124-1
UCAK 212-38	SLB	PB 0238-1	UCLP 211	ASAHI	PB 0209-1	UCP 205	SLB	PB 0052-1	UCP 207-23	KOYO	PB 0124-1
UCAK 212-39	SLB	PB 0243-1	UCLP 211	NACHI	PB 0209-1	UCP 205	NSK	PB 0052-1	UCP 207-23	NACHI	PB 0124-1
UCAK 213	SLB	PB 0253-1	UCLP 211-32	ASAHI	PB 0192-1	UCP 205-13	KOYO	PB 0034-1	UCP 207-23	SLB	PB 0124-1
UCAK 213-40	SLB	PB 0248-1	UCLP 211-32	NACHI	PB 0192-1	UCP 205-13	SLB	PB 0034-1	UCP 208	ASAHI	PB 0139-1
UCAK 213-41	SLB	PB 0258-1	UCLP 211-34	ASAHI	PB 0204-1	UCP 205-14	ASAHI	PB 0040-1	UCP 208	FYH	PB 0139-1
UCAK 213-41	FYH	PB 0258-1	UCLP 211-34	NACHI	PB 0204-1	UCP 205-14	FYH	PB 0040-1	UCP 208	KOYO	PB 0139-1
UCAK 214	SLB	PB 0275-1	UCLP 211-35	ASAHI	PB 0216-1	UCP 205-14	KOYO	PB 0040-1	UCP 208	NACHI	PB 0139-1
UCAK 214-42	SLB	PB 0263-1	UCLP 211-35	NACHI	PB 0216-1	UCP 205-14	NACHI	PB 0040-1	UCP 208	SLB	PB 0139-1
UCAK 214-42	FYH	PB 0263-1	UCLP 212	ASAHI	PB 0231-1	UCP 205-14	SLB	PB 0040-1	UCP 208	NSK	PB 0139-1
UCAK 214-43	SLB	PB 0267-1	UCLP 212	NACHI	PB 0231-1	UCP 205-14S	NSK	PB 0040-1	UCP 208-24	ASAHI	PB 0129-1
UCAK 214-44	SLB	PB 0271-1	UCLP 212-36	ASAHI	PB 0221-1	UCP 205-15	ASAHI	PB 0046-1	UCP 208-24	FYH	PB 0129-1
UCAK 215	SLB	PB 0291-1	UCLP 212-36	NACHI	PB 0221-1	UCP 205-15	FYH	PB 0046-1	UCP 208-24	KOYO	PB 0129-1
UCAK 215-45	SLB	PB 0279-1	UCLP 212-38	ASAHI	PB 0238-1	UCP 205-15	KOYO	PB 0046-1	UCP 208-24	NACHI	PB 0129-1
UCAK 215-45	FYH	PB 0279-1	UCLP 212-38	NACHI	PB 0238-1	UCP 205-15	NACHI	PB 0046-1	UCP 208-24	SLB	PB 0129-1
UCAK 215-46	SLB	PB 0283-1	UCLP 212-39	ASAHI	PB 0243-1	UCP 205-15	SLB	PB 0046-1	UCP 208-24S	NSK	PB 0129-1
UCAK 215-47	SLB	PB 0287-1	UCLP 212-39	NACHI	PB 0243-1	UCP 205-16	ASAHI	PB 0060-1	UCP 208-25	ASAHI	PB 0134-1
UCAK 215-48	SLB	PB 0295-1	UCLP 213	ASAHI	PB 0253-1	UCP 205-16	FYH	PB 0060-1	UCP 208-25	FYH	PB 0134-1
UCLP 204	ASAHI	PB 0028-1	UCLP 213	NACHI	PB 0253-1	UCP 205-16	KOYO	PB 0060-1	UCP 208-25	KOYO	PB 0134-1
UCLP 204	NACHI	PB 0028-1	UCLP 213-40	ASAHI	PB 0248-1	UCP 205-16	NACHI	PB 0060-1	UCP 208-25	NACHI	PB 0134-1
UCLP 204-12	ASAHI	PB 0024-1	UCLP 213-40	NACHI	PB 0248-1	UCP 205-16	SLB	PB 0060-1	UCP 208-25	SLB	PB 0134-1
UCLP 204-12	NACHI	PB 0024-1	UCP 201	ASAHI	PB 0002-1	UCP 205-16S	NSK	PB 0060-1	UCP 209	ASAHI	PB 0161-1
UCLP 205	ASAHI	PB 0051-1	UCP 201	FYH	PB 0002-1	UCP 206	ASAHI	PB 0078-1	UCP 209	FYH	PB 0161-1
UCLP 205	NACHI	PB 0051-1	UCP 201	NACHI	PB 0002-1	UCP 206	FYH	PB 0078-1	UCP 209	KOYO	PB 0161-1
UCLP 205-14	ASAHI	PB 0039-1	UCP 201	SLB	PB 0002-1	UCP 206	KOYO	PB 0078-1	UCP 209	NACHI	PB 0161-1
UCLP 205-14	NACHI	PB 0039-1	UCP 201	NSK	PB 0002-1	UCP 206	NACHI	PB 0078-1	UCP 209	SLB	PB 0161-1
UCLP 205-15	ASAHI	PB 0045-1	UCP 201-8	ASAHI	PB 0005-1	UCP 206	SLB	PB 0078-1	UCP 209	NSK	PB 0161-1
UCLP 205-15	NACHI	PB 0045-1	UCP 201-8	FYH	PB 0005-1	UCP 206	NSK	PB 0078-1	UCP 209-26	ASAHI	PB 0146-1
UCLP 205-16	ASAHI	PB 0059-1	UCP 201-8	NACHI	PB 0005-1	UCP 206-17	ASAHI	PB 0066-1	UCP 209-26	FYH	PB 0146-1
UCLP 205-16	NACHI	PB 0059-1	UCP 201-8	SLB	PB 0005-1	UCP 206-17	NACHI	PB 0066-1	UCP 209-26	KOYO	PB 0146-1
UCLP 206	ASAHI	PB 0077-1	UCP 201-8S	NSK	PB 0005-1	UCP 206-17	SLB	PB 0066-1	UCP 209-26	NACHI	PB 0146-1
UCLP 206	NACHI	PB 0077-1	UCP 202	ASAHI	PB 0011-1	UCP 206-18	ASAHI	PB 0072-1	UCP 209-26	SLB	PB 0146-1
UCLP 206-17	ASAHI	PB 0065-1	UCP 202	FYH	PB 0011-1	UCP 206-18	FYH	PB 0072-1	UCP 209-26S	NSK	PB 0146-1
UCLP 206-17	NACHI	PB 0065-1	UCP 202	NACHI	PB 0011-1	UCP 206-18	KOYO	PB 0072-1	UCP 209-27	ASAHI	PB 0151-1
UCLP 206-18	ASAHI	PB 0071-1	UCP 202	SLB	PB 0011-1	UCP 206-18	NACHI	PB 0072-1	UCP 209-27	FYH	PB 0151-1
UCLP 206-18	NACHI	PB 0071-1	UCP 202	NSK	PB 0011-1	UCP 206-18	SLB	PB 0072-1	UCP 209-27	KOYO	PB 0151-1

BY PART NUMBER

Part No.	Brand	Group No.	Part No.	Brand	Group No.	Part No.	Brand	Group No.	Part No.	Brand	Group No.
UCP 209-27	NACHI	PB 0151-1	UCP 212-38S	NSK	PB 0239-1	UCP 217-55	SLB	PB 0312-1	UCP 309-28	FYH	PB 0159-1
UCP 209-27	SLB	PB 0151-1	UCP 212-39	ASAHI	PB 0244-1	UCP 218	ASAHI	PB 0314-1	UCP 309-28	SLB	PB 0159-1
UCP 209-28	ASAHI	PB 0156-1	UCP 212-39	FYH	PB 0244-1	UCP 218	FYH	PB 0314-1	UCP 309-28 S	NSK	PB 0159-1
UCP 209-28	FYH	PB 0156-1	UCP 212-39	KOYO	PB 0244-1	UCP 218	NACHI	PB 0314-1	UCP 31 3	ASAHI	PB 0257-1
UCP 209-28	KOYO	PB 0156-1	UCP 212-39	NACHI	PB 0244-1	UCP 218	SLB	PB 0314-1	UCP 31 3-40	ASAHI	PB 0252-1
UCP 209-28	NACHI	PB 0156-1	UCP 212-39	SLB	PB 0244-1	UCP 218	NSK	PB 0314-1	UCP 310	ASAHI	PB 0188-1
UCP 209-28	SLB	PB 0156-1	UCP 213	ASAHI	PB 0254-1	UCP 218-56	ASAHI	PB 0313-1	UCP 310	FYH	PB 0188-1
UCP 209-28S	NSK	PB 0156-1	UCP 213	FYH	PB 0254-1	UCP 218-56	FYH	PB 0313-1	UCP 310	NSK	PB 0188-1
UCP 210	ASAHI	PB 0183-1	UCP 213	KOYO	PB 0254-1	UCP 218-56	NACHI	PB 0313-1	UCP 310	SLB	PB 0188-1
UCP 210	FYH	PB 0183-1	UCP 213	NACHI	PB 0254-1	UCP 218-56	SLB	PB 0313-1	UCP 310-30	ASAHI	PB 0176-1
UCP 210	KOYO	PB 0183-1	UCP 213	SLB	PB 0254-1	UCP 218-56S	NSK	PB 0313-1	UCP 310-29	SLB	PB 0171-1
UCP 210	NACHI	PB 0183-1	UCP 213	NSK	PB 0254-1	UCP 305	ASAHI	PB 0057-1	UCP 310-30	SLB	PB 0176-1
UCP 210	SLB	PB 0183-1	UCP 213-40	ASAHI	PB 0249-1	UCP 305	FYH	PB 0057-1	UCP 310-30 S	NSK	PB 0176-1
UCP 210	NSK	PB 0183-1	UCP 213-40	FYH	PB 0249-1	UCP 305	NSK	PB 0057-1	UCP 310-31	FYH	PB 0181-1
UCP 210-29	SLB	PB 0168-1	UCP 213-40	KOYO	PB 0249-1	UCP 305	SLB	PB 0057-1	UCP 310-31	SLB	PB 0181-1
UCP 210-30	ASAHI	PB 0173-1	UCP 213-40	NACHI	PB 0249-1	UCP 305-13	SLB	PB 0037-1	UCP 310-32	SLB	PB 0197-1
UCP 210-30	FYH	PB 0173-1	UCP 213-40	SLB	PB 0249-1	UCP 305-14	ASAHI	PB 0043-1	UCP 310-32	FYH	PB 0197-1
UCP 210-30	KOYO	PB 0173-1	UCP 213-40S	NSK	PB 0249-1	UCP 305-14	SLB	PB 0043-1	UCP 311	ASAHI	PB 0215-1
UCP 210-30	NACHI	PB 0173-1	UCP 213-41	SLB	PB 0259-1	UCP 305-14 S	NSK	PB 0043-1	UCP 311	FYH	PB 0215-1
UCP 210-30	SLB	PB 0173-1	UCP 214	ASAHI	PB 0276-1	UCP 305-15	SLB	PB 0049-1	UCP 311	NSK	PB 0215-1
UCP 210-30S	NSK	PB 0173-1	UCP 214	FYH	PB 0276-1	UCP 305-16	FYH	PB 0063-1	UCP 311	SLB	PB 0215-1
UCP 210-31	ASAHI	PB 0178-1	UCP 214	NACHI	PB 0276-1	UCP 305-16	SLB	PB 0063-1	UCP 311-32	ASAHI	PB 0198-1
UCP 210-31	FYH	PB 0178-1	UCP 214	SLB	PB 0276-1	UCP 305-16 S	NSK	PB 0063-1	UCP 311-34	ASAHI	PB 0208-1
UCP 210-31	KOYO	PB 0178-1	UCP 214	NSK	PB 0276-1	UCP 306	ASAHI	PB 0083-1	UCP 311-32	FYH	PB 0198-1
UCP 210-31	NACHI	PB 0178-1	UCP 214-42	SLB	PB 0264-1	UCP 306	FYH	PB 0083-1	UCP 311-32	SLB	PB 0198-1
UCP 210-31	SLB	PB 0178-1	UCP 214-43	SLB	PB 0268-1	UCP 306	NSK	PB 0083-1	UCP 311-32 S	NSK	PB 0198-1
UCP 210-32	SLB	PB 0190-1	UCP 214-44	ASAHI	PB 0272-1	UCP 306	SLB	PB 0083-1	UCP 311-33	SLB	PB 0203-1
UCP 211	ASAHI	PB 0210-1	UCP 214-44	FYH	PB 0272-1	UCP 306-17	SLB	PB 0069-1	UCP 311-34	SLB	PB 0208-1
UCP 211	FYH	PB 0210-1	UCP 214-44	NACHI	PB 0272-1	UCP 306-18	ASAHI	PB 0075-1	UCP 311-34 S	NSK	PB 0208-1
UCP 211	KOYO	PB 0210-1	UCP 214-44	SLB	PB 0272-1	UCP 306-18	FYH	PB 0075-1	UCP 311-35	SLB	PB 0220-1
UCP 211	NACHI	PB 0210-1	UCP 214-44S	NSK	PB 0272-1	UCP 306-18	SLB	PB 0075-1	UCP 312	ASAHI	PB 0237-1
UCP 211	SLB	PB 0210-1	UCP 215	ASAHI	PB 0292-1	UCP 306-18 S	NSK	PB 0075-1	UCP 312	FYH	PB 0237-1
UCP 211	NSK	PB 0210-1	UCP 215	FYH	PB 0292-1	UCP 306-19	SLB	PB 0089-1	UCP 312	NSK	PB 0237-1
UCP 211-32	ASAHI	PB 0193-1	UCP 215	NACHI	PB 0292-1	UCP 306-20	SLB	PB 0099-1	UCP 312	SLB	PB 0237-1
UCP 211-32	FYH	PB 0193-1	UCP 215	SLB	PB 0292-1	UCP 306-20	FYH	PB 0099-1	UCP 312-36	ASAHI	PB 0225-1
UCP 211-32	KOYO	PB 0193-1	UCP 215	NSK	PB 0292-1	UCP 307	ASAHI	PB 0121-1	UCP 312-38	ASAHI	PB 0242-1
UCP 211-32	NACHI	PB 0193-1	UCP 215-45	SLB	PB 0280-1	UCP 307	FYH	PB 0121-1	UCP 312-36	SLB	PB 0225-1
UCP 211-32	SLB	PB 0193-1	UCP 215-46	SLB	PB 0284-1	UCP 307	NSK	PB 0121-1	UCP 312-36 S	NSK	PB 0225-1
UCP 211-32S	NSK	PB 0193-1	UCP 215-47	SLB	PB 0288-1	UCP 307	SLB	PB 0121-1	UCP 312-37	SLB	PB 0230-1
UCP 211-33	SLB	PB 0200-1	UCP 215-48	ASAHI	PB 0296-1	UCP 307-20	ASAHI	PB 0101-1	UCP 312-38	SLB	PB 0242-1
UCP 211-34	ASAHI	PB 0205-1	UCP 215-48	FYH	PB 0296-1	UCP 307-20	FYH	PB 0101-1	UCP 312-38 S	NSK	PB 0242-1
UCP 211-34	FYH	PB 0205-1	UCP 215-48	NACHI	PB 0296-1	UCP 307-20	SLB	PB 0101-1	UCP 312-39	SLB	PB 0247-1
UCP 211-34	NACHI	PB 0205-1	UCP 215-48	SLB	PB 0296-1	UCP 307-20 S	NSK	PB 0101-1	UCP 313	FYH	PB 0257-1
UCP 211-34S	NSK	PB 0205-1	UCP 215-48S	NSK	PB 0296-1	UCP 307-21	SLB	PB 0107-1	UCP 313	NSK	PB 0257-1
UCP 211-35	ASAHI	PB 0217-1	UCP 216	ASAHI	PB 0305-1	UCP 307-22	ASAHI	PB 0113-1	UCP 313	SLB	PB 0257-1
UCP 211-35	FYH	PB 0217-1	UCP 216	FYH	PB 0305-1	UCP 307-22	FYH	PB 0113-1	UCP 313-40	FYH	PB 0252-1
UCP 211-35	KOYO	PB 0217-1	UCP 216	NACHI	PB 0305-1	UCP 307-22	SLB	PB 0113-1	UCP 313-40	SLB	PB 0252-1
UCP 211-35	NACHI	PB 0217-1	UCP 216	SLB	PB 0305-1	UCP 307-23	FYH	PB 0127-1	UCP 313-40 S	NSK	PB 0252-1
UCP 211-35	SLB	PB 0217-1	UCP 216-49	SLB	PB 0299-1	UCP 307-23	SLB	PB 0127-1	UCP 313-41	SLB	PB 0262-1
UCP 212	ASAHI	PB 0232-1	UCP 216-50	ASAHI	PB 0302-1	UCP 308	ASAHI	PB 0144-1	UCP 314	ASAHI	PB 0278-1
UCP 212	FYH	PB 0232-1	UCP 216-50	FYH	PB 0302-1	UCP 308	FYH	PB 0144-1	UCP 314	FYH	PB 0278-1
UCP 212	KOYO	PB 0232-1	UCP 216-50	NACHI	PB 0302-1	UCP 308	NSK	PB 0144-1	UCP 314	NSK	PB 0278-1
UCP 212	NACHI	PB 0232-1	UCP 216-50	SLB	PB 0302-1	UCP 308	SLB	PB 0144-1	UCP 314	SLB	PB 0278-1
UCP 212	SLB	PB 0232-1	UCP 216-50S	NSK	PB 0302-1	UCP 308-24	ASAHI	PB 0132-1	UCP 314-42	SLB	PB 0266-1
UCP 212	NSK	PB 0232-1	UCP 216-51	SLB	PB 0308-1	UCP 308-24	FYH	PB 0132-1	UCP 314-43	SLB	PB 0270-1
UCP 212-36	ASAHI	PB 0222-1	UCP 217	ASAHI	PB 0311-1	UCP 308-24	SLB	PB 0132-1	UCP 314-44	ASAHI	PB 0274-1
UCP 212-36	FYH	PB 0222-1	UCP 217	FYH	PB 0311-1	UCP 308-24 S	NSK	PB 0132-1	UCP 314-44	FYH	PB 0274-1
UCP 212-36	KOYO	PB 0222-1	UCP 217	NACHI	PB 0311-1	UCP 308-25	SLB	PB 0137-1	UCP 314-44	SLB	PB 0274-1
UCP 212-36	NACHI	PB 0222-1	UCP 217	SLB	PB 0311-1	UCP 309	ASAHI	PB 0166-1	UCP 314-44 S	NSK	PB 0274-1
UCP 212-36	SLB	PB 0222-1	UCP 217	NSK	PB 0311-1	UCP 309	FYH	PB 0166-1	UCP 315	ASAHI	PB 0294-1
UCP 212-36S	NSK	PB 0222-1	UCP 217-52	ASAHI	PB 0309-1	UCP 309	NSK	PB 0166-1	UCP 315	FYH	PB 0294-1
UCP 212-37	SLB	PB 0227-1	UCP 217-52	FYH	PB 0309-1	UCP 309	SLB	PB 0166-1	UCP 315	NSK	PB 0294-1
UCP 212-38	ASAHI	PB 0239-1	UCP 217-52	NACHI	PB 0309-1	UCP 309-26	ASAHI	PB 0149-1	UCP 315	SLB	PB 0294-1
UCP 212-38	FYH	PB 0239-1	UCP 217-52	SLB	PB 0309-1	UCP 309-26	SLB	PB 0149-1	UCP 315-45	SLB	PB 0282-1
UCP 212-38	NACHI	PB 0239-1	UCP 217-52S	NSK	PB 0309-1	UCP 309-26 S	NSK	PB 0149-1	UCP 315-46	SLB	PB 0286-1
UCP 212-38	SLB	PB 0239-1	UCP 217-53	SLB	PB 0310-1	UCP 309-27	SLB	PB 0154-1	UCP 315-47	SLB	PB 0290-1
						UCP 309-28	ASAHI	PB 0159-1	UCP 315-48	ASAHI	PB 0298-1

BY PART NUMBER

Part No.	Brand	Group No.	Part No.	Brand	Group No.	Part No.	Brand	Group No.	Part No.	Brand	Group No.
UCP 315-48	FYH	PB 0298-1	UCP X09-28	FYH	PB 0158-1	UCP X15-47	ASAHI	PB 0289-1	UCP214D1	NTN	PB 0276-1
UCP 315-48	SLB	PB 0298-1	UCP X09-28	SLB	PB 0158-1	UCP X15-47	SLB	PB 0289-1	UCP215-213D1	NTN	PB 0280-1
UCP 315-48 S	NSK	PB 0298-1	UCP X1 3	ASAHI	PB 0256-1	UCP X15-48	ASAHI	PB 0297-1	UCP215-214D1	NTN	PB 0284-1
UCP 316	ASAHI	PB 0307-1	UCP X1 3-40	ASAHI	PB 0251-1	UCP X15-48	FYH	PB 0297-1	UCP215-215D1	NTN	PB 0288-1
UCP 316	FYH	PB 0307-1	UCP X10	ASAHI	PB 0187-1	UCP X15-48	SLB	PB 0297-1	UCP215-300D1	NTN	PB 0296-1
UCP 316	NSK	PB 0307-1	UCP X10	FYH	PB 0187-1	UCP X16	ASAHI	PB 0306-1	UCP215D1	NTN	PB 0292-1
UCP 316	SLB	PB 0307-1	UCP X10	NSK	PB 0187-1	UCP X16	FYH	PB 0306-1	UCP216-301D1	NTN	PB 0299-1
UCP 316-49	SLB	PB 0301-1	UCP X10	SLB	PB 0187-1	UCP X16	NSK	PB 0306-1	UCP216-302D1	NTN	PB 0302-1
UCP 316-50	ASAHI	PB 0304-1	UCP X10-30	ASAHI	PB 0175-1	UCP X16	SLB	PB 0306-1	UCP216-303D1	NTN	PB 0308-1
UCP 316-50	SLB	PB 0304-1	UCP X10-31	ASAHI	PB 0180-1	UCP X16-49	SLB	PB 0300-1	UCP216D1	NTN	PB 0305-1
UCP 316-50 S	NSK	PB 0304-1	UCP X10-32	ASAHI	PB 0195-1	UCP X16-50	ASAHI	PB 0303-1	UCP217-304D1	NTN	PB 0309-1
UCP X05	ASAHI	PB 0056-1	UCP X10-29	SLB	PB 0170-1	UCP X16-50	SLB	PB 0303-1	UCP217-305D1	NTN	PB 0310-1
UCP X05	FYH	PB 0056-1	UCP X10-29	FYH	PB 0170-1	UCP201-008D1	NTN	PB 0005-1	UCP217-307D1	NTN	PB 0312-1
UCP X05	NSK	PB 0056-1	UCP X10-30	SLB	PB 0175-1	UCP201D1	NTN	PB 0002-1	UCP217D1	NTN	PB 0311-1
UCP X05	SLB	PB 0056-1	UCP X10-31	FYH	PB 0180-1	UCP202-009D1	NTN	PB 0008-1	UCP218-308D1	NTN	PB 0313-1
UCP X05-13	SLB	PB 0036-1	UCP X10-31	SLB	PB 0180-1	UCP202-010D1	NTN	PB 0014-1	UCP218D1	NTN	PB 0314-1
UCP X05-14	ASAHI	PB 0042-1	UCP X10-32	FYH	PB 0195-1	UCP202D1	NTN	PB 0011-1	UCP305-013D1	NTN	PB 0037-1
UCP X05-14	SLB	PB 0042-1	UCP X10-32	SLB	PB 0195-1	UCP203-011D1	NTN	PB 0020-1	UCP305-014D1	NTN	PB 0043-1
UCP X05-15	ASAHI	PB 0048-1	UCP X11	ASAHI	PB 0212-1	UCP203D1	NTN	PB 0017-1	UCP305-015D1	NTN	PB 0049-1
UCP X05-15	SLB	PB 0048-1	UCP X11	FYH	PB 0212-1	UCP204-012D1	NTN	PB 0025-1	UCP305-100D1	NTN	PB 0063-1
UCP X05-16	ASAHI	PB 0062-1	UCP X11	NSK	PB 0212-1	UCP204D1	NTN	PB 0029-1	UCP305D1	NTN	PB 0057-1
UCP X05-16	FYH	PB 0062-1	UCP X11	SLB	PB 0212-1	UCP205-013D1	NTN	PB 0034-1	UCP306-101D1	NTN	PB 0069-1
UCP X05-16	SLB	PB 0062-1	UCP X11-34	ASAHI	PB 0207-1	UCP205-014D1	NTN	PB 0040-1	UCP306-102D1	NTN	PB 0075-1
UCP X06	ASAHI	PB 0082-1	UCP X11-35	ASAHI	PB 0219-1	UCP205-015D1	NTN	PB 0046-1	UCP306-103D1	NTN	PB 0089-1
UCP X06	FYH	PB 0082-1	UCP X11-32	SLB	PB 0196-1	UCP205-100D1	NTN	PB 0060-1	UCP306D1	NTN	PB 0083-1
UCP X06	NSK	PB 0082-1	UCP X11-32	FYH	PB 0196-1	UCP205D1	NTN	PB 0052-1	UCP307-104D1	NTN	PB 0101-1
UCP X06	SLB	PB 0082-1	UCP X11-33	SLB	PB 0202-1	UCP206-101D1	NTN	PB 0066-1	UCP307-105D1	NTN	PB 0107-1
UCP X06-17	SLB	PB 0068-1	UCP X11-34	SLB	PB 0207-1	UCP206-102D1	NTN	PB 0072-1	UCP307-106D1	NTN	PB 0113-1
UCP X06-18	ASAHI	PB 0074-1	UCP X11-35	FYH	PB 0219-1	UCP206-103D1	NTN	PB 0086-1	UCP307-107D1	NTN	PB 0127-1
UCP X06-18	SLB	PB 0074-1	UCP X11-35	SLB	PB 0219-1	UCP206-104D1	NTN	PB 0093-1	UCP307D1	NTN	PB 0121-1
UCP X06-19	ASAHI	PB 0088-1	UCP X12	ASAHI	PB 0236-1	UCP206D1	NTN	PB 0078-1	UCP308-108D1	NTN	PB 0132-1
UCP X06-19	FYH	PB 0088-1	UCP X12	FYH	PB 0236-1	UCP207-104D1	NTN	PB 0096-1	UCP308-109D1	NTN	PB 0137-1
UCP X06-19	SLB	PB 0088-1	UCP X12	NSK	PB 0236-1	UCP207-105D1	NTN	PB 0104-1	UCP308D1	NTN	PB 0144-1
UCP X06-20	ASAHI	PB 0098-1	UCP X12	SLB	PB 0236-1	UCP207-106D1	NTN	PB 0110-1	UCP309-110D1	NTN	PB 0149-1
UCP X06-20	FYH	PB 0098-1	UCP X12-36	ASAHI	PB 0224-1	UCP207-107D1	NTN	PB 0124-1	UCP309-111D1	NTN	PB 0154-1
UCP X06-20	SLB	PB 0098-1	UCP X12-38	ASAHI	PB 0241-1	UCP207D1	NTN	PB 0116-1	UCP309-112D1	NTN	PB 0159-1
UCP X07	ASAHI	PB 0120-1	UCP X12-39	ASAHI	PB 0246-1	UCP208-108D1	NTN	PB 0128-1	UCP309D1	NTN	PB 0166-1
UCP X07	FYH	PB 0120-1	UCP X12-36	FYH	PB 0224-1	UCP208-108D1	NTN	PB 0129-1	UCP310-113D1	NTN	PB 0171-1
UCP X07	NSK	PB 0120-1	UCP X12-36	SLB	PB 0224-1	UCP208-109D1	NTN	PB 0133-1	UCP310-114D1	NTN	PB 0176-1
UCP X07	SLB	PB 0120-1	UCP X12-37	SLB	PB 0229-1	UCP208-109D1	NTN	PB 0134-1	UCP310-115D1	NTN	PB 0181-1
UCP X07-2 3	ASAHI	PB 0126-1	UCP X12-37	FYH	PB 0229-1	UCP208D1	NTN	PB 0138-1	UCP310D1	NTN	PB 0188-1
UCP X07-20	SLB	PB 0100-1	UCP X12-38	FYH	PB 0241-1	UCP208D1	NTN	PB 0139-1	UCP311-200D1	NTN	PB 0198-1
UCP X07-20	FYH	PB 0100-1	UCP X12-38	SLB	PB 0241-1	UCP209-110D1	NTN	PB 0146-1	UCP311-201D1	NTN	PB 0203-1
UCP X07-21	SLB	PB 0106-1	UCP X12-39	FYH	PB 0246-1	UCP209-111D1	NTN	PB 0151-1	UCP311-202D1	NTN	PB 0208-1
UCP X07-22	ASAHI	PB 0112-1	UCP X12-39	SLB	PB 0246-1	UCP209-112D1	NTN	PB 0156-1	UCP311-203D1	NTN	PB 0220-1
UCP X07-22	FYH	PB 0112-1	UCP X13	FYH	PB 0256-1	UCP209D1	NTN	PB 0161-1	UCP311D1	NTN	PB 0215-1
UCP X07-22	SLB	PB 0112-1	UCP X13	NSK	PB 0256-1	UCP210-113D1	NTN	PB 0168-1	UCP312-204D1	NTN	PB 0225-1
UCP X07-23	FYH	PB 0126-1	UCP X13	SLB	PB 0256-1	UCP210-114D1	NTN	PB 0173-1	UCP312-205D1	NTN	PB 0230-1
UCP X07-23	SLB	PB 0126-1	UCP X13-40	FYH	PB 0251-1	UCP210-115D1	NTN	PB 0178-1	UCP312-206D1	NTN	PB 0242-1
UCP X08	ASAHI	PB 0143-1	UCP X13-40	SLB	PB 0251-1	UCP210-200D1	NTN	PB 0190-1	UCP312-207D1	NTN	PB 0247-1
UCP X08	FYH	PB 0143-1	UCP X13-41	SLB	PB 0261-1	UCP210D1	NTN	PB 0183-1	UCP312D1	NTN	PB 0237-1
UCP X08	NSK	PB 0143-1	UCP X14	ASAHI	PB 0277-1	UCP211-200D1	NTN	PB 0193-1	UCP313-208D1	NTN	PB 0252-1
UCP X08	SLB	PB 0143-1	UCP X14	FYH	PB 0277-1	UCP211-201D1	NTN	PB 0200-1	UCP313-209D1	NTN	PB 0262-1
UCP X08-24	ASAHI	PB 0131-1	UCP X14	NSK	PB 0277-1	UCP211-202D1	NTN	PB 0205-1	UCP313D1	NTN	PB 0257-1
UCP X08-24	FYH	PB 0131-1	UCP X14	SLB	PB 0277-1	UCP211-203D1	NTN	PB 0217-1	UCP314-210D1	NTN	PB 0266-1
UCP X08-24	SLB	PB 0131-1	UCP X14-4 3	ASAHI	PB 0269-1	UCP211D1	NTN	PB 0210-1	UCP314-211D1	NTN	PB 0270-1
UCP X08-25	SLB	PB 0136-1	UCP X14-42	SLB	PB 0265-1	UCP212-204D1	NTN	PB 0222-1	UCP314-212D1	NTN	PB 0274-1
UCP X09	ASAHI	PB 0165-1	UCP X14-43	SLB	PB 0269-1	UCP212-205D1	NTN	PB 0227-1	UCP314D1	NTN	PB 0278-1
UCP X09	FYH	PB 0165-1	UCP X14-44	ASAHI	PB 0273-1	UCP212-206D1	NTN	PB 0239-1	UCP315-213D1	NTN	PB 0282-1
UCP X09	NSK	PB 0165-1	UCP X14-44	FYH	PB 0273-1	UCP212-207D1	NTN	PB 0244-1	UCP315-214D1	NTN	PB 0286-1
UCP X09	SLB	PB 0165-1	UCP X14-44	SLB	PB 0273-1	UCP212D1	NTN	PB 0232-1	UCP315-215D1	NTN	PB 0290-1
UCP X09-26	ASAHI	PB 0148-1	UCP X15	ASAHI	PB 0293-1	UCP213-208D1	NTN	PB 0249-1	UCP315-300D1	NTN	PB 0298-1
UCP X09-26	SLB	PB 0148-1	UCP X15	FYH	PB 0293-1	UCP213-209D1	NTN	PB 0259-1	UCP315D1	NTN	PB 0294-1
UCP X09-27	ASAHI	PB 0153-1	UCP X15	NSK	PB 0293-1	UCP213D1	NTN	PB 0254-1	UCP316-301D1	NTN	PB 0301-1
UCP X09-27	FYH	PB 0153-1	UCP X15	SLB	PB 0293-1	UCP214-210D1	NTN	PB 0264-1	UCP316-302D1	NTN	PB 0304-1
UCP X09-27	SLB	PB 0153-1	UCP X15-45	SLB	PB 0281-1	UCP214-211D1	NTN	PB 0268-1	UCP316D1	NTN	PB 0307-1
UCP X09-28	ASAHI	PB 0158-1	UCP X15-46	SLB	PB 0285-1	UCP214-212D1	NTN	PB 0272-1	UCPA 201	ASAHI	PB 0003-1

BY PART NUMBER

Part No.	Brand	Group No.	Part No.	Brand	Group No.	Part No.	Brand	Group No.	Part No.	Brand	Group No.
UCPA 201	FYH	PB 0003-1	UCPA 206-17	SLB	PB 0067-1	UCPA 210	ASAHI	PB 0184-1	UCPL212-206D1	NTN	PB 0238-1
UCPA 201	NACHI	PB 0003-1	UCPA 206-18	ASAHI	PB 0073-1	UCPA 210	FYH	PB 0184-1	UCPL212-207D1	NTN	PB 0243-1
UCPA 201	SLB	PB 0003-1	UCPA 206-18	FYH	PB 0073-1	UCPA 210	NACHI	PB 0184-1	UCPL212D1	NTN	PB 0231-1
UCPA 201	NSK	PB 0003-1	UCPA 206-18	NACHI	PB 0073-1	UCPA 210	SLB	PB 0184-1	UCPX05-013D1	NTN	PB 0036-1
UCPA 201-8	ASAHI	PB 0006-1	UCPA 206-18	SLB	PB 0073-1	UCPA 210	NSK	PB 0184-1	UCPX05-014D1	NTN	PB 0042-1
UCPA 201-8	FYH	PB 0006-1	UCPA 206-18S	NSK	PB 0073-1	UCPA 210-29	SLB	PB 0169-1	UCPX05-015D1	NTN	PB 0048-1
UCPA 201-8	NACHI	PB 0006-1	UCPA 206-19	ASAHI	PB 0087-1	UCPA 210-30	ASAHI	PB 0174-1	UCPX05-100D1	NTN	PB 0062-1
UCPA 201-8	SLB	PB 0006-1	UCPA 206-19	FYH	PB 0087-1	UCPA 210-30	FYH	PB 0174-1	UCPX05D1	NTN	PB 0056-1
UCPA 201-8S	NSK	PB 0006-1	UCPA 206-19	NACHI	PB 0087-1	UCPA 210-30	NACHI	PB 0174-1	UCPX06-101D1	NTN	PB 0068-1
UCPA 202	ASAHI	PB 0012-1	UCPA 206-19	SLB	PB 0087-1	UCPA 210-30	SLB	PB 0174-1	UCPX06-102D1	NTN	PB 0074-1
UCPA 202	FYH	PB 0012-1	UCPA 206-20	SLB	PB 0094-1	UCPA 210-30S	NSK	PB 0174-1	UCPX06-103D1	NTN	PB 0088-1
UCPA 202	NACHI	PB 0012-1	UCPA 207	ASAHI	PB 0117-1	UCPA 210-31	ASAHI	PB 0179-1	UCPX06-104D1	NTN	PB 0098-1
UCPA 202	SLB	PB 0012-1	UCPA 207	FYH	PB 0117-1	UCPA 210-31	FYH	PB 0179-1	UCPX06D1	NTN	PB 0082-1
UCPA 202	NSK	PB 0012-1	UCPA 207	NACHI	PB 0117-1	UCPA 210-31	NACHI	PB 0179-1	UCPX07-105D1	NTN	PB 0106-1
UCPA 202-10	ASAHI	PB 0015-1	UCPA 207	SLB	PB 0117-1	UCPA 210-31	SLB	PB 0179-1	UCPX07-106D1	NTN	PB 0112-1
UCPA 202-10	FYH	PB 0015-1	UCPA 207	NSK	PB 0117-1	UCPA 210-32	SLB	PB 0191-1	UCPX07-107D1	NTN	PB 0126-1
UCPA 202-10	NACHI	PB 0015-1	UCPA 207-20	ASAHI	PB 0097-1	UCPA 211	SLB	PB 0211-1	UCPX07D1	NTN	PB 0120-1
UCPA 202-10	SLB	PB 0015-1	UCPA 207-20	FYH	PB 0097-1	UCPA 211-32	SLB	PB 0194-1	UCPX08-108D1	NTN	PB 0131-1
UCPA 202-10S	NSK	PB 0015-1	UCPA 207-20	NACHI	PB 0097-1	UCPA 211-33	SLB	PB 0201-1	UCPX08-109D1	NTN	PB 0136-1
UCPA 202-9	ASAHI	PB 0009-1	UCPA 207-20	SLB	PB 0097-1	UCPA 211-33	FYH	PB 0201-1	UCPX08D1	NTN	PB 0143-1
UCPA 202-9	NACHI	PB 0009-1	UCPA 207-20S	NSK	PB 0097-1	UCPA 211-34	SLB	PB 0206-1	UCPX09-110D1	NTN	PB 0148-1
UCPA 202-9	SLB	PB 0009-1	UCPA 207-21	ASAHI	PB 0105-1	UCPA 211-35	SLB	PB 0218-1	UCPX09-111D1	NTN	PB 0153-1
UCPA 203	ASAHI	PB 0018-1	UCPA 207-21	FYH	PB 0105-1	UCPA 212	SLB	PB 0233-1	UCPX09-112D1	NTN	PB 0158-1
UCPA 203	FYH	PB 0018-1	UCPA 207-21	NACHI	PB 0105-1	UCPA 212-36	SLB	PB 0223-1	UCPX09D1	NTN	PB 0165-1
UCPA 203	NACHI	PB 0018-1	UCPA 207-21	SLB	PB 0105-1	UCPA 212-37	SLB	PB 0228-1	UCPX10-114D1	NTN	PB 0175-1
UCPA 203	SLB	PB 0018-1	UCPA 207-22	ASAHI	PB 0111-1	UCPA 212-37	FYH	PB 0228-1	UCPX10-115D1	NTN	PB 0180-1
UCPA 203	NSK	PB 0018-1	UCPA 207-22	FYH	PB 0111-1	UCPA 212-38	SLB	PB 0240-1	UCPX10-200D1	NTN	PB 0195-1
UCPA 203-11	ASAHI	PB 0021-1	UCPA 207-22	NACHI	PB 0111-1	UCPA 212-39	SLB	PB 0245-1	UCPX10D1	NTN	PB 0187-1
UCPA 203-11	NACHI	PB 0021-1	UCPA 207-22	SLB	PB 0111-1	UCPA 213	SLB	PB 0255-1	UCPX11-201D1	NTN	PB 0202-1
UCPA 203-11	SLB	PB 0021-1	UCPA 207-22S	NSK	PB 0111-1	UCPA 213	FYH	PB 0255-1	UCPX11-202D1	NTN	PB 0207-1
UCPA 204	ASAHI	PB 0027-1	UCPA 207-23	ASAHI	PB 0125-1	UCPA 213-40	SLB	PB 0250-1	UCPX11-203D1	NTN	PB 0219-1
UCPA 204	FYH	PB 0027-1	UCPA 207-23	FYH	PB 0125-1	UCPA 213-40	FYH	PB 0250-1	UCPX11D1	NTN	PB 0212-1
UCPA 204	NACHI	PB 0027-1	UCPA 207-23	NACHI	PB 0125-1	UCPA 213-41	SLB	PB 0260-1	UCPX12-206D1	NTN	PB 0241-1
UCPA 204	SLB	PB 0027-1	UCPA 207-23	SLB	PB 0125-1	UCPA 213-41	FYH	PB 0260-1	UCPX12-207D1	NTN	PB 0246-1
UCPA 204	NSK	PB 0027-1	UCPA 208	ASAHI	PB 0140-1	UCPL204-012D1	NTN	PB 0024-1	UCPX12D1	NTN	PB 0236-1
UCPA 204-12	ASAHI	PB 0023-1	UCPA 208	FYH	PB 0140-1	UCPL204D1	NTN	PB 0028-1	UCPX13-208D1	NTN	PB 0251-1
UCPA 204-12	FYH	PB 0023-1	UCPA 208	NACHI	PB 0140-1	UCPL205-013D1	NTN	PB 0033-1	UCPX13-209D1	NTN	PB 0261-1
UCPA 204-12	NACHI	PB 0023-1	UCPA 208	SLB	PB 0140-1	UCPL205-014D1	NTN	PB 0039-1	UCPX13D1	NTN	PB 0256-1
UCPA 204-12	SLB	PB 0023-1	UCPA 208	NSK	PB 0140-1	UCPL205-015D1	NTN	PB 0045-1	UCPX14-210D1	NTN	PB 0265-1
UCPA 204-12S	NSK	PB 0023-1	UCPA 208-24	ASAHI	PB 0130-1	UCPL205-100D1	NTN	PB 0059-1	UCPX14-211D1	NTN	PB 0269-1
UCPA 205	ASAHI	PB 0053-1	UCPA 208-24	FYH	PB 0130-1	UCPL205D1	NTN	PB 0051-1	UCPX14-212D1	NTN	PB 0273-1
UCPA 205	FYH	PB 0053-1	UCPA 208-24	NACHI	PB 0130-1	UCPL206-101D1	NTN	PB 0065-1	UCPX14D1	NTN	PB 0271-1
UCPA 205	NACHI	PB 0053-1	UCPA 208-24	SLB	PB 0130-1	UCPL206-102D1	NTN	PB 0071-1	UCPX15-213D1	NTN	PB 0281-1
UCPA 205	SLB	PB 0053-1	UCPA 208-24S	NSK	PB 0130-1	UCPL206-103D1	NTN	PB 0085-1	UCPX15-214D1	NTN	PB 0285-1
UCPA 205	NSK	PB 0053-1	UCPA 208-25	ASAHI	PB 0135-1	UCPL206-104D1	NTN	PB 0092-1	UCPX15-215D1	NTN	PB 0289-1
UCPA 205-13	SLB	PB 0035-1	UCPA 208-25	FYH	PB 0135-1	UCPL206D1	NTN	PB 0077-1	UCPX15-300D1	NTN	PB 0297-1
UCPA 205-14	ASAHI	PB 0041-1	UCPA 208-25	NACHI	PB 0135-1	UCPL207-104D1	NTN	PB 0095-1	UCPX15D1	NTN	PB 0293-1
UCPA 205-14	FYH	PB 0041-1	UCPA 208-25	SLB	PB 0135-1	UCPL207-105D1	NTN	PB 0103-1	UCPX16-301D1	NTN	PB 0300-1
UCPA 205-14	NACHI	PB 0041-1	UCPA 209	ASAHI	PB 0162-1	UCPL207-106D1	NTN	PB 0109-1	UCPX16-302D1	NTN	PB 0303-1
UCPA 205-14	SLB	PB 0041-1	UCPA 209	FYH	PB 0162-1	UCPL207-107D1	NTN	PB 0123-1	UCPX16D1	NTN	PB 0306-1
UCPA 205-14S	NSK	PB 0041-1	UCPA 209	NACHI	PB 0162-1	UCPL207D1	NTN	PB 0115-1	UCUP201-008D1	NTN	PB 0006-1
UCPA 205-15	ASAHI	PB 0047-1	UCPA 209	SLB	PB 0162-1	UCPL209-110D1	NTN	PB 0145-1	UCUP201D1	NTN	PB 0003-1
UCPA 205-15	FYH	PB 0047-1	UCPA 209	NSK	PB 0162-1	UCPL209-111D1	NTN	PB 0150-1	UCUP202-009D1	NTN	PB 0009-1
UCPA 205-15	NACHI	PB 0047-1	UCPA 209-26	ASAHI	PB 0147-1	UCPL209-112D1	NTN	PB 0155-1	UCUP202-010D1	NTN	PB 0015-1
UCPA 205-15	SLB	PB 0047-1	UCPA 209-26	FYH	PB 0147-1	UCPL209D1	NTN	PB 0160-1	UCUP202D1	NTN	PB 0012-1
UCPA 205-16	ASAHI	PB 0061-1	UCPA 209-26	NACHI	PB 0147-1	UCPL210-113D1	NTN	PB 0167-1	UCUP203-011D1	NTN	PB 0021-1
UCPA 205-16	FYH	PB 0061-1	UCPA 209-26	SLB	PB 0147-1	UCPL210-114D1	NTN	PB 0172-1	UCUP203D1	NTN	PB 0018-1
UCPA 205-16	NACHI	PB 0061-1	UCPA 209-26S	NSK	PB 0147-1	UCPL210-115D1	NTN	PB 0177-1	UCUP204-012D1	NTN	PB 0023-1
UCPA 205-16	SLB	PB 0061-1	UCPA 209-27	ASAHI	PB 0152-1	UCPL210-200D1	NTN	PB 0189-1	UCUP204D1	NTN	PB 0027-1
UCPA 205-16S	NSK	PB 0061-1	UCPA 209-27	FYH	PB 0152-1	UCPL210D1	NTN	PB 0182-1	UCUP205-013D1	NTN	PB 0035-1
UCPA 206	ASAHI	PB 0079-1	UCPA 209-27	NACHI	PB 0152-1	UCPL211-200D1	NTN	PB 0192-1	UCUP205-014D1	NTN	PB 0041-1
UCPA 206	FYH	PB 0079-1	UCPA 209-27	SLB	PB 0152-1	UCPL211-201D1	NTN	PB 0199-1	UCUP205-015D1	NTN	PB 0047-1
UCPA 206	NACHI	PB 0079-1	UCPA 209-28	ASAHI	PB 0157-1	UCPL211-202D1	NTN	PB 0204-1	UCUP205-100D1	NTN	PB 0061-1
UCPA 206	SLB	PB 0079-1	UCPA 209-28	FYH	PB 0157-1	UCPL211-203D1	NTN	PB 0216-1	UCUP205D1	NTN	PB 0053-1
UCPA 206	NSK	PB 0079-1	UCPA 209-28	NACHI	PB 0157-1	UCPL211D1	NTN	PB 0209-1	UCUP206-101D1	NTN	PB 0067-1
UCPA 206-17	ASAHI	PB 0067-1	UCPA 209-28	SLB	PB 0157-1	UCPL212-204D1	NTN	PB 0221-1	UCUP206-102D1	NTN	PB 0073-1
UCPA 206-17	NACHI	PB 0067-1	UCPA 209-28S	NSK	PB 0157-1	UCPL212-205D1	NTN	PB 0226-1	UCUP206-103D1	NTN	PB 0087-1

BY PART NUMBER

Part No.	Brand	Group No.	Part No.	Brand	Group No.	Part No.	Brand	Group No.	Part No.	Brand	Group No.
UCUP206-104D1	NTN	PB 0094-1	UELP 201-8	SLB	PB 0005-2	UELP206D1W3	NTN	PB 0078-2	UELPL210-200D1W3	NTN	PB 0189-2
UCUP206D1	NTN	PB 0079-1	UELP 202	SLB	PB 0011-2	UELP207-104D1W3	NTN	PB 0096-2	UELPL210D1W3	NTN	PB 0182-2
UCUP207-104D1	NTN	PB 0097-1	UELP 202-10	SLB	PB 0014-2	UELP207-105D1W3	NTN	PB 0104-2	UELPL211-200D1W3	NTN	PB 0192-2
UCUP207-105D1	NTN	PB 0105-1	UELP 203	SLB	PB 0017-2	UELP207-106D1W3	NTN	PB 0110-2	UELPL211-201D1W3	NTN	PB 0199-2
UCUP207-106D1	NTN	PB 0111-1	UELP 203-11	SLB	PB 0020-2	UELP207-107D1W3	NTN	PB 0124-2	UELPL211-202D1W3	NTN	PB 0204-2
UCUP207-107D1	NTN	PB 0125-1	UELP 204	SLB	PB 0029-2	UELP207D1W3	NTN	PB 0116-2	UELPL211-203D1W3	NTN	PB 0216-2
UCUP207D1	NTN	PB 0117-1	UELP 204-12	SLB	PB 0025-2	UELP208-108D1W3	NTN	PB 0128-2	UELPL211D1W3	NTN	PB 0209-2
UCUP208-108D1	NTN	PB 0130-1	UELP 205	SLB	PB 0052-2	UELP208-108D1W3	NTN	PB 0129-2	UELPL212-204D1W3	NTN	PB 0221-2
UCUP208-109D1	NTN	PB 0135-1	UELP 205-13	SLB	PB 0034-2	UELP208-109D1W3	NTN	PB 0133-2	UELPL212-205D1W3	NTN	PB 0226-2
UCUP208D1	NTN	PB 0140-1	UELP 205-14	SLB	PB 0040-2	UELP208-109D1W3	NTN	PB 0134-2	UELPL212-206D1W3	NTN	PB 0238-2
UCUP209-110D1	NTN	PB 0147-1	UELP 205-15	SLB	PB 0046-2	UELP208D1W3	NTN	PB 0138-2	UELPL212-207D1W3	NTN	PB 0243-2
UCUP209-111D1	NTN	PB 0152-1	UELP 205-16	SLB	PB 0060-2	UELP208D1W3	NTN	PB 0139-2	UELPL212D1W3	NTN	PB 0231-2
UCUP209-112D1	NTN	PB 0157-1	UELP 206	SLB	PB 0078-2	UELP209-110D1W3	NTN	PB 0146-2	UGP 204 + ER	NACHI	PB 0029-2
UCUP209D1	NTN	PB 0162-1	UELP 206-17	SLB	PB 0066-2	UELP209-111D1W3	NTN	PB 0151-2	UGP 204-12 + ER	NACHI	PB 0025-2
UCUP210-113D1	NTN	PB 0169-1	UELP 206-18	SLB	PB 0072-2	UELP209-112D1W3	NTN	PB 0156-2	UGP 205 + ER	NACHI	PB 0052-2
UCUP210-114D1	NTN	PB 0174-1	UELP 206-19	SLB	PB 0086-2	UELP209D1W3	NTN	PB 0161-2	UGP 205-14 + ER	NACHI	PB 0040-2
UCUP210-115D1	NTN	PB 0179-1	UELP 206-20	SLB	PB 0093-2	UELP210-113D1W3	NTN	PB 0168-2	UGP 205-15 + ER	NACHI	PB 0046-2
UCUP210-200D1	NTN	PB 0191-1	UELP 207	SLB	PB 0116-2	UELP210-114D1W3	NTN	PB 0173-2	UGP 205-16 + ER	NACHI	PB 0060-2
UCUP210D1	NTN	PB 0184-1	UELP 207-20	SLB	PB 0096-2	UELP210-115D1W3	NTN	PB 0178-2	UGP 206 + ER	NACHI	PB 0078-2
UELAK 204	SLB	PB 0028-2	UELP 207-21	SLB	PB 0104-2	UELP210-200D1W3	NTN	PB 0190-2	UGP 206-18 + ER	NACHI	PB 0072-2
UELAK 204-12	SLB	PB 0024-2	UELP 207-22	SLB	PB 0110-2	UELP210D1W3	NTN	PB 0183-2	UGP 206-19 + ER	NACHI	PB 0086-2
UELAK 205	SLB	PB 0051-2	UELP 207-23	SLB	PB 0124-2	UELP211-200D1W3	NTN	PB 0193-2	UGP 206-20 + ER	NACHI	PB 0093-2
UELAK 205-13	SLB	PB 0033-2	UELP 208	SLB	PB 0139-2	UELP211-201D1W3	NTN	PB 0200-2	UGP 207 + ER	NACHI	PB 0116-2
UELAK 205-14	SLB	PB 0039-2	UELP 208-24	SLB	PB 0129-2	UELP211-202D1W3	NTN	PB 0205-2	UGP 207-20 + ER	NACHI	PB 0096-2
UELAK 205-15	SLB	PB 0045-2	UELP 208-25	SLB	PB 0134-2	UELP211-203D1W3	NTN	PB 0217-2	UGP 207-21 + ER	NACHI	PB 0104-2
UELAK 205-16	SLB	PB 0059-2	UELP 209	SLB	PB 0161-2	UELP211D1W3	NTN	PB 0210-2	UGP 207-22 + ER	NACHI	PB 0110-2
UELAK 206	SLB	PB 0077-2	UELP 209-26	SLB	PB 0146-2	UELP212-204D1W3	NTN	PB 0222-2	UGP 207-23 + ER	NACHI	PB 0124-2
UELAK 206-17	SLB	PB 0065-2	UELP 209-27	SLB	PB 0151-2	UELP212-205D1W3	NTN	PB 0227-2	UGP 208 + ER	NACHI	PB 0139-2
UELAK 206-18	SLB	PB 0071-2	UELP 209-28	SLB	PB 0156-2	UELP212-206D1W3	NTN	PB 0239-2	UGP 208-24 + ER	NACHI	PB 0129-2
UELAK 206-19	SLB	PB 0085-2	UELP 210	SLB	PB 0183-2	UELP212-207D1W3	NTN	PB 0244-2	UGP 208-25 + ER	NACHI	PB 0134-2
UELAK 206-20	SLB	PB 0092-2	UELP 210-29	SLB	PB 0168-2	UELP212D1W3	NTN	PB 0232-2	UGP 209 + ER	NACHI	PB 0161-2
UELAK 207	SLB	PB 0115-2	UELP 210-30	SLB	PB 0173-2	UELP213-208D1W3	NTN	PB 0249-2	UGP 209-26 + ER	NACHI	PB 0146-2
UELAK 207-20	SLB	PB 0095-2	UELP 210-31	SLB	PB 0178-2	UELP213-209D1W3	NTN	PB 0259-2	UGP 209-27 + ER	NACHI	PB 0151-2
UELAK 207-21	SLB	PB 0103-2	UELP 210-32	SLB	PB 0190-2	UELP213D1W3	NTN	PB 0254-2	UGP 209-28 + ER	NACHI	PB 0156-2
UELAK 207-22	SLB	PB 0109-2	UELP 211	SLB	PB 0210-2	UELP214-210D1W3	NTN	PB 0264-2	UGP 210 + ER	NACHI	PB 0183-2
UELAK 207-23	SLB	PB 0123-2	UELP 211-32	SLB	PB 0193-2	UELP214-211D1W3	NTN	PB 0268-2	UGP 210-30 + ER	NACHI	PB 0173-2
UELAK 208	SLB	PB 0138-2	UELP 211-33	SLB	PB 0200-2	UELP214-212D1W3	NTN	PB 0272-2	UGP 210-31 + ER	NACHI	PB 0178-2
UELAK 208-24	SLB	PB 0128-2	UELP 211-34	SLB	PB 0205-2	UELP214D1W3	NTN	PB 0276-2	UGP 211 + ER	NACHI	PB 0210-2
UELAK 208-25	SLB	PB 0133-2	UELP 211-35	SLB	PB 0217-2	UELP215-213D1W3	NTN	PB 0280-2	UGP 211-32 + ER	NACHI	PB 0193-2
UELAK 209	SLB	PB 0160-2	UELP 212	SLB	PB 0232-2	UELP215-214D1W3	NTN	PB 0284-2	UGP 211-34 + ER	NACHI	PB 0205-2
UELAK 209-26	SLB	PB 0145-2	UELP 212-36	SLB	PB 0222-2	UELP215-215D1W3	NTN	PB 0288-2	UGP 211-35 + ER	NACHI	PB 0217-2
UELAK 209-27	SLB	PB 0150-2	UELP 212-37	SLB	PB 0227-2	UELP215-300D1W3	NTN	PB 0296-2	UGP 212 + ER	NACHI	PB 0232-2
UELAK 209-28	SLB	PB 0155-2	UELP 212-38	SLB	PB 0239-2	UELP215D1W3	NTN	PB 0292-2	UGP 212-36 + ER	NACHI	PB 0222-2
UELAK 210	SLB	PB 0182-2	UELP 212-39	SLB	PB 0244-2	UELPL204D1W3	NTN	PB 0028-2	UGP 212-38 + ER	NACHI	PB 0239-2
UELAK 210-29	SLB	PB 0167-2	UELP 213	SLB	PB 0254-2	UELPL205-013D1W3	NTN	PB 0033-2	UGP 212-39 + ER	NACHI	PB 0244-2
UELAK 210-30	SLB	PB 0172-2	UELP 213-40	SLB	PB 0249-2	UELPL205-014D1W3	NTN	PB 0039-2	UKP 205	SLB	PB 0030-1
UELAK 210-31	SLB	PB 0177-2	UELP 213-41	SLB	PB 0259-2	UELPL205-015D1W3	NTN	PB 0045-2	UKP 205	FYH	PB 0030-1
UELAK 210-32	SLB	PB 0189-2	UELP 214	SLB	PB 0276-2	UELPL205-100D1W3	NTN	PB 0059-2	UKP 205	NACHI	PB 0030-1
UELAK 211	SLB	PB 0209-2	UELP 214-42	SLB	PB 0264-2	UELPL205D1W3	NTN	PB 0051-2	UKP 205	NSK	PB 0030-1
UELAK 211-32	SLB	PB 0192-2	UELP 214-43	SLB	PB 0268-2	UELPL206-101D1W3	NTN	PB 0065-2	UKP 206	SLB	PB 0054-1
UELAK 211-33	SLB	PB 0199-2	UELP 214-44	SLB	PB 0272-2	UELPL206-102D1W3	NTN	PB 0071-2	UKP 206	ASAHI	PB 0054-1
UELAK 211-34	SLB	PB 0204-2	UELP 215	SLB	PB 0292-2	UELPL206-103D1W3	NTN	PB 0085-2	UKP 206	FYH	PB 0054-1
UELAK 211-35	SLB	PB 0216-2	UELP 215-45	SLB	PB 0280-2	UELPL206-104D1W3	NTN	PB 0092-2	UKP 206	NACHI	PB 0054-1
UELAK 212	SLB	PB 0231-2	UELP 215-46	SLB	PB 0284-2	UELPL206D1W3	NTN	PB 0077-2	UKP 206	NSK	PB 0054-1
UELAK 212-36	SLB	PB 0221-2	UELP 215-47	SLB	PB 0288-2	UELPL207-104D1W3	NTN	PB 0095-2	UKP 207	SLB	PB 0080-1
UELAK 212-37	SLB	PB 0226-2	UELP 215-48	SLB	PB 0296-2	UELPL207-105D1W3	NTN	PB 0103-2	UKP 207	ASAHI	PB 0080-1
UELAK 212-38	SLB	PB 0238-2	UELPL204-012D1W3	NTN	PB 0025-2	UELPL207-106D1W3	NTN	PB 0109-2	UKP 207	FYH	PB 0080-1
UELAK 212-39	SLB	PB 0243-2	UELPL204D1W3	NTN	PB 0029-2	UELPL207-107D1W3	NTN	PB 0123-2	UKP 207	NACHI	PB 0080-1
UELAK 213	SLB	PB 0253-2	UELPL205-013D1W3	NTN	PB 0034-2	UELPL207D1W3	NTN	PB 0115-2	UKP 208	SLB	PB 0118-1
UELAK 213-40	SLB	PB 0248-2	UELPL205-014D1W3	NTN	PB 0040-2	UELPL209-110D1W3	NTN	PB 0145-2	UKP 208	ASAHI	PB 0118-1
UELAK 214	SLB	PB 0275-2	UELPL205-015D1W3	NTN	PB 0046-2	UELPL209-111D1W3	NTN	PB 0150-2	UKP 208	FYH	PB 0118-1
UELAK 214-43	SLB	PB 0267-2	UELPL205D1W3	NTN	PB 0052-2	UELPL209D1W3	NTN	PB 0160-2	UKP 208	NACHI	PB 0118-1
UELAK 214-44	SLB	PB 0271-2	UELPL206-101D1W3	NTN	PB 0066-2	UELPL210-113D1W3	NTN	PB 0167-2	UKP 208	NSK	PB 0118-1
UELAK 215	SLB	PB 0291-2	UELPL206-102D1W3	NTN	PB 0072-2	UELPL210-114D1W3	NTN	PB 0172-2	UKP 209	SLB	PB 0141-1
UELAK 215-46	SLB	PB 0283-2	UELPL206-103D1W3	NTN	PB 0086-2	UELPL210-115D1W3	NTN	PB 0177-2	UKP 209	ASAHI	PB 0141-1
UELAK 215-47	SLB	PB 0287-2	UELPL206-104D1W3	NTN	PB 0093-2						
UELPL 201	SLB	PB 0002-2									

BY PART NUMBER

Part No.	Brand	Group No.	Part No.	Brand	Group No.	Part No.	Brand	Group No.	Part No.	Brand	Group No.
UKP 209	FYH	PB 0141-1	VAK-1-7/8	FAFNIR	PB 0172-3	VPE-220S	BROWNING	PB 0093-2	VPLS-232	BROWNING	PB 0192-1
UKP 209	NACHI	PB 0141-1	VAK-1-9/16	FAFNIR	PB 0133-3	VPE-222	BROWNING	PB 0110-2	VPLS-235	BROWNING	PB 0216-1
UKP 209	NSK	PB 0141-1	VAK-2	FAFNIR	PB 0192-3	VPE-223	BROWNING	PB 0124-2	VPLS-236	BROWNING	PB 0221-1
UKP 210	SLB	PB 0163-1	VAK-20	FAFNIR	PB 0028-3	VPE-224	BROWNING	PB 0129-2	VPLS-239	BROWNING	PB 0243-1
UKP 210	ASAHI	PB 0163-1	VAK-2-1/16	FAFNIR	PB 0199-3	VPE-226	BROWNING	PB 0146-2	VPLS-243	BROWNING	PB 0267-1
UKP 210	FYH	PB 0163-1	VAK-2-1/8	FAFNIR	PB 0204-3	VPE-227	BROWNING	PB 0151-2	VPLS-247	BROWNING	PB 0287-1
UKP 210	NACHI	PB 0163-1	VAK-2-3/16	FAFNIR	PB 0216-3	VPE-228	BROWNING	PB 0156-2	VPS-112	BROWNING	PB 0025-4
UKP 210	NSK	PB 0163-1	VAK-25	FAFNIR	PB 0051-3	VPE-231	BROWNING	PB 0178-2	VPS-114	BROWNING	PB 0040-4
UKP 211	SLB	PB 0185-1	VAK-2S	FAFNIR	PB 0189-3	VPE-232	BROWNING	PB 0193-2	VPS-115	BROWNING	PB 0046-4
UKP 211	ASAHI	PB 0185-1	VAK-3/4	FAFNIR	PB 0024-3	VPE-235	BROWNING	PB 0217-2	VPS-116	BROWNING	PB 0060-4
UKP 211	FYH	PB 0185-1	VAK-30	FAFNIR	PB 0077-3	VPE-236	BROWNING	PB 0222-2	VPS-118	BROWNING	PB 0072-4
UKP 211	NACHI	PB 0185-1	VAK-35	FAFNIR	PB 0115-3	VPE-239	BROWNING	PB 0244-2	VPS-119	BROWNING	PB 0086-4
UKP 211	NSK	PB 0185-1	VAK-40	FAFNIR	PB 0138-3	VPE-247	BROWNING	PB 0288-2	VPS-120S	BROWNING	PB 0093-4
UKP 212	SLB	PB 0213-1	VAK-45	FAFNIR	PB 0160-3	VPLE-112	BROWNING	PB 0024-3	VPS-122	BROWNING	PB 0110-4
UKP 212	ASAHI	PB 0213-1	VAK-50	FAFNIR	PB 0182-3	VPLE-114	BROWNING	PB 0039-3	VPS-123	BROWNING	PB 0124-4
UKP 212	FYH	PB 0213-1	VAK-55	FAFNIR	PB 0209-3	VPLE-115	BROWNING	PB 0045-3	VPS-212	BROWNING	PB 0025-1
UKP 212	NACHI	PB 0213-1	VAK-7/8	FAFNIR	PB 0039-3	VPLE-116	BROWNING	PB 0059-3	VPS-214	BROWNING	PB 0040-1
UKP 212	NSK	PB 0213-1	VAS-1	FAFNIR	PB 0060-3	VPLE-118	BROWNING	PB 0071-3	VPS-215	BROWNING	PB 0046-1
UKP 213	SLB	PB 0234-1	VAS-1-1/16	FAFNIR	PB 0066-3	VPLE-119	BROWNING	PB 0085-3	VPS-216	BROWNING	PB 0060-1
UKP 213	ASAHI	PB 0234-1	VAS-1-1/2	FAFNIR	PB 0129-3	VPLE-120S	BROWNING	PB 0092-3	VPS-218	BROWNING	PB 0072-1
UKP 213	FYH	PB 0234-1	VAS-1-1/4	FAFNIR	PB 0096-3	VPLE-122	BROWNING	PB 0109-3	VPS-219	BROWNING	PB 0086-1
UKP 213	NACHI	PB 0234-1	VAS-1-1/4S	FAFNIR	PB 0093-3	VPLE-123	BROWNING	PB 0123-3	VPS-220	BROWNING	PB 0096-1
UKP 213	NSK	PB 0234-1	VAS-1-1/8	FAFNIR	PB 0072-3	VPLE-212	BROWNING	PB 0024-2	VPS-220S	BROWNING	PB 0093-1
UKP205D1	NTN	PB 0030-1	VAS-1-11/16	FAFNIR	PB 0151-3	VPLE-214	BROWNING	PB 0039-2	VPS-222	BROWNING	PB 0110-1
UKP206D1	NTN	PB 0054-1	VAS-1-13/16	FAFNIR	PB 0168-3	VPLE-215	BROWNING	PB 0045-2	VPS-223	BROWNING	PB 0124-1
UKP207D1	NTN	PB 0080-1	VAS-1-15/16	FAFNIR	PB 0178-3	VPLE-216	BROWNING	PB 0059-2	VPS-224	BROWNING	PB 0129-1
UKP208D1	NTN	PB 0118-1	VAS-13/16	FAFNIR	PB 0034-3	VPLE-218	BROWNING	PB 0071-2	VPS-226	BROWNING	PB 0146-1
UKP209D1	NTN	PB 0141-1	VAS-1-3/16	FAFNIR	PB 0086-3	VPLE-219	BROWNING	PB 0085-2	VPS-227	BROWNING	PB 0151-1
UKP210D1	NTN	PB 0163-1	VAS-1-3/4	FAFNIR	PB 0156-3	VPLE-220	BROWNING	PB 0095-2	VPS-228	BROWNING	PB 0156-1
UKP211D1	NTN	PB 0185-1	VAS-1-3/8	FAFNIR	PB 0110-3	VPLE-220S	BROWNING	PB 0092-2	VPS-231	BROWNING	PB 0178-1
UKP212D1	NTN	PB 0213-1	VAS-15/16	FAFNIR	PB 0046-3	VPLE-222	BROWNING	PB 0109-2	VPS-232	BROWNING	PB 0193-1
UKP213D1	NTN	PB 0234-1	VAS-1-5/16	FAFNIR	PB 0104-3	VPLE-223	BROWNING	PB 0123-2	VPS-235	BROWNING	PB 0217-1
UKPA 205	SLB	PB 0031-1	VAS-1-5/8	FAFNIR	PB 0146-3	VPLE-224	BROWNING	PB 0128-2	VPS-236	BROWNING	PB 0222-1
UKPA 205	FYH	PB 0031-1	VAS-1-7/16	FAFNIR	PB 0124-3	VPLE-226	BROWNING	PB 0145-2	VPS-239	BROWNING	PB 0244-1
UKPA 206	SLB	PB 0055-1	VAS-1-7/8	FAFNIR	PB 0173-3	VPLE-227	BROWNING	PB 0150-2	VPS-247	BROWNING	PB 0288-1
UKPA 206	FYH	PB 0055-1	VAS-1-9/16	FAFNIR	PB 0134-3	VPLE-228	BROWNING	PB 0155-2	VPS-316	BROWNING	PB 0062-1
UKPA 207	SLB	PB 0081-1	VAS-2	FAFNIR	PB 0193-3	VPLE-231	BROWNING	PB 0177-2	VPS-319	BROWNING	PB 0088-1
UKPA 207	FYH	PB 0081-1	VAS-20	FAFNIR	PB 0029-3	VPLE-232	BROWNING	PB 0192-2	VPS-323	BROWNING	PB 0126-1
UKPA 208	SLB	PB 0119-1	VAS-2-1/16	FAFNIR	PB 0200-3	VPLE-235	BROWNING	PB 0216-2	VPS-324	BROWNING	PB 0131-1
UKPA 208	FYH	PB 0119-1	VAS-2-1/8	FAFNIR	PB 0205-3	VPLE-236	BROWNING	PB 0221-2	VPS-327	BROWNING	PB 0153-1
UKPA 209	SLB	PB 0142-1	VAS-2-3/16	FAFNIR	PB 0217-3	VPLE-239	BROWNING	PB 0243-2	VPS-328	BROWNING	PB 0158-1
UKPA 209	FYH	PB 0142-1	VAS-25	FAFNIR	PB 0052-3	VPLE-243	BROWNING	PB 0267-2	VPS-331	BROWNING	PB 0180-1
UKPA 210	SLB	PB 0164-1	VAS-2S	FAFNIR	PB 0190-3	VPLE-247	BROWNING	PB 0287-2	VPS-332	BROWNING	PB 0195-1
UKPA 210	FYH	PB 0164-1	VAS-3/4	FAFNIR	PB 0025-3	VPLS-112	BROWNING	PB 0024-4	VPS-335	BROWNING	PB 0219-1
UKPA 211	SLB	PB 0186-1	VAS-30	FAFNIR	PB 0078-3	VPLS-114	BROWNING	PB 0039-4	VPS-339	BROWNING	PB 0246-1
UKPA 211	FYH	PB 0186-1	VAS-35	FAFNIR	PB 0116-3	VPLS-115	BROWNING	PB 0045-4	VPS-340	BROWNING	PB 0251-1
UKPA 212	SLB	PB 0214-1	VAS-40	FAFNIR	PB 0139-3	VPLS-116	BROWNING	PB 0059-4	VPS-343	BROWNING	PB 0269-1
UKPA 212	FYH	PB 0214-1	VAS-45	FAFNIR	PB 0161-3	VPLS-118	BROWNING	PB 0071-4	VPS-347	BROWNING	PB 0289-1
UKPA 213	SLB	PB 0235-1	VAS-50	FAFNIR	PB 0183-3	VPLS-119	BROWNING	PB 0085-4	VPS-348	BROWNING	PB 0297-1
UKPA 213	FYH	PB 0235-1	VAS-55	FAFNIR	PB 0210-3	VPLS-120S	BROWNING	PB 0092-4	VTBS-208	BROWNING	PB 0006-1
VAK-1	FAFNIR	PB 0059-3	VAS-7/8	FAFNIR	PB 0040-3	VPLS-122	BROWNING	PB 0109-4	VTBS-210	BROWNING	PB 0015-1
VAK-1-1/16	FAFNIR	PB 0065-3	VPE-112	BROWNING	PB 0025-3	VPLS-123	BROWNING	PB 0123-4	VTBS-212	BROWNING	PB 0023-1
VAK-1-1/2	FAFNIR	PB 0128-3	VPE-114	BROWNING	PB 0040-3	VPLS-212	BROWNING	PB 0024-1	VTBS-214	BROWNING	PB 0041-1
VAK-1-1/4	FAFNIR	PB 0095-3	VPE-115	BROWNING	PB 0046-3	VPLS-214	BROWNING	PB 0039-1	VTBS-215	BROWNING	PB 0047-1
VAK-1-1/4S	FAFNIR	PB 0092-3	VPE-116	BROWNING	PB 0060-3	VPLS-215	BROWNING	PB 0045-1	VTBS-216	BROWNING	PB 0061-1
VAK-1-1/8	FAFNIR	PB 0071-3	VPE-118	BROWNING	PB 0072-3	VPLS-216	BROWNING	PB 0059-1	VTBS-218	BROWNING	PB 0073-1
VAK-1-11/16	FAFNIR	PB 0150-3	VPE-119	BROWNING	PB 0086-3	VPLS-218	BROWNING	PB 0071-1	VTBS-219	BROWNING	PB 0087-1
VAK-1-13/16	FAFNIR	PB 0167-3	VPE-120S	BROWNING	PB 0093-3	VPLS-219	BROWNING	PB 0085-1	VTBS-220	BROWNING	PB 0097-1
VAK-1-15/16	FAFNIR	PB 0177-3	VPE-122	BROWNING	PB 0110-3	VPLS-220	BROWNING	PB 0095-1	VTBS-220S	BROWNING	PB 0094-1
VAK-13/16	FAFNIR	PB 0033-3	VPE-123	BROWNING	PB 0124-3	VPLS-220S	BROWNING	PB 0092-1	VTBS-222	BROWNING	PB 0111-1
VAK-1-3/16	FAFNIR	PB 0085-3	VPE-212	BROWNING	PB 0025-2	VPLS-222	BROWNING	PB 0109-1	VTBS-223	BROWNING	PB 0125-1
VAK-1-3/4	FAFNIR	PB 0155-3	VPE-214	BROWNING	PB 0040-2	VPLS-223	BROWNING	PB 0123-1	VTBS-224	BROWNING	PB 0130-1
VAK-1-3/8	FAFNIR	PB 0109-3	VPE-215	BROWNING	PB 0046-2	VPLS-224	BROWNING	PB 0128-1	VTBS-226	BROWNING	PB 0147-1
VAK-15/16	FAFNIR	PB 0045-3	VPE-216	BROWNING	PB 0060-2	VPLS-226	BROWNING	PB 0145-1	VTBS-227	BROWNING	PB 0152-1
VAK-1-5/16	FAFNIR	PB 0103-3	VPE-218	BROWNING	PB 0072-2	VPLS-227	BROWNING	PB 0150-1	VTBS-228	BROWNING	PB 0157-1
VAK-1-5/8	FAFNIR	PB 0145-3	VPE-219	BROWNING	PB 0086-2	VPLS-228	BROWNING	PB 0155-1	VTBS-231	BROWNING	PB 0179-1
VAK-1-7/16	FAFNIR	PB 0123-3	VPE-220	BROWNING	PB 0096-2	VPLS-231	BROWNING	PB 0177-1	VTBS-232S	BROWNING	PB 0191-1

BY PART NUMBER

Part No.	Brand	Group No.	Part No.	Brand	Group No.	Part No.	Brand	Group No.	Part No.	Brand	Group No.
40MLA+1217-17ECG	SNR	FU 0027-1	AELPF206-104W3	NTN	FU 0160-1	ASPFL205-015	NTN	FU 0077-2	BFL 206	NACHI	FU 0143-4
40MSA+1217-17ECG	SNR	FU 0026-1	AELPF206W3	NTN	FU 0135-1	ASPFL205-100	NTN	FU 0102-2	BFL 206-18	ASAHI	FU 0130-4
40MSC1+210	LINK BELT	FU 0021-1	AELPF207-104W3	NTN	FU 0165-1	ASPFL206	NTN	FU 0136-2	BFL 206-18	NACHI	FU 0130-4
40MSC1+211	LINK BELT	FU 0031-1	AELPF207-105W3	NTN	FU 0181-1	ASPFL206-101	NTN	FU 0114-2	BFL 206-19	ASAHI	FU 0155-4
40MSC1+2B08	LINK BELT	FU 0006-1	AELPF207-106W3	NTN	FU 0192-1	ASPFL206-102	NTN	FU 0125-2	BFL 206-19	NACHI	FU 0155-4
40MSC1+2M17	LINK BELT	FU 0026-1	AELPF207-107W3	NTN	FU 0217-1	ASPFL206-103	NTN	FU 0150-2	BFL 207	ASAHI	FU 0211-4
40MST+210	LINK BELT	FU 0022-1	AELPF207W3	NTN	FU 0203-1	ASPFL206-104	NTN	FU 0161-2	BFL 207	NACHI	FU 0211-4
40MST+211	LINK BELT	FU 0032-1	AELPFL201-008W3	NTN	FU 0007-1	ASPFL206-105	NTN	FU 0204-2	BFL 207-20	ASAHI	FU 0174-4
40MST+2B08	LINK BELT	FU 0007-1	AELPFL201W3	NTN	FU 0002-1	ASPFL207-104	NTN	FU 0166-2	BFL 207-20	NACHI	FU 0174-4
40MST+2M17	LINK BELT	FU 0027-1	AELPFL202-009W3	NTN	FU 0012-1	ASPFL207-105	NTN	FU 0182-2	BFL 207-21	ASAHI	FU 0187-4
47MLA+1220-20ECG	SNR	FU 0047-1	AELPFL202-010W3	NTN	FU 0022-1	ASPFL207-106	NTN	FU 0193-2	BFL 207-21	NACHI	FU 0187-4
47MLA+1220-20G	SNR	FU 0047-2	AELPFL202W3	NTN	FU 0017-1	ASPFL207-107	NTN	FU 0218-2	BFL 207-22	ASAHI	FU 0198-4
47MSA+1220-20ECG	SNR	FU 0046-1	AELPFL203-011W3	NTN	FU 0032-1	BF 204	ASAHI	FU 0044-4	BFL 207-22	NACHI	FU 0198-4
47MSA+1220-20G	SNR	FU 0046-2	AELPFL203W3	NTN	FU 0027-1	BF 204	NACHI	FU 0044-4	BFL 207-23	ASAHI	FU 0223-4
47MSC1+212	LINK BELT	FU 0038-1	AELPFL204-012W3	NTN	FU 0039-1	BF 204-12	ASAHI	FU 0037-4	BFL 207-23	NACHI	FU 0223-4
47MSC1+2M20	LINK BELT	FU 0046-1	AELPFL204W3	NTN	FU 0047-1	BF 204-12	NACHI	FU 0037-4	BPF 1	ASAHI	FU 0001-2
47MST+212	LINK BELT	FU 0039-1	AELPFL205-013W3	NTN	FU 0055-1	BF 205	ASAHI	FU 0086-4	BPF 1	NACHI	FU 0001-2
47MST+2M20	LINK BELT	FU 0047-1	AELPFL205-014W3	NTN	FU 0066-1	BF 205	NACHI	FU 0086-4	BPF 1-8	ASAHI	FU 0006-2
52MLA+1225-25ECG	SNR	FU 0088-1	AELPFL205-015W3	NTN	FU 0077-1	BF 205-14	ASAHI	FU 0064-4	BPF 1-8	NACHI	FU 0006-2
52MLA+1225-25G	SNR	FU 0088-2	AELPFL205-100W3	NTN	FU 0102-1	BF 205-14	NACHI	FU 0064-4	BPF 2	ASAHI	FU 0016-2
52MSA+1225-25ECG	SNR	FU 0087-1	AELPFL205W3	NTN	FU 0088-1	BF 205-15	ASAHI	FU 0075-4	BPF 2	NACHI	FU 0016-2
52MSA+1225-25G	SNR	FU 0087-2	AELPFL206-101W3	NTN	FU 0114-1	BF 205-15	NACHI	FU 0075-4	BPF 2-10	ASAHI	FU 0021-2
52MSC1+214	LINK BELT	FU 0065-1	AELPFL206-102W3	NTN	FU 0125-1	BF 205-16	ASAHI	FU 0100-4	BPF 2-10	NACHI	FU 0021-2
52MSC1+215	LINK BELT	FU 0076-1	AELPFL206-103W3	NTN	FU 0150-1	BF 205-16	NACHI	FU 0100-4	BPF 2-9	ASAHI	FU 0011-2
52MSC1+216	LINK BELT	FU 0101-1	AELPFL206-104W3	NTN	FU 0161-1	BF 206	ASAHI	FU 0134-4	BPF 2-9	NACHI	FU 0011-2
52MSC1+2M25	LINK BELT	FU 0087-1	AELPFL206W3	NTN	FU 0136-1	BF 206	NACHI	FU 0134-4	BPF 3	ASAHI	FU 0026-2
52MST+214	LINK BELT	FU 0066-1	AELPFL207-104W3	NTN	FU 0166-1	BF 206-18	ASAHI	FU 0123-4	BPF 3	NACHI	FU 0026-2
52MST+215	LINK BELT	FU 0077-1	AELPFL207-105W3	NTN	FU 0182-1	BF 206-18	NACHI	FU 0123-4	BPF 3-11	ASAHI	FU 0031-2
52MST+216	LINK BELT	FU 0102-1	AELPFL207-106W3	NTN	FU 0193-1	BF 206-19	ASAHI	FU 0148-4	BPF 3-11	NACHI	FU 0031-2
52MST+2M25	LINK BELT	FU 0088-1	AELPFL207-107W3	NTN	FU 0218-1	BF 206-19	NACHI	FU 0148-4	BPF 4	ASAHI	FU 0046-2
62MLA+1230-30ECG	SNR	FU 0136-1	AELPFL207W3	NTN	FU 0204-1	BF 207	ASAHI	FU 0202-4	BPF 4	NACHI	FU 0046-2
62MLA+1230-30G	SNR	FU 0136-2	ASPF201	NTN	FU 0001-2	BF 207	NACHI	FU 0202-4	BPF 4-12	ASAHI	FU 0038-2
62MSA+1230-30ECG	SNR	FU 0135-1	ASPF201-008	NTN	FU 0006-2	BF 207-20	ASAHI	FU 0162-4	BPF 4-12	NACHI	FU 0038-2
62MSA+1230-30G	SNR	FU 0135-2	ASPF202	NTN	FU 0016-2	BF 207-20	NACHI	FU 0162-4	BPF 5	ASAHI	FU 0087-2
62MSC1+218	LINK BELT	FU 0124-1	ASPF202-009	NTN	FU 0011-2	BF 207-21	ASAHI	FU 0180-4	BPF 5	NACHI	FU 0087-2
62MSC1+219	LINK BELT	FU 0149-1	ASPF202-010	NTN	FU 0021-2	BF 207-21	NACHI	FU 0180-4	BPF 5-14	ASAHI	FU 0065-2
62MSC1+2E20	LINK BELT	FU 0160-1	ASPF203	NTN	FU 0026-2	BF 207-22	ASAHI	FU 0191-4	BPF 5-14	NACHI	FU 0065-2
62MST+2M30	LINK BELT	FU 0135-1	ASPF203-011	NTN	FU 0031-2	BF 207-22	NACHI	FU 0191-4	BPF 5-15	ASAHI	FU 0076-2
62MST+218	LINK BELT	FU 0125-1	ASPF204	NTN	FU 0046-2	BF 207-23	ASAHI	FU 0216-4	BPF 5-15	NACHI	FU 0076-2
62MST+219	LINK BELT	FU 0150-1	ASPF204-012	NTN	FU 0038-2	BF 207-23	NACHI	FU 0216-4	BPF 5-16	ASAHI	FU 0101-2
62MST+2E20	LINK BELT	FU 0161-1	ASPF205	NTN	FU 0087-2	BFC 204	NACHI	FU 0048-4	BPF 5-16	NACHI	FU 0101-2
62MST+2M30	LINK BELT	FU 0136-1	ASPF205-013	NTN	FU 0054-2	BFC 204-12	NACHI	FU 0040-4	BPF 6	ASAHI	FU 0135-2
72MLA+1235-35ECG	SNR	FU 0204-1	ASPF205-014	NTN	FU 0065-2	BFC 205	NACHI	FU 0092-4	BPF 6	NACHI	FU 0135-2
72MLA+1235-35G	SNR	FU 0204-2	ASPF205-015	NTN	FU 0076-2	BFC 205-14	NACHI	FU 0069-4	BPF 6-18	ASAHI	FU 0124-2
72MSA+1235-35ECG	SNR	FU 0203-1	ASPF205-100	NTN	FU 0101-2	BFC 205-15	NACHI	FU 0080-4	BPF 6-18	NACHI	FU 0124-2
72MSA+1235-35G	SNR	FU 0203-2	ASPF206	NTN	FU 0135-2	BFC 205-16	NACHI	FU 0105-4	BPF 6-19	ASAHI	FU 0149-2
72MSC1+220	LINK BELT	FU 0165-1	ASPF206-101	NTN	FU 0113-2	BFC 206	NACHI	FU 0140-4	BPF 6-19	NACHI	FU 0149-2
72MSC1+222	LINK BELT	FU 0192-1	ASPF206-102	NTN	FU 0124-2	BFC 206-18	NACHI	FU 0128-4	BPF 7	ASAHI	FU 0203-2
72MSC1+223	LINK BELT	FU 0217-1	ASPF206-103	NTN	FU 0149-2	BFC 206-19	NACHI	FU 0153-4	BPF 7	NACHI	FU 0203-2
72MSC1+2M35	LINK BELT	FU 0203-1	ASPF206-104	NTN	FU 0160-2	BFC 207	NACHI	FU 0208-4	BPF 7-20	ASAHI	FU 0165-2
AELPF201-008W3	NTN	FU 0006-1	ASPF207	NTN	FU 0203-2	BFC 207-20	NACHI	FU 0170-4	BPF 7-20	NACHI	FU 0165-2
AELPF201W3	NTN	FU 0001-1	ASPF207-104	NTN	FU 0165-2	BFC 207-21	NACHI	FU 0185-4	BPF 7-21	ASAHI	FU 0181-2
AELPF202-009W3	NTN	FU 0011-1	ASPF207-105	NTN	FU 0181-2	BFC 207-22	NACHI	FU 0196-4	BPF 7-21	NACHI	FU 0181-2
AELPF202-010W3	NTN	FU 0021-1	ASPF207-106	NTN	FU 0192-2	BFC 207-23	NACHI	FU 0221-4	BPF 7-22	ASAHI	FU 0192-2
AELPF202W3	NTN	FU 0016-1	ASPF207-107	NTN	FU 0217-2	BFL 204	ASAHI	FU 0050-4	BPF 7-22	NACHI	FU 0192-2
AELPF203-011W3	NTN	FU 0031-1	ASPFL201	NTN	FU 0002-2	BFL 204	NACHI	FU 0050-4	BPF 7-23	ASAHI	FU 0217-2
AELPF203W3	NTN	FU 0026-1	ASPFL201-008	NTN	FU 0007-2	BFL 204-12	ASAHI	FU 0042-4	BPF 7-23	NACHI	FU 0217-2
AELPF204-012W3	NTN	FU 0038-1	ASPFL202	NTN	FU 0017-2	BFL 204-12	NACHI	FU 0042-4	BPFL 1	ASAHI	FU 0002-2
AELPF204W3	NTN	FU 0046-1	ASPFL202-009	NTN	FU 0012-2	BFL 205	ASAHI	FU 0094-4	BPFL 1	NACHI	FU 0002-2
AELPF205-013W3	NTN	FU 0054-1	ASPFL202-010	NTN	FU 0022-2	BFL 205	NACHI	FU 0094-4	BPFL 1-8	ASAHI	FU 0007-2
AELPF205-014W3	NTN	FU 0065-1	ASPFL203	NTN	FU 0027-2	BFL 205-14	ASAHI	FU 0071-4	BPFL 1-8	NACHI	FU 0007-2
AELPF205-015W3	NTN	FU 0076-1	ASPFL203-011	NTN	FU 0032-2	BFL 205-14	NACHI	FU 0071-4	BPFL 2	ASAHI	FU 0017-2
AELPF205-100W3	NTN	FU 0101-1	ASPFL204	NTN	FU 0047-2	BFL 205-15	ASAHI	FU 0082-4	BPFL 2	NACHI	FU 0017-2
AELPF205W3	NTN	FU 0087-1	ASPFL204-012	NTN	FU 0039-2	BFL 205-15	NACHI	FU 0082-4	BPFL 2-10	ASAHI	FU 0022-2
AELPF206-101W3	NTN	FU 0113-1	ASPFL205	NTN	FU 0088-2	BFL 205-16	ASAHI	FU 0107-4	BPFL 2-10	NACHI	FU 0022-2
AELPF206-102W3	NTN	FU 0124-1	ASPFL205-013	NTN	FU 0055-2	BFL 205-16	NACHI	FU 0107-4	BPFL 2-9	ASAHI	FU 0012-2
AELPF206-103W3	NTN	FU 0149-1	ASPFL205-014	NTN	FU 0066-2	BFL 206	ASAHI	FU 0143-4	BPFL 2-9	NACHI	FU 0012-2

BY PART NUMBER

Part No.	Brand	Group No.	Part No.	Brand	Group No.	Part No.	Brand	Group No.	Part No.	Brand	Group No.
BPFL 3	ASAHI	FU 0027-2	EWFL 207	NSK	FU 0211-2	F3-U2M25N	LINK BELT	FU 0099-1	FC1 1/4DEC	RHP	FU 0170-2
BPFL 3	NACHI	FU 0027-2	EWFL 208	NSK	FU 0253-2	F3-U2M30N	LINK BELT	FU 0133-1	FC1 1/4DECR	RHP	FU 0167-2
BPFL 3-11	ASAHI	FU 0032-2	EWFL 209	NSK	FU 0290-2	F3-U2M40N	LINK BELT	FU 0245-1	FC1 1/4EC	RHP	FU 0170-3
BPFL 3-11	NACHI	FU 0032-2	EWFL 210	NSK	FU 0330-2	F3-U2M45N	LINK BELT	FU 0295-1	FC1 1/4ECR	RHP	FU 0167-3
BPFL 4	ASAHI	FU 0047-2	EWFL 211	NSK	FU 0375-2	F3-U2M50N	LINK BELT	FU 0334-1	FC1 1/4R	RHP	FU 0167-1
BPFL 4	NACHI	FU 0047-2	EWFL 212	NSK	FU 0410-2	F3-U2M60N	LINK BELT	FU 0413-1	FC1 1/8	RHP	FU 0128-1
BPFL 4-12	ASAHI	FU 0039-2	F 1 FM	SKF	FU 0101-1	F3-U2M65N	LINK BELT	FU 0445-1	FC1 1/8DEC	RHP	FU 0128-2
BPFL 4-12	NACHI	FU 0039-2	F 1/2 FM	SKF	FU 0006-1	F3-U2M75N	LINK BELT	FU 0513-1	FC1 1/8EC	RHP	FU 0128-3
BPFL 5	ASAHI	FU 0088-2	F 1/16 FM	SKF	FU 0031-1	F3-W212U	LINK BELT	FU 0036-3	FC1 11/16	RHP	FU 0269-1
BPFL 5	NACHI	FU 0088-2	F 1-1/16 FM	SKF	FU 0113-1	F3-W214U	LINK BELT	FU 0074-3	FC1 11/16DEC	RHP	FU 0269-2
BPFL 5-14	ASAHI	FU 0066-2	F 1-1/4 AFM	SKF	FU 0160-1	F3-W215U	LINK BELT	FU 0085-3	FC1 11/16EC	RHP	FU 0269-3
BPFL 5-14	NACHI	FU 0066-2	F 1-1/4 FM	SKF	FU 0165-1	F3-W216U	LINK BELT	FU 0110-3	FC1 15/16	RHP	FU 0317-1
BPFL 5-15	ASAHI	FU 0077-2	F 1-1/8 FM	SKF	FU 0124-1	F3-W218E	LINK BELT	FU 0122-3	FC1 15/16DEC	RHP	FU 0317-2
BPFL 5-15	NACHI	FU 0077-2	F 13/16 FM	SKF	FU 0054-1	F3-W219E	LINK BELT	FU 0147-3	FC1 15/16EC	RHP	FU 0317-3
BPFL 5-16	ASAHI	FU 0102-2	F 1-3/16 FM	SKF	FU 0149-1	F3-W220E	LINK BELT	FU 0179-3	FC1 3/16	RHP	FU 0153-1
BPFL 5-16	NACHI	FU 0102-2	F 1-3/8 FM	SKF	FU 0192-1	F3-W222E	LINK BELT	FU 0201-3	FC1 3/16DEC	RHP	FU 0153-2
BPFL 6	ASAHI	FU 0136-2	F 15 FM	SKF	FU 0016-1	F3-W223E	LINK BELT	FU 0226-3	FC1 3/16EC	RHP	FU 0153-3
BPFL 6	NACHI	FU 0136-2	F 15/16 FM	SKF	FU 0076-1	F3-W224E	LINK BELT	FU 0227-3	FC1 3/4	RHP	FU 0278-1
BPFL 6-18	ASAHI	FU 0125-2	F 1-5/16 FM	SKF	FU 0181-1	F3-W226U	LINK BELT	FU 0265-3	FC1 3/4DEC	RHP	FU 0278-2
BPFL 6-18	NACHI	FU 0125-2	F 17 FM	SKF	FU 0026-1	F3-W227U	LINK BELT	FU 0274-3	FC1 3/4EC	RHP	FU 0278-3
BPFL 6-19	ASAHI	FU 0150-2	F 1-7/16 FM	SKF	FU 0217-1	F3-W228U	LINK BELT	FU 0283-3	FC1 3/8	RHP	FU 0196-1
BPFL 6-19	NACHI	FU 0150-2	F 20 FM	SKF	FU 0046-1	F3-W231U	LINK BELT	FU 0322-3	FC1 3/8DEC	RHP	FU 0196-2
BPFL 7	ASAHI	FU 0204-2	F 25 FM	SKF	FU 0087-1	F3-W2E20E	LINK BELT	FU 0158-3	FC1 3/8EC	RHP	FU 0196-3
BPFL 7	NACHI	FU 0204-2	F 3/4 FM	SKF	FU 0038-1	F3-W2E32U	LINK BELT	FU 0350-3	FC1 5/8	RHP	FU 0260-1
BPFL 7-20	ASAHI	FU 0166-2	F 30 FM	SKF	FU 0135-1	F3-Y212N	LINK BELT	FU 0036-2	FC1 5/8DEC	RHP	FU 0260-2
BPFL 7-20	NACHI	FU 0166-2	F 35 FM	SKF	FU 0203-1	F3-Y214N	LINK BELT	FU 0074-2	FC1 5/8EC	RHP	FU 0260-3
BPFL 7-21	ASAHI	FU 0182-2	F 5/8 FM	SKF	FU 0021-1	F3-Y215N	LINK BELT	FU 0085-2	FC1 7/16	RHP	FU 0221-1
BPFL 7-21	NACHI	FU 0182-2	F 7/8 FM	SKF	FU 0065-1	F3-Y216N	LINK BELT	FU 0110-2	FC1 7/16DEC	RHP	FU 0221-2
BPFL 7-22	ASAHI	FU 0193-2	F3-220E	LINK BELT	FU 0179-4	F3-Y218N	LINK BELT	FU 0122-2	FC1 7/16EC	RHP	FU 0221-3
BPFL 7-22	NACHI	FU 0193-2	F3-235N	LINK BELT	FU 0386-1	F3-Y219N	LINK BELT	FU 0147-2	FC1 7/8	RHP	FU 0308-1
BPFL 7-23	ASAHI	FU 0218-2	F3-S212E	LINK BELT	FU 0036-4	F3-Y220N	LINK BELT	FU 0179-2	FC1 7/8DEC	RHP	FU 0308-2
BPFL 7-23	NACHI	FU 0218-2	F3-S214E	LINK BELT	FU 0074-4	F3-Y222N	LINK BELT	FU 0201-2	FC1 7/8EC	RHP	FU 0308-3
ENPF 201	NSK	FU 0001-1	F3-S215E	LINK BELT	FU 0085-4	F3-Y223N	LINK BELT	FU 0226-2	FC15/16	RHP	FU 0080-1
ENPF 202	NSK	FU 0016-1	F3-S216E	LINK BELT	FU 0110-4	F3-Y224N	LINK BELT	FU 0227-2	FC15/16DEC	RHP	FU 0080-2
ENPF 203	NSK	FU 0026-1	F3-S218E	LINK BELT	FU 0122-4	F3-Y226N	LINK BELT	FU 0265-2	FC15/16EC	RHP	FU 0080-3
ENPF 204	NSK	FU 0046-1	F3-S219E	LINK BELT	FU 0147-4	F3-Y227N	LINK BELT	FU 0274-2	FC1A	RHP	FU 0105-4
ENPF 205	NSK	FU 0087-1	F3-S222E	LINK BELT	FU 0201-4	F3-Y228N	LINK BELT	FU 0283-2	FC1EC	RHP	FU 0105-3
ENPF 206	NSK	FU 0135-1	F3-S223E	LINK BELT	FU 0226-4	F3-Y231N	LINK BELT	FU 0322-2	FC2EDEC	RHP	FU 0105-2
ENPF 207	NSK	FU 0203-1	F3-S224E	LINK BELT	FU 0227-4	F3-Y232N	LINK BELT	FU 0351-2	FC2	RHP	FU 0342-1
ENPFL 201	NSK	FU 0002-1	F3-S2E20E	LINK BELT	FU 0158-4	F3-Y235N	LINK BELT	FU 0386-2	FC2 1/4	RHP	FU 0390-1
ENPFL 202	NSK	FU 0017-1	F3-U212N	LINK BELT	FU 0036-1	F3-Y236N	LINK BELT	FU 0394-2	FC2 1/4DEC	RHP	FU 0390-2
ENPFL 203	NSK	FU 0027-1	F3-U214N	LINK BELT	FU 0074-1	F3-Y238N	LINK BELT	FU 0421-2	FC2 1/8	RHP	FU 0363-1
ENPFL 204	NSK	FU 0047-1	F3-U215N	LINK BELT	FU 0085-1	F3-Y239N	LINK BELT	FU 0429-2	FC2 1/8DEC	RHP	FU 0363-2
ENPFL 205	NSK	FU 0088-1	F3-U216N	LINK BELT	FU 0110-1	F3-Y2E20N	LINK BELT	FU 0158-2	FC2 3/16	RHP	FU 0382-1
ENPFL 206	NSK	FU 0136-1	F3-U218N	LINK BELT	FU 0122-1	F3-Y2E32N	LINK BELT	FU 0350-2	FC2 3/16DEC	RHP	FU 0382-2
ENPFL 207	NSK	FU 0204-1	F3-U219N	LINK BELT	FU 0147-1	FB16203	FAG	FU 0026-1	FC2 3/8	RHP	FU 0417-1
EWFL 204	NSK	FU 0044-2	F3-U220N	LINK BELT	FU 0179-1	FB16203/15	FAG	FU 0016-1	FC2 3/8DEC	RHP	FU 0417-2
EWFL 205	NSK	FU 0086-2	F3-U222N	LINK BELT	FU 0201-1	FB16204	FAG	FU 0046-1	FC2 7/16	RHP	FU 0425-1
EWFL 206	NSK	FU 0134-2	F3-U223N	LINK BELT	FU 0215-1	FB16204.012	FAG	FU 0038-1	FC2 7/16DEC	RHP	FU 0425-2
EWFL 207	NSK	FU 0202-2	F3-U223N	LINK BELT	FU 0226-1	FB16205	FAG	FU 0087-1	FC20	RHP	FU 0048-1
EWFL 208	NSK	FU 0246-2	F3-U224N	LINK BELT	FU 0227-1	FB16205.014	FAG	FU 0065-1	FC20A	RHP	FU 0048-4
EWFL 209	NSK	FU 0284-2	F3-U226N	LINK BELT	FU 0265-1	FB16205.100	FAG	FU 0101-1	FC20DEC	RHP	FU 0048-2
EWFL 210	NSK	FU 0323-2	F3-U227N	LINK BELT	FU 0274-1	FB16206	FAG	FU 0135-1	FC20EC	RHP	FU 0048-3
EWFL 211	NSK	FU 0368-2	F3-U228N	LINK BELT	FU 0283-1	FB16206.101	FAG	FU 0113-1	FC25	RHP	FU 0092-1
EWFL 212	NSK	FU 0403-2	F3-U231N	LINK BELT	FU 0322-1	FB16206.102	FAG	FU 0124-1	FC25A	RHP	FU 0092-4
EWFC 204	NSK	FU 0048-2	F3-U232N	LINK BELT	FU 0351-1	FB16206.103	FAG	FU 0149-1	FC25DEC	RHP	FU 0092-2
EWFC 205	NSK	FU 0092-2	F3-U236N	LINK BELT	FU 0394-1	FB16206.104	FAG	FU 0160-1	FC25EC	RHP	FU 0092-3
EWFC 206	NSK	FU 0140-2	F3-U238N	LINK BELT	FU 0421-1	FB16207	FAG	FU 0203-1	FC2DEC	RHP	FU 0342-2
EWFC 207	NSK	FU 0208-2	F3-U239N	LINK BELT	FU 0429-1	FB16207.106	FAG	FU 0192-1	FC2R	RHP	FU 0339-1
EWFC 208	NSK	FU 0250-2	F3-U240N	LINK BELT	FU 0437-1	FC1	RHP	FU 0105-1	FC3/4	RHP	FU 0040-1
EWFC 209	NSK	FU 0288-2	F3-U243N	LINK BELT	FU 0469-1	FC1 1/2	RHP	FU 0231-1	FC3/4A	RHP	FU 0040-4
EWFC 210	NSK	FU 0327-2	F3-U244N	LINK BELT	FU 0477-1	FC1 1/2A	RHP	FU 0231-4	FC3/4DEC	RHP	FU 0040-2
EWFC 211	NSK	FU 0372-2	F3-U247N	LINK BELT	FU 0506-1	FC1 1/2DEC	RHP	FU 0231-2	FC3/4EC	RHP	FU 0040-3
EWFC 212	NSK	FU 0407-2	F3-U2E20N	LINK BELT	FU 0158-1	FC1 1/2EC	RHP	FU 0231-3	FC30	RHP	FU 0140-1
EWFL 204	NSK	FU 0050-2	F3-U2E32N	LINK BELT	FU 0350-1	FC1 1/4	RHP	FU 0170-1	FC30A	RHP	FU 0140-4
EWFL 205	NSK	FU 0094-2	F3-U2E48N	LINK BELT	FU 0520-1	FC1 1/4A	RHP	FU 0170-4	FC30DEC	RHP	FU 0140-2
EWFL 206	NSK	FU 0143-2	F3-U2M20N	LINK BELT	FU 0043-1	FC1 1/4AR	RHP	FU 0167-4	FC30EC	RHP	FU 0140-3

BY PART NUMBER

Part No.	Brand	Group No.	Part No.	Brand	Group No.	Part No.	Brand	Group No.	Part No.	Brand	Group No.
FC35	RHP	FU 0208-1	FT 1-1/4 FM	SKF	FU 0166-1	FX3-W2E20E	LINK BELT	FU 0171-3	FY 1-7/16 WM	SKF	FU 0216-2
FC35A	RHP	FU 0208-4	FT 1-1/8 FM	SKF	FU 0125-1	FX3-W2E32U	LINK BELT	FU 0343-3	FY 1-7/8 FM	SKF	FU 0305-3
FC35DEC	RHP	FU 0208-2	FT 13/16 FM	SKF	FU 0055-1	FX3-Y212N	LINK BELT	FU 0041-2	FY 1-7/8 TM	SKF	FU 0305-1
FC35EC	RHP	FU 0208-3	FT 1-3/16 FM	SKF	FU 0150-1	FX3-Y214N	LINK BELT	FU 0070-2	FY 1-7/8 WM	SKF	FU 0305-2
FC40	RHP	FU 0250-1	FT 1-3/8 FM	SKF	FU 0193-1	FX3-Y215N	LINK BELT	FU 0081-2	FY 1-9/16 FM	SKF	FU 0237-3
FC40A	RHP	FU 0250-4	FT 15 FM	SKF	FU 0017-1	FX3-Y216N	LINK BELT	FU 0106-2	FY 1-9/16 TM	SKF	FU 0237-1
FC40DEC	RHP	FU 0250-2	FT 15/16 FM	SKF	FU 0077-1	FX3-Y218N	LINK BELT	FU 0129-2	FY 1-9/16 WM	SKF	FU 0237-2
FC40EC	RHP	FU 0250-3	FT 17 FM	SKF	FU 0027-1	FX3-Y219N	LINK BELT	FU 0154-2	FY 2 FM	SKF	FU 0336-3
FC45	RHP	FU 0288-1	FT 1-7/16 FM	SKF	FU 0218-1	FX3-Y220N	LINK BELT	FU 0173-2	FY 2 TM	SKF	FU 0336-1
FC45DEC	RHP	FU 0288-2	FT 20 FM	SKF	FU 0047-1	FX3-Y222N	LINK BELT	FU 0197-2	FY 2 WM	SKF	FU 0336-2
FC45EC	RHP	FU 0288-3	FT 25 FM	SKF	FU 0088-1	FX3-Y223N	LINK BELT	FU 0222-2	FY 20 FM	SKF	FU 0044-3
FC50	RHP	FU 0327-1	FT 3/4 FM	SKF	FU 0039-1	FX3-Y224N	LINK BELT	FU 0232-2	FY 20 TM	SKF	FU 0044-1
FC50DEC	RHP	FU 0327-2	FT 30 FM	SKF	FU 0136-1	FX3-Y226N	LINK BELT	FU 0262-2	FY 20 WM	SKF	FU 0044-2
FC50EC	RHP	FU 0327-3	FT 35 FM	SKF	FU 0204-1	FX3-Y227N	LINK BELT	FU 0271-2	FY 2-1/2 TM	SKF	FU 0430-1
FC55	RHP	FU 0372-1	FT 5/8 FM	SKF	FU 0022-1	FX3-Y228N	LINK BELT	FU 0280-2	FY 2-1/4 TM	SKF	FU 0387-1
FC55DEC	RHP	FU 0372-2	FT 7/8 FM	SKF	FU 0066-1	FX3-Y231N	LINK BELT	FU 0318-2	FY 2-1/4 WM	SKF	FU 0387-2
FC60	RHP	FU 0407-1	FX3-S212E	LINK BELT	FU 0041-4	FX3-Y232N	LINK BELT	FU 0345-2	FY 2-15/16 TM	SKF	FU 0501-1
FC60DEC	RHP	FU 0407-2	FX3-S214E	LINK BELT	FU 0070-4	FX3-Y235N	LINK BELT	FU 0383-2	FY 2-3/16 FM	SKF	FU 0379-3
FC7/8	RHP	FU 0069-1	FX3-S215E	LINK BELT	FU 0081-4	FX3-Y2E20N	LINK BELT	FU 0171-2	FY 2-3/16 TM	SKF	FU 0379-1
FC7/8DEC	RHP	FU 0069-2	FX3-S216E	LINK BELT	FU 0106-4	FX3-Y2E32N	LINK BELT	FU 0343-2	FY 2-3/16 WM	SKF	FU 0379-2
FC7/8EC	RHP	FU 0069-3	FX3-S218E	LINK BELT	FU 0129-4	FY 1 FM	SKF	FU 0100-3	FY 25 FM	SKF	FU 0086-3
FE-U2M55N	LINK BELT	FU 0378-1	FX3-S219E	LINK BELT	FU 0154-4	FY 1 TM	SKF	FU 0100-1	FY 25 TM	SKF	FU 0086-1
FG16204	FAG	FU 0044-3	FX3-S220E	LINK BELT	FU 0173-4	FY 1 WM	SKF	FU 0100-2	FY 25 WM	SKF	FU 0086-2
FG16204.012	FAG	FU 0037-3	FX3-S222E	LINK BELT	FU 0197-4	FY 1-1/16 FM	SKF	FU 0112-3	FY 2-7/16 TM	SKF	FU 0422-1
FG16205	FAG	FU 0086-3	FX3-S223E	LINK BELT	FU 0222-4	FY 1-1/16 TM	SKF	FU 0112-1	FY 2-7/16 WM	SKF	FU 0422-2
FG16205.014	FAG	FU 0064-3	FX3-S224E	LINK BELT	FU 0232-4	FY 1-1/16 WM	SKF	FU 0112-2	FY 3/4 FM	SKF	FU 0037-3
FG16205.100	FAG	FU 0100-3	FX3-S2E20E	LINK BELT	FU 0171-4	FY 1-1/2 FM	SKF	FU 0228-3	FY 3/4 TM	SKF	FU 0037-1
FG16206	FAG	FU 0134-3	FX3-U212N	LINK BELT	FU 0041-1	FY 1-1/2 TM	SKF	FU 0228-1	FY 3/4 WM	SKF	FU 0037-2
FG16206.101	FAG	FU 0112-3	FX3-U214N	LINK BELT	FU 0070-1	FY 1-1/2 WM	SKF	FU 0228-2	FY 30 FM	SKF	FU 0134-3
FG16206.102	FAG	FU 0123-3	FX3-U215N	LINK BELT	FU 0081-1	FY 1-1/4 AFM	SKF	FU 0159-3	FY 30 TM	SKF	FU 0134-1
FG16206.103	FAG	FU 0148-3	FX3-U216N	LINK BELT	FU 0106-1	FY 1-1/4 ATM	SKF	FU 0159-1	FY 30 WM	SKF	FU 0134-2
FG16206.104	FAG	FU 0159-3	FX3-U218N	LINK BELT	FU 0129-1	FY 1-1/4 AWM	SKF	FU 0159-2	FY 3-1/2 TM	SKF	FU 0554-1
FG16207	FAG	FU 0202-3	FX3-U219N	LINK BELT	FU 0154-1	FY 1-1/4 FM	SKF	FU 0162-3	FY 35 FM	SKF	FU 0202-3
FG16207.106	FAG	FU 0191-3	FX3-U220N	LINK BELT	FU 0173-1	FY 1-1/4 TM	SKF	FU 0162-1	FY 35 TM	SKF	FU 0202-1
FG16208	FAG	FU 0237-3	FX3-U222N	LINK BELT	FU 0197-1	FY 1-1/4 WM	SKF	FU 0162-2	FY 35 WM	SKF	FU 0202-2
FG16208.108	FAG	FU 0216-3	FX3-U223N	LINK BELT	FU 0222-1	FY 1-1/8 FM	SKF	FU 0123-3	FY 40 FM	SKF	FU 0246-3
FG16209	FAG	FU 0275-3	FX3-U224N	LINK BELT	FU 0232-1	FY 1-1/8 TM	SKF	FU 0123-1	FY 40 TM	SKF	FU 0246-1
FG16209.112	FAG	FU 0266-3	FX3-U226N	LINK BELT	FU 0262-1	FY 1-1/8 WM	SKF	FU 0123-2	FY 40 WM	SKF	FU 0246-2
FG16210	FAG	FU 0314-3	FX3-U227N	LINK BELT	FU 0271-1	FY 1-11/16 FM	SKF	FU 0266-3	FY 45 FM	SKF	FU 0284-3
FG56204	FAG	FU 0044-1	FX3-U228N	LINK BELT	FU 0280-1	FY 1-11/16 TM	SKF	FU 0266-1	FY 45 TM	SKF	FU 0284-1
FG56204.012	FAG	FU 0037-1	FX3-U231N	LINK BELT	FU 0318-1	FY 1-11/16 WM	SKF	FU 0266-2	FY 45 WM	SKF	FU 0284-2
FG56205	FAG	FU 0086-1	FX3-U232N	LINK BELT	FU 0345-1	FY 1-15/16 FM	SKF	FU 0314-3	FY 50 FM	SKF	FU 0323-3
FG56205.100	FAG	FU 0100-1	FX3-U235N	LINK BELT	FU 0383-1	FY 1-15/16 TM	SKF	FU 0314-1	FY 50 TM	SKF	FU 0323-1
FG56206	FAG	FU 0134-1	FX3-U2E20N	LINK BELT	FU 0171-1	FY 1-15/16 WM	SKF	FU 0314-2	FY 50 WM	SKF	FU 0323-2
FG56206.102	FAG	FU 0123-1	FX3-U2E32N	LINK BELT	FU 0343-1	FY 13/16 FM	SKF	FU 0053-3	FY 55 FM	SKF	FU 0368-3
FG56206.103	FAG	FU 0148-1	FX3-U2M20N	LINK BELT	FU 0049-1	FY 1-3/16 FM	SKF	FU 0148-3	FY 55 TM	SKF	FU 0368-1
FG56207	FAG	FU 0202-1	FX3-U2M25N	LINK BELT	FU 0093-1	FY 13/16 TM	SKF	FU 0053-1	FY 55 WM	SKF	FU 0368-2
FG56207.104	FAG	FU 0162-1	FX3-U2M30N	LINK BELT	FU 0142-1	FY 1-3/16 TM	SKF	FU 0148-1	FY 60 TM	SKF	FU 0403-1
FG56207.106	FAG	FU 0191-1	FX3-U2M35N	LINK BELT	FU 0210-1	FY 13/16 WM	SKF	FU 0053-2	FY 60 WM	SKF	FU 0403-2
FG56207.107	FAG	FU 0216-1	FX3-U2M40N	LINK BELT	FU 0252-1	FY 1-3/16 WM	SKF	FU 0148-2	FY 65 TM	SKF	FU 0438-1
FG56208	FAG	FU 0246-1	FX3-U2M45N	LINK BELT	FU 0291-1	FY 1-3/4 FM	SKF	FU 0275-3	FY 7/8 FM	SKF	FU 0064-3
FG56208.108	FAG	FU 0228-1	FX3-U2M50N	LINK BELT	FU 0329-1	FY 1-3/4 TM	SKF	FU 0275-1	FY 7/8 TM	SKF	FU 0064-1
FG56209	FAG	FU 0284-1	FX3-U2M55N	LINK BELT	FU 0374-1	FY 1-3/4 WM	SKF	FU 0275-2	FY 7/8 WM	SKF	FU 0064-2
FG56209.112	FAG	FU 0275-1	FX3-W212U	LINK BELT	FU 0041-3	FY 1-3/8 FM	SKF	FU 0191-3	FY 70 TM	SKF	FU 0478-1
FG56210	FAG	FU 0323-1	FX3-W214U	LINK BELT	FU 0070-3	FY 1-3/8 TM	SKF	FU 0191-1	FY 75 TM	SKF	FU 0508-1
FG56210.115	FAG	FU 0314-1	FX3-W215U	LINK BELT	FU 0081-3	FY 1-3/8 WM	SKF	FU 0191-2	FY 80 TM	SKF	FU 0533-1
FG56211	FAG	FU 0368-1	FX3-W216U	LINK BELT	FU 0106-3	FY 15/16 FM	SKF	FU 0075-3	FY 90 TM	SKF	FU 0557-1
FG56211.200	FAG	FU 0336-1	FX3-W218E	LINK BELT	FU 0129-3	FY 1-5/16 FM	SKF	FU 0180-3	FYM 1-1/2 TM	SKF	FU 0229-1
FG56211.203	FAG	FU 0379-1	FX3-W219E	LINK BELT	FU 0154-3	FY 15/16 TM	SKF	FU 0075-1	FYM 1-11/16 TM	SKF	FU 0267-1
FG56212	FAG	FU 0403-1	FX3-W220E	LINK BELT	FU 0173-3	FY 1-5/16 TM	SKF	FU 0180-1	FYM 1-15/16 TM	SKF	FU 0315-1
FG56212.204	FAG	FU 0387-1	FX3-W222E	LINK BELT	FU 0197-3	FY 15/16 WM	SKF	FU 0075-2	FYM 1-3/4 TM	SKF	FU 0276-1
FG56212.207	FAG	FU 0422-1	FX3-W223E	LINK BELT	FU 0222-3	FY 1-5/16 WM	SKF	FU 0180-2	FYM 1-7/16 TM	SKF	FU 0220-1
FT 1 FM	SKF	FU 0102-1	FX3-W224E	LINK BELT	FU 0232-3	FY 1-5/8 FM	SKF	FU 0257-3	FYM 2-1/2 TM	SKF	FU 0431-1
FT 1/2 FM	SKF	FU 0007-1	FX3-W226U	LINK BELT	FU 0262-3	FY 1-5/8 TM	SKF	FU 0257-1	FYM 2-11/16 TM	SKF	FU 0463-1
FT 11/16 FM	SKF	FU 0032-1	FX3-W227U	LINK BELT	FU 0271-3	FY 1-5/8 WM	SKF	FU 0257-2	FYM 2-15/16 TM	SKF	FU 0500-1
FT 1-1/16 FM	SKF	FU 0114-1	FX3-W228U	LINK BELT	FU 0280-3	FY 1-7/16 FM	SKF	FU 0216-3	FYM 2-3/16 TM	SKF	FU 0381-1
FT 1-1/4 AFM	SKF	FU 0161-1	FX3-W231U	LINK BELT	FU 0318-3	FY 1-7/16 TM	SKF	FU 0216-1	FYM 3 TM	SKF	FU 0514-1

BY PART NUMBER

BY PART NUMBER

Part No.	Brand	Group No.	Part No.	Brand	Group No.	Part No.	Brand	Group No.	Part No.	Brand	Group No.
FYT 1 FM	SKF	FU 0107-3	FYT 3/4 TM	SKF	FU 0042-1	GARAF 103 MBA	KOYO	FU 0143-3	KHPF 207-21 AE	NACHI	FU 0181-1
FYT 1 TM	SKF	FU 0107-1	FYT 3/4 WM	SKF	FU 0042-2	GARAF 104 BA	KOYO	FU 0174-3	KHPF 207-22 AE	NACHI	FU 0192-1
FYT 1 WM	SKF	FU 0107-2	FYT 30 FM	SKF	FU 0143-3	GARAF 105 BA	KOYO	FU 0187-3	KHPF 207-23 AE	NACHI	FU 0217-1
FYT 1-1/16 FM	SKF	FU 0119-3	FYT 30 TM	SKF	FU 0143-1	GARAF 106 BA	KOYO	FU 0198-3	KHPFL 201 AE	NACHI	FU 0002-1
FYT 1-1/16 TM	SKF	FU 0119-1	FYT 30 WM	SKF	FU 0143-2	GARAF 106 MBA	KOYO	FU 0211-3	KHPFL 201-8 AE	NACHI	FU 0007-1
FYT 1-1/16 WM	SKF	FU 0119-2	FYT 35 FM	SKF	FU 0211-3	GARAF 107 BA	KOYO	FU 0223-3	KHPFL 202 AE	NACHI	FU 0017-1
FYT 1-1/2 FM	SKF	FU 0233-3	FYT 35 TM	SKF	FU 0211-1	GARAF 108 BA	KOYO	FU 0233-3	KHPFL 202-10 AE	NACHI	FU 0022-1
FYT 1-1/2 TM	SKF	FU 0233-1	FYT 35 WM	SKF	FU 0211-2	GARAF 109 BA	KOYO	FU 0242-3	KHPFL 202-9 AE	NACHI	FU 0012-1
FYT 1-1/2 WM	SKF	FU 0233-2	FYT 40 FM	SKF	FU 0253-3	GARAF 109 MBA	KOYO	FU 0253-3	KHPFL 203 AE	NACHI	FU 0027-1
FYT 1-1/4 AFM	SKF	FU 0172-3	FYT 40 TM	SKF	FU 0253-1	GARAF 110 BA	KOYO	FU 0261-3	KHPFL 203-11 AE	NACHI	FU 0032-1
FYT 1-1/4 ATM	SKF	FU 0172-1	FYT 40 WM	SKF	FU 0253-2	GARAF 111 BA	KOYO	FU 0270-3	KHPFL 204 AE	NACHI	FU 0047-1
FYT 1-1/4 AWM	SKF	FU 0172-2	FYT 45 FM	SKF	FU 0290-3	GARAF 112 BA	KOYO	FU 0279-3	KHPFL 204-12 AE	NACHI	FU 0039-1
FYT 1-1/4 FM	SKF	FU 0174-3	FYT 45 TM	SKF	FU 0290-1	GARAF 112 MBA	KOYO	FU 0290-3	KHPFL 205 AE	NACHI	FU 0088-1
FYT 1-1/4 TM	SKF	FU 0174-1	FYT 45 WM	SKF	FU 0290-2	GARAF 114 A	KOYO	FU 0310-3	KHPFL 205-14 AE	NACHI	FU 0066-1
FYT 1-1/4 WM	SKF	FU 0174-2	FYT 50 FM	SKF	FU 0330-3	GARAF 115 A	KOYO	FU 0319-3	KHPFL 205-15 AE	NACHI	FU 0077-1
FYT 1-1/8 FM	SKF	FU 0130-3	FYT 50 TM	SKF	FU 0330-1	GARAF 115 MA	KOYO	FU 0330-3	KHPFL 205-16 AE	NACHI	FU 0102-1
FYT 1-1/8 TM	SKF	FU 0130-1	FYT 50 WM	SKF	FU 0330-2	GFF 1012 B	KOYO	FU 0037-2	KHPFL 206 AE	NACHI	FU 0136-1
FYT 1-1/8 WM	SKF	FU 0130-2	FYT 55 FM	SKF	FU 0375-3	GFF 1012 MB	KOYO	FU 0044-2	KHPFL 206-18 AE	NACHI	FU 0125-1
FYT 1-11/16 FM	SKF	FU 0270-3	FYT 55 TM	SKF	FU 0375-1	GFF 1013 B	KOYO	FU 0053-2	KHPFL 206-19 AE	NACHI	FU 0150-1
FYT 1-11/16 TM	SKF	FU 0270-1	FYT 55 WM	SKF	FU 0375-2	GFF 1014 B	KOYO	FU 0064-2	KHPFL 206-20 AE	NACHI	FU 0161-1
FYT 1-11/16 WM	SKF	FU 0270-2	FYT 7/8 FM	SKF	FU 0071-3	GFF 1015 B	KOYO	FU 0075-2	KHPFL 207 AE	NACHI	FU 0204-1
FYT 1-15/16 FM	SKF	FU 0319-3	FYT 7/8 TM	SKF	FU 0071-1	GFF 1100 B	KOYO	FU 0100-2	KHPFL 207-20 AE	NACHI	FU 0166-1
FYT 1-15/16 TM	SKF	FU 0319-1	FYT 7/8 WM	SKF	FU 0071-2	GFF 1100 MB	KOYO	FU 0086-2	KHPFL 207-21 AE	NACHI	FU 0182-1
FYT 1-15/16 WM	SKF	FU 0319-2	FYTM 1-1/2 TM	SKF	FU 0234-1	GFF 1102 B	KOYO	FU 0123-2	KHPFL 207-22 AE	NACHI	FU 0193-1
FYT 13/16 FM	SKF	FU 0060-3	FYTM 1-11/16 TM	SKF	FU 0272-1	GFF 1103 B	KOYO	FU 0148-2	KHPFL 207-23 AE	NACHI	FU 0218-1
FYT 1-3/16 FM	SKF	FU 0155-3	FYTM 1-15/16 TM	SKF	FU 0320-1	GFF 1103 MB	KOYO	FU 0134-2	MSF1	RHP	FU 0104-1
FYT 13/16 TM	SKF	FU 0060-1	FYTM 1-3/4 TM	SKF	FU 0281-1	GFF 1104 B	KOYO	FU 0162-2	MSF1	SNR	FU 0104-1
FYT 1-3/16 TM	SKF	FU 0155-1	FYTM 1-7/16 TM	SKF	FU 0225-1	GFF 1104 B-1	KOYO	FU 0159-2	MSF1 1/2	RHP	FU 0229-1
FYT 13/16 WM	SKF	FU 0060-2	GARAF 012 A	KOYO	FU 0037-3	GFF 1105 B	KOYO	FU 0180-2	MSF1 1/2	SNR	FU 0229-1
FYT 1-3/16 WM	SKF	FU 0155-2	GARAF 012 MA	KOYO	FU 0044-3	GFF 1106 B	KOYO	FU 0191-2	MSF1 1/4	RHP	FU 0163-1
FYT 1-3/4 FM	SKF	FU 0279-3	GARAF 013 A	KOYO	FU 0053-3	GFF 1106 MB	KOYO	FU 0202-2	MSF1 3/4	SNR	FU 0163-1
FYT 1-3/4 TM	SKF	FU 0279-1	GARAF 014 A	KOYO	FU 0064-3	GFF 1107 B	KOYO	FU 0216-2	MSF1 11/16	RHP	FU 0267-1
FYT 1-3/4 WM	SKF	FU 0279-2	GARAF 015 A	KOYO	FU 0075-3	GFFL 1012 B	KOYO	FU 0042-2	MSF1 11/16	SNR	FU 0267-1
FYT 1-3/8 FM	SKF	FU 0198-3	GARAF 100 A	KOYO	FU 0100-3	GFFL 1012 MB	KOYO	FU 0050-2	MSF1 15/16	RHP	FU 0315-1
FYT 1-3/8 TM	SKF	FU 0198-1	GARAF 100 MA	KOYO	FU 0086-3	GFFL 1013 B	KOYO	FU 0060-2	MSF1 15/16	SNR	FU 0315-1
FYT 1-3/8 WM	SKF	FU 0198-2	GARAF 102 A	KOYO	FU 0123-3	GFFL 1014 B	KOYO	FU 0071-2	MSF1 3/16	RHP	FU 0151-1
FYT 15/16 FM	SKF	FU 0082-3	GARAF 103 A	KOYO	FU 0148-3	GFFL 1015 B	KOYO	FU 0082-2	MSF1 3/16	SNR	FU 0151-1
FYT 1-5/16 FM	SKF	FU 0187-3	GARAF 103 MA	KOYO	FU 0134-3	GFFL 1100 B	KOYO	FU 0107-2	MSF1 3/4	RHP	FU 0276-1
FYT 15/16 TM	SKF	FU 0082-1	GARAF 104 A	KOYO	FU 0162-3	GFFL 1100 MB	KOYO	FU 0094-2	MSF1 3/4	SNR	FU 0276-1
FYT 1-5/16 TM	SKF	FU 0187-1	GARAF 104 A-1	KOYO	FU 0159-3	GFFL 1102 B	KOYO	FU 0130-2	MSF1 3/8	RHP	FU 0195-1
FYT 15/16 WM	SKF	FU 0082-2	GARAF 105 A	KOYO	FU 0180-3	GFFL 1103 B	KOYO	FU 0155-2	MSF1 3/8	SNR	FU 0195-1
FYT 1-5/16 WM	SKF	FU 0187-2	GARAF 106 A	KOYO	FU 0191-3	GFFL 1103 B-1	KOYO	FU 0172-2	MSF1 7/16	RHP	FU 0220-1
FYT 1-5/8 FM	SKF	FU 0261-3	GARAF 106 MA	KOYO	FU 0202-3	GFFL 1103 MB	KOYO	FU 0143-2	MSF1 7/16	SNR	FU 0220-1
FYT 1-5/8 TM	SKF	FU 0261-1	GARAF 107 A	KOYO	FU 0216-3	GFFL 1104 B	KOYO	FU 0174-2	MSF1 7/8	RHP	FU 0306-1
FYT 1-5/8 WM	SKF	FU 0261-2	GARAF 108 A	KOYO	FU 0228-3	GFFL 1105 B	KOYO	FU 0187-2	MSF1 7/8	SNR	FU 0306-1
FYT 1-7/16 FM	SKF	FU 0223-3	GARAF 109 A	KOYO	FU 0237-3	GFFL 1106 B	KOYO	FU 0198-2	MSF-15	SEALMASTER	FU 0079-1
FYT 1-7/16 TM	SKF	FU 0223-1	GARAF 109 MBA	KOYO	FU 0246-3	GFFL 1106 MB	KOYO	FU 0211-2	MSF-16	SEALMASTER	FU 0104-1
FYT 1-7/16 WM	SKF	FU 0223-2	GARAF 110 A	KOYO	FU 0257-3	GFFL 1107 B	KOYO	FU 0223-2	MSF-19	SEALMASTER	FU 0151-1
FYT 1-7/8 FM	SKF	FU 0310-3	GARAF 111 A	KOYO	FU 0266-3	KHPF 201 AE	NACHI	FU 0001-1	MSF2	RHP	FU 0337-1
FYT 1-7/8 TM	SKF	FU 0310-1	GARAF 112 A	KOYO	FU 0275-3	KHPF 201-8 AE	NACHI	FU 0006-1	MSF2	SNR	FU 0337-1
FYT 1-7/8 WM	SKF	FU 0310-2	GARAF 112 MA	KOYO	FU 0284-3	KHPF 202 AE	NACHI	FU 0016-1	MSF2 1/2	RHP	FU 0431-1
FYT 1-9/16 FM	SKF	FU 0242-3	GARAF 114 A	KOYO	FU 0305-3	KHPF 202-10 AE	NACHI	FU 0021-1	MSF2 1/2	SNR	FU 0431-1
FYT 1-9/16 TM	SKF	FU 0242-1	GARAF 115 A	KOYO	FU 0314-3	KHPF 202-9 AE	NACHI	FU 0011-1	MSF2 1/4	RHP	FU 0388-1
FYT 1-9/16 WM	SKF	FU 0242-2	GARAF 115 MA	KOYO	FU 0323-3	KHPF 203 AE	NACHI	FU 0026-1	MSF2 1/4	SNR	FU 0388-1
FYT 2 FM	SKF	FU 0346-3	GARAF 200 A	KOYO	FU 0336-3	KHPF 203-11 AE	NACHI	FU 0031-1	MSF2 11/16	RHP	FU 0463-1
FYT 2 TM	SKF	FU 0346-1	GARAF 203 A	KOYO	FU 0379-3	KHPF 204 AE	NACHI	FU 0046-1	MSF2 11/16	SNR	FU 0463-1
FYT 2 WM	SKF	FU 0346-2	GARAF 203 MA	KOYO	FU 0368-3	KHPF 204-12 AE	NACHI	FU 0038-1	MSF2 15/16	RHP	FU 0500-1
FYT 20 FM	SKF	FU 0050-3	GARAF 012 A	KOYO	FU 0042-3	KHPF 205 AE	NACHI	FU 0087-1	MSF2 15/16	SNR	FU 0500-1
FYT 20 TM	SKF	FU 0050-1	GARAF 012 MA	KOYO	FU 0050-3	KHPF 205-14 AE	NACHI	FU 0065-1	MSF2 3/16	RHP	FU 0381-1
FYT 20 WM	SKF	FU 0050-2	GARAF 013 BA	KOYO	FU 0060-3	KHPF 205-15 AE	NACHI	FU 0076-1	MSF2 3/16	SNR	FU 0381-1
FYT 2-3/16 FM	SKF	FU 0384-3	GARAF 014 BA	KOYO	FU 0071-3	KHPF 205-16 AE	NACHI	FU 0101-1	MSF2 3/4	RHP	FU 0471-1
FYT 2-3/16 TM	SKF	FU 0384-1	GARAF 015 BA	KOYO	FU 0082-3	KHPF 206 AE	NACHI	FU 0135-1	MSF2 3/4	SNR	FU 0471-1
FYT 2-3/16 WM	SKF	FU 0384-2	GARAF 100 BA	KOYO	FU 0107-3	KHPF 206-18 AE	NACHI	FU 0124-1	MSF2 7/16	RHP	FU 0423-1
FYT 25 FM	SKF	FU 0094-3	GARAF 100 MBA	KOYO	FU 0094-3	KHPF 206-19 AE	NACHI	FU 0149-1	MSF2 7/16	SNR	FU 0423-1
FYT 25 TM	SKF	FU 0094-1	GARAF 102 BA	KOYO	FU 0130-3	KHPF 206-20 AE	NACHI	FU 0160-1	MSF-20	SEALMASTER	FU 0163-1
FYT 25 WM	SKF	FU 0094-2	GARAF 103 BA	KOYO	FU 0155-3	KHPF 207 AE	NACHI	FU 0203-1	MSF-23	SEALMASTER	FU 0220-1
FYT 3/4 FM	SKF	FU 0042-3	GARAF 103 BA-1	KOYO	FU 0172-3	KHPF 207-20 AE	NACHI	FU 0165-1	MSF-24	SEALMASTER	FU 0229-1

BY PART NUMBER

Part No.	Brand	Group No.	Part No.	Brand	Group No.	Part No.	Brand	Group No.	Part No.	Brand	Group No.
MSF25	RHP	FU 0090-1	MSFT30	RHP	FU 0145-1	PCJTY 25	INA	FU 0094-4	RA-1/2	FAFNIR	FU 0006-1
MSF25	SNR	FU 0090-1	MSFT-305	SEALMASTER	FU 0098-1	PCJTY 30	INA	FU 0143-4	RA-1-1/16	FAFNIR	FU 0113-1
MSF-27	SEALMASTER	FU 0267-1	MSFT-306	SEALMASTER	FU 0145-1	PCJTY 35	INA	FU 0211-4	RA-1-1/4	FAFNIR	FU 0165-1
MSF-28	SEALMASTER	FU 0276-1	MSFT-307	SEALMASTER	FU 0214-1	PCJTY 40	INA	FU 0253-4	RA-1-1/4S	FAFNIR	FU 0160-1
MSF3	RHP	FU 0514-1	MSFT-308	SEALMASTER	FU 0255-1	PCJY	INA	FU 0216-4	RA-1-1/8	FAFNIR	FU 0124-1
MSF3	SNR	FU 0514-1	MSFT-309	SEALMASTER	FU 0293-1	PCJY 20	INA	FU 0044-4	RA-13/16	FAFNIR	FU 0054-1
MSF30	RHP	FU 0138-1	MSFT-31	SEALMASTER	FU 0320-1	PCJY 25	INA	FU 0086-4	RA-1-3/16	FAFNIR	FU 0149-1
MSF30	SNR	FU 0138-1	MSFT-310	SEALMASTER	FU 0332-1	PCJY 30	INA	FU 0134-4	RA-1-3/8	FAFNIR	FU 0192-1
MSF-305	SEALMASTER	FU 0090-1	MSFT-32	SEALMASTER	FU 0347-1	PCJY 35	INA	FU 0202-4	RA-15/16	FAFNIR	FU 0076-1
MSF-306	SEALMASTER	FU 0138-1	MSFT35	RHP	FU 0214-1	PCJY 40	INA	FU 0246-4	RA-1-5/16	FAFNIR	FU 0181-1
MSF-307	SEALMASTER	FU 0206-1	MSFT40	RHP	FU 0255-1	PF 012 A	KOYO	FU 0038-1	RA-17	FAFNIR	FU 0026-1
MSF-308	SEALMASTER	FU 0248-1	MSFT45	RHP	FU 0293-1	PF 012 MA	KOYO	FU 0046-1	RA-1-7/16	FAFNIR	FU 0217-1
MSF-309	SEALMASTER	FU 0286-1	MSFT50	RHP	FU 0332-1	PF 013 A	KOYO	FU 0054-1	RA-20	FAFNIR	FU 0046-1
MSF-31	SEALMASTER	FU 0315-1	PBF 16 MJ	KOYO	FU 0086-4	PF 014 A	KOYO	FU 0065-1	RA-25	FAFNIR	FU 0087-1
MSF-310	SEALMASTER	FU 0325-1	PBF 19 MJ	KOYO	FU 0134-4	PF 015 A	KOYO	FU 0076-1	RA-3/4	FAFNIR	FU 0038-1
MSF-311	SEALMASTER	FU 0371-1	PBF 22 MJ	KOYO	FU 0202-4	PF 100 A	KOYO	FU 0101-1	RA-30	FAFNIR	FU 0135-1
MSF-313	SEALMASTER	FU 0439-1	PBF 25 MJ	KOYO	FU 0246-4	PF 100 MA	KOYO	FU 0087-1	RA-35	FAFNIR	FU 0203-1
MSF-314	SEALMASTER	FU 0479-1	PBFL 16 MJ	KOYO	FU 0094-4	PF 102 A	KOYO	FU 0124-1	RA-5/8	FAFNIR	FU 0021-1
MSF-315	SEALMASTER	FU 0507-1	PBFL 19 MJ	KOYO	FU 0143-4	PF 103 A	KOYO	FU 0149-1	RA-7/8	FAFNIR	FU 0065-1
MSF-32	SEALMASTER	FU 0337-1	PBFL 22 MJ	KOYO	FU 0211-4	PF 103 MA	KOYO	FU 0135-1	RA-9/16	FAFNIR	FU 0011-1
MSF35	RHP	FU 0206-1	PBFL 25 MJ	KOYO	FU 0253-4	PF 104 A	KOYO	FU 0165-1	RAT 1 1/16"	INA	FU 0114-1
MSF35	SNR	FU 0206-1	PCJ 1 1/16"	INA	FU 0112-3	PF 104 A-1	KOYO	FU 0160-1	RAT 1 1/4"	INA	FU 0166-1
MSF-35	SEALMASTER	FU 0381-1	PCJ 1 1/2"	INA	FU 0228-3	PF 105 A	KOYO	FU 0181-1	RAT 1 1/4"-206	INA	FU 0161-1
MSF-36	SEALMASTER	FU 0388-1	PCJ 1 1/4"	INA	FU 0162-3	PF 106 A	KOYO	FU 0192-1	RAT 1 1/8"	INA	FU 0125-1
MSF-39	SEALMASTER	FU 0423-1	PCJ 1 1/4"-206	INA	FU 0159-3	PF 106 MA	KOYO	FU 0203-1	RAT 1 3/16"	INA	FU 0150-1
MSF40	RHP	FU 0248-1	PCJ 1 1/8"	INA	FU 0123-3	PF 107 A	KOYO	FU 0217-1	RAT 1 3/8"	INA	FU 0193-1
MSF40	SNR	FU 0248-1	PCJ 1 15/16"	INA	FU 0314-3	PME 20	INA	FU 0048-3	RAT 1 7/16"	INA	FU 0218-1
MSF-40	SEALMASTER	FU 0431-1	PCJ 1 3/16"	INA	FU 0148-3	PME 25	INA	FU 0092-3	RAT 1"	INA	FU 0102-1
MSF-43	SEALMASTER	FU 0463-1	PCJ 1 3/4"	INA	FU 0275-3	PME 30	INA	FU 0140-3	RAT 1/2"	INA	FU 0007-1
MSF45	RHP	FU 0286-1	PCJ 1 3/8"	INA	FU 0191-3	PME 35	INA	FU 0208-3	RAT 12	INA	FU 0002-1
MSF45	SNR	FU 0286-1	PCJ 1 7/16"	INA	FU 0216-3	PME 40	INA	FU 0250-3	RAT 15	INA	FU 0017-1
MSF-47	SEALMASTER	FU 0500-1	PCJ 1"	INA	FU 0100-3	PME 45	INA	FU 0288-3	RAT 17	INA	FU 0027-1
MSF-48	SEALMASTER	FU 0514-1	PCJ 2 3/16"	INA	FU 0379-3	PME 50	INA	FU 0327-3	RAT 20	INA	FU 0047-1
MSF50	RHP	FU 0325-1	PCJ 2"	INA	FU 0336-3	PME 55	INA	FU 0372-3	RAT 25	INA	FU 0088-1
MSF50	SNR	FU 0325-1	PCJ 20	INA	FU 0044-3	PTF 010 A	KOYO	FU 0022-1	RAT 3/4"	INA	FU 0039-1
MSF55	RHP	FU 0371-1	PCJ 25	INA	FU 0086-3	PTF 011 MA	KOYO	FU 0027-1	RAT 30	INA	FU 0136-1
MSF55	SNR	FU 0371-1	PCJ 3/4"	INA	FU 0037-3	PTF 012 A	KOYO	FU 0039-1	RAT 35	INA	FU 0204-1
MSF60	RHP	FU 0405-1	PCJ 30	INA	FU 0134-3	PTF 012 MA	KOYO	FU 0047-1	RAT 5/8"	INA	FU 0022-1
MSF60	SNR	FU 0405-1	PCJ 35	INA	FU 0202-3	PTF 013 A	KOYO	FU 0055-1	RAT 7/8"	INA	FU 0066-1
MSF65	RHP	FU 0439-1	PCJ 40	INA	FU 0246-3	PTF 014 A	KOYO	FU 0066-1	RAT-1	FAFNIR	FU 0102-1
MSF65	SNR	FU 0439-1	PCJ 45	INA	FU 0284-3	PTF 015 A	KOYO	FU 0077-1	RAT-1/2	FAFNIR	FU 0007-1
MSF70	RHP	FU 0479-1	PCJ 50	INA	FU 0323-3	PTF 100 A	KOYO	FU 0102-1	RAT-1-1/16	FAFNIR	FU 0114-1
MSF70	SNR	FU 0479-1	PCJ 55	INA	FU 0368-3	PTF 100 MA	KOYO	FU 0088-1	RAT-1-1/4S	FAFNIR	FU 0161-1
MSF75	RHP	FU 0507-1	PCJ 7/8"	INA	FU 0064-3	PTF 102 A	KOYO	FU 0125-1	RAT-1-1/4S	FAFNIR	FU 0166-1
MSF75	SNR	FU 0507-1	PCJTY 1 1/16"	INA	FU 0119-3	PTF 103 A	KOYO	FU 0150-1	RAT-1-1/8	FAFNIR	FU 0125-1
MSF80	RHP	FU 0534-1	PCJTY 1 1/2"	INA	FU 0233-3	PTF 103 A-1	KOYO	FU 0161-1	RAT-1-3/16	FAFNIR	FU 0150-1
MSF80	SNR	FU 0534-1	PCJTY 1 1/4"	INA	FU 0174-3	PTF 103 MA	KOYO	FU 0136-1	RAT-1-3/8	FAFNIR	FU 0193-1
MSFT1	RHP	FU 0109-1	PCJTY 1 1/4"-206	INA	FU 0172-3	RA 1 1/16"	INA	FU 0113-1	RAT-15/16	FAFNIR	FU 0077-1
MSFT1 1/2	RHP	FU 0234-1	PCJTY 1 1/8"	INA	FU 0130-3	RA 1 1/4"	INA	FU 0165-1	RAT-1-5/16	FAFNIR	FU 0182-1
MSFT1 1/4	RHP	FU 0175-1	PCJTY 1 15/16"	INA	FU 0319-3	RA 1 1/4"-206	INA	FU 0160-1	RAT-17	FAFNIR	FU 0027-1
MSFT1 11/16	RHP	FU 0272-1	PCJTY 1 3/16"	INA	FU 0155-3	RA 1 1/8"	INA	FU 0124-1	RAT-1-7/16	FAFNIR	FU 0218-1
MSFT1 15/16	RHP	FU 0320-1	PCJTY 1 3/4"	INA	FU 0279-3	RA 1 3/16"	INA	FU 0149-1	RAT-20	FAFNIR	FU 0047-1
MSFT1 3/16	RHP	FU 0156-1	PCJTY 1 3/8"	INA	FU 0198-3	RA 1 3/8"	INA	FU 0192-1	RAT-25	FAFNIR	FU 0088-1
MSFT1 3/4	RHP	FU 0281-1	PCJTY 1 7/16"	INA	FU 0223-3	RA 1 7/16"	INA	FU 0217-1	RAT-3/4	FAFNIR	FU 0039-1
MSFT1 3/8	RHP	FU 0200-1	PCJTY 1"	INA	FU 0107-3	RA 1"	INA	FU 0101-1	RAT-30	FAFNIR	FU 0136-1
MSFT1 7/16	RHP	FU 0225-1	PCJTY 2"	INA	FU 0346-3	RA 1/2"	INA	FU 0006-1	RAT-35	FAFNIR	FU 0204-1
MSFT1 7/8	RHP	FU 0311-1	PCJTY 20	INA	FU 0050-3	RA 12	INA	FU 0001-1	RAT-5/8	FAFNIR	FU 0022-1
MSFT-15	SEALMASTER	FU 0084-1	PCJTY 25	INA	FU 0094-3	RA 15	INA	FU 0016-1	RAT-7/8	FAFNIR	FU 0066-1
MSFT-16	SEALMASTER	FU 0109-1	PCJTY 3/4"	INA	FU 0042-3	RA 17	INA	FU 0026-1	RATY 1"	INA	FU 0102-2
MSFT-19	SEALMASTER	FU 0156-1	PCJTY 30	INA	FU 0143-3	RA 20	INA	FU 0046-1	RATY 12	INA	FU 0002-2
MSFT2	RHP	FU 0347-1	PCJTY 35	INA	FU 0211-3	RA 25	INA	FU 0087-1	RATY 15	INA	FU 0017-2
MSFT-20	SEALMASTER	FU 0175-1	PCJTY 40	INA	FU 0253-3	RA 30	INA	FU 0038-1	RATY 17	INA	FU 0027-2
MSFT-23	SEALMASTER	FU 0225-1	PCJTY 45	INA	FU 0290-3	RA 30	INA	FU 0135-1	RATY 20	INA	FU 0047-2
MSFT-24	SEALMASTER	FU 0234-1	PCJTY 50	INA	FU 0330-3	RA 35	INA	FU 0203-1	RATY 25	INA	FU 0088-2
MSFT25	RHP	FU 0098-1	PCJTY 55	INA	FU 0375-3	RA 5/8"	INA	FU 0021-1	RATY 30	INA	FU 0136-2
MSFT-27	SEALMASTER	FU 0272-1	PCJTY 7/8"	INA	FU 0071-3	RA 7/8"	INA	FU 0065-1	RATY 35	INA	FU 0204-2
MSFT-28	SEALMASTER	FU 0281-1	PCJTY 20	INA	FU 0050-4	RA-1	FAFNIR	FU 0101-1	RAY 1"	INA	FU 0101-2

BY PART NUMBER

Part No.	Brand	Group No.	Part No.	Brand	Group No.	Part No.	Brand	Group No.	Part No.	Brand	Group No.
RAY 12	INA	FU 0001-2	RCJ-2-7/16	FAFNIR	FU 0429-2	RCJT-2-3/16	FAFNIR	FU 0384-2	RCJY 45-MP	INA	FU 0286-1
RAY 15	INA	FU 0016-2	RCJ-3/4	FAFNIR	FU 0036-2	RCJT-25	FAFNIR	FU 0094-2	RCJY 5/8"	INA	FU 0023-1
RAY 17	INA	FU 0026-2	RCJ-30	FAFNIR	FU 0133-2	RCJT-3/4	FAFNIR	FU 0042-2	RCJY 50	INA	FU 0323-1
RAY 20	INA	FU 0046-2	RCJ-35	FAFNIR	FU 0215-2	RCJT-30	FAFNIR	FU 0143-2	RCJY 50-MP	INA	FU 0325-1
RAY 25	INA	FU 0087-2	RCJ-40	FAFNIR	FU 0245-2	RCJT-35	FAFNIR	FU 0211-2	RCJY 55	INA	FU 0368-1
RAY 30	INA	FU 0135-2	RCJ-45	FAFNIR	FU 0295-2	RCJT-40	FAFNIR	FU 0253-2	RCJY 60	INA	FU 0403-1
RAY 35	INA	FU 0203-2	RCJ-50	FAFNIR	FU 0334-2	RCJT-45	FAFNIR	FU 0290-2	RCJY 60-MP	INA	FU 0405-1
RCJ 1 1/2"	INA	FU 0228-2	RCJ-55	FAFNIR	FU 0378-2	RCJT-50	FAFNIR	FU 0330-2	RCJY 65-213	INA	FU 0438-1
RCJ 1 1/4"	INA	FU 0162-2	RCJ-60	FAFNIR	FU 0413-2	RCJT-55	FAFNIR	FU 0375-2	RCJY 7/8"	INA	FU 0064-1
RCJ 1 1/4"-206	INA	FU 0159-2	RCJ-7/8	FAFNIR	FU 0074-2	RCJT-7/8	FAFNIR	FU 0071-2	RCJY 70	INA	FU 0478-1
RCJ 1 1/8"	INA	FU 0123-2	RCJ-75	FAFNIR	FU 0513-2	RCJTY 1 1/2"	INA	FU 0233-1	RCJY 75	INA	FU 0508-1
RCJ 1 11/16"	INA	FU 0266-2	RCJOY 30	INA	FU 0139-1	RCJTY 1 1/4"	INA	FU 0174-1	RCJY 80	INA	FU 0533-1
RCJ 1 15/16"	INA	FU 0314-2	RCJOY 40	INA	FU 0249-1	RCJTY 1 1/4"-206	INA	FU 0172-1	RCJY 90	INA	FU 0557-1
RCJ 1 3/16"	INA	FU 0148-2	RCJOY 50	INA	FU 0326-1	RCJTY 1 1/8"	INA	FU 0130-1	RME 15	INA	FU 0019-2
RCJ 1 3/4"	INA	FU 0275-2	RCJOY 60	INA	FU 0406-1	RCJTY 1 15/16"	INA	FU 0319-1	RME 17	INA	FU 0029-2
RCJ 1 3/8"	INA	FU 0191-2	RCJT 1 1/2"	INA	FU 0233-2	RCJTY 1 3/4"	INA	FU 0279-1	RME 20	INA	FU 0048-2
RCJ 1 5/8"	INA	FU 0257-2	RCJT 1 1/4"	INA	FU 0174-2	RCJTY 1 3/8"	INA	FU 0198-1	RME 25	INA	FU 0092-2
RCJ 1 7/16"	INA	FU 0216-2	RCJT 1 1/4"-206	INA	FU 0172-2	RCJTY 1"	INA	FU 0107-1	RME 30	INA	FU 0140-2
RCJ 1"	INA	FU 0100-2	RCJT 1 1/8"	INA	FU 0130-2	RCJTY 1/2"	INA	FU 0010-1	RME 35	INA	FU 0208-2
RCJ 15	INA	FU 0018-2	RCJT 1 11/16"	INA	FU 0270-2	RCJTY 12	INA	FU 0005-1	RME 40	INA	FU 0250-2
RCJ 15/16"	INA	FU 0075-2	RCJT 1 15/16"	INA	FU 0319-2	RCJTY 15	INA	FU 0020-1	RME 45	INA	FU 0288-2
RCJ 17	INA	FU 0028-2	RCJT 1 3/16"	INA	FU 0155-2	RCJTY 17	INA	FU 0030-1	RME 50	INA	FU 0327-2
RCJ 2 15/16" S	INA	FU 0501-2	RCJT 1 3/4"	INA	FU 0279-2	RCJTY 15 1/16"	INA	FU 0504-1	RME 55	INA	FU 0372-2
RCJ 2 3/16"	INA	FU 0379-2	RCJT 1 3/8"	INA	FU 0198-2	RCJTY 2 7/16"	INA	FU 0427-1	RME 60	INA	FU 0407-2
RCJ 2 7/16"	INA	FU 0422-2	RCJT 1 5/8"	INA	FU 0261-2	RCJTY 2"	INA	FU 0346-1	RME 70 S	INA	FU 0480-2
RCJ 20	INA	FU 0044-2	RCJT 1 7/16"	INA	FU 0223-2	RCJTY 20	INA	FU 0050-1	RME 75 S	INA	FU 0509-2
RCJ 25	INA	FU 0086-2	RCJT 1"	INA	FU 0107-2	RCJTY 25	INA	FU 0094-1	RMEY 1 1/2"	INA	FU 0231-1
RCJ 3/4"	INA	FU 0037-2	RCJT 15	INA	FU 0020-2	RCJTY 3/4"	INA	FU 0042-1	RMEY 1 1/4"	INA	FU 0170-1
RCJ 30	INA	FU 0134-2	RCJT 15/16"	INA	FU 0082-2	RCJTY 30	INA	FU 0143-1	RMEY 1 1/4"-206	INA	FU 0167-1
RCJ 35	INA	FU 0202-2	RCJT 17	INA	FU 0030-2	RCJTY 35	INA	FU 0211-1	RMEY 1 1/8"	INA	FU 0128-1
RCJ 40	INA	FU 0246-2	RCJT 2 15/16" S	INA	FU 0504-2	RCJTY 40	INA	FU 0253-1	RMEY 1 15/16"	INA	FU 0317-1
RCJ 45	INA	FU 0284-2	RCJT 2 7/16"	INA	FU 0427-2	RCJTY 45	INA	FU 0290-1	RMEY 1 3/4"	INA	FU 0278-1
RCJ 5/8"	INA	FU 0023-2	RCJT 20	INA	FU 0050-2	RCJTY 5/8"	INA	FU 0025-1	RMEY 1 3/8"	INA	FU 0196-1
RCJ 50	INA	FU 0323-2	RCJT 25	INA	FU 0094-2	RCJTY 50	INA	FU 0330-1	RMEY 1"	INA	FU 0105-1
RCJ 55	INA	FU 0368-2	RCJT 3/4"	INA	FU 0042-2	RCJTY 55	INA	FU 0375-1	RMEY 12	INA	FU 0004-1
RCJ 60	INA	FU 0403-2	RCJT 30	INA	FU 0143-2	RCJTY 60	INA	FU 0410-1	RMEY 15	INA	FU 0019-1
RCJ 7/8"	INA	FU 0064-2	RCJT 35	INA	FU 0211-2	RCJTY 7/8"	INA	FU 0071-1	RMEY 17	INA	FU 0029-1
RCJ 70 S	INA	FU 0478-2	RCJT 40	INA	FU 0253-2	RCJTY 70	INA	FU 0483-1	RMEY 2 1/2"-213	INA	FU 0433-1
RCJ 75 S	INA	FU 0508-2	RCJT 45	INA	FU 0290-2	RCJTY 75	INA	FU 0511-1	RMEY 2 15/16"	INA	FU 0502-1
RCJ-1	FAFNIR	FU 0110-2	RCJT 5/8"	INA	FU 0025-2	RCJY 1 1/2"	INA	FU 0228-1	RMEY 2 7/16"	INA	FU 0425-1
RCJ-1-1/16	FAFNIR	FU 0111-2	RCJT 50	INA	FU 0330-2	RCJY 1 1/2"-MP	INA	FU 0229-1	RMEY 2"	INA	FU 0342-1
RCJ-1-1/2	FAFNIR	FU 0227-2	RCJT 55	INA	FU 0375-2	RCJY 1 1/4"	INA	FU 0162-1	RMEY 20	INA	FU 0048-1
RCJ-1-1/4	FAFNIR	FU 0179-2	RCJT 60	INA	FU 0410-2	RCJY 1 1/4"-206	INA	FU 0159-1	RMEY 25	INA	FU 0092-1
RCJ-1-1/8	FAFNIR	FU 0122-2	RCJT 7/8"	INA	FU 0071-2	RCJY 1 1/8"	INA	FU 0123-1	RMEY 3/4"	INA	FU 0040-1
RCJ-1-11/16	FAFNIR	FU 0274-2	RCJT 70 S	INA	FU 0483-2	RCJY 1 15/16"	INA	FU 0314-1	RMEY 30	INA	FU 0140-1
RCJ-1-13/16	FAFNIR	FU 0304-2	RCJT 75 S	INA	FU 0511-2	RCJY 1 3/4"	INA	FU 0275-1	RMEY 35	INA	FU 0208-1
RCJ-1-15/16	FAFNIR	FU 0322-2	RCJT-1	FAFNIR	FU 0107-2	RCJY 1 3/4"-MP	INA	FU 0276-1	RMEY 40	INA	FU 0250-1
RCJ-13/16	FAFNIR	FU 0063-2	RCJT-1-1/16	FAFNIR	FU 0119-2	RCJY 1 3/8"	INA	FU 0191-1	RMEY 45	INA	FU 0288-1
RCJ-1-3/16	FAFNIR	FU 0147-2	RCJT-1-1/2	FAFNIR	FU 0233-2	RCJY 1"	INA	FU 0100-1	RMEY 50	INA	FU 0327-1
RCJ-1-3/4	FAFNIR	FU 0283-2	RCJT-1-1/4	FAFNIR	FU 0174-2	RCJY 1/2"	INA	FU 0008-1	RMEY 55	INA	FU 0372-1
RCJ-1-3/8	FAFNIR	FU 0201-2	RCJT-1-1/8	FAFNIR	FU 0130-2	RCJY 12	INA	FU 0003-1	RMEY 60	INA	FU 0407-1
RCJ-15/16	FAFNIR	FU 0085-2	RCJT-1-11/16	FAFNIR	FU 0270-2	RCJY 15	INA	FU 0018-1	RMEY 65-213	INA	FU 0441-1
RCJ-1-5/16	FAFNIR	FU 0190-2	RCJT-1-13/16	FAFNIR	FU 0301-2	RCJY 17	INA	FU 0028-1	RMEY 7/8"	INA	FU 0069-1
RCJ-1-5/8	FAFNIR	FU 0265-2	RCJT-1-15/16	FAFNIR	FU 0319-2	RCJY 2 1/2"-213	INA	FU 0430-1	RMEY 70	INA	FU 0480-1
RCJ-1-7/16	FAFNIR	FU 0226-2	RCJT-13/16	FAFNIR	FU 0060-2	RCJY 2 1/2"-MP	INA	FU 0431-1	RMEY 75	INA	FU 0509-1
RCJ-1-7/8	FAFNIR	FU 0313-2	RCJT-1-3/16	FAFNIR	FU 0155-2	RCJY 2 15/16"	INA	FU 0501-1	RMEY 80	INA	FU 0536-1
RCJ-1-9/16	FAFNIR	FU 0236-2	RCJT-1-3/4	FAFNIR	FU 0279-2	RCJY 2 7/16"	INA	FU 0422-1	RMEY 90	INA	FU 0558-1
RCJ-2	FAFNIR	FU 0351-2	RCJT-1-3/8	FAFNIR	FU 0198-2	RCJY 2"	INA	FU 0336-1	SAF 204	SLB	FU 0044-3
RCJ-20	FAFNIR	FU 0043-2	RCJT-15/16	FAFNIR	FU 0082-2	RCJY 2"-MP	INA	FU 0337-1	SAF 204-12	SLB	FU 0037-3
RCJ-2-1/16	FAFNIR	FU 0359-2	RCJT-1-5/16	FAFNIR	FU 0187-2	RCJY 20	INA	FU 0044-1	SAF 205	SLB	FU 0086-3
RCJ-2-1/4	FAFNIR	FU 0394-2	RCJT-1-5/8	FAFNIR	FU 0261-2	RCJY 25	INA	FU 0086-1	SAF 205-13	SLB	FU 0053-3
RCJ-2-1/8	FAFNIR	FU 0367-2	RCJT-1-7/16	FAFNIR	FU 0223-2	RCJY 3/4"	INA	FU 0037-1	SAF 205-14	SLB	FU 0064-3
RCJ-2-15/16	FAFNIR	FU 0506-2	RCJT-1-7/8	FAFNIR	FU 0310-2	RCJY 30	INA	FU 0134-1	SAF 205-15	SLB	FU 0075-3
RCJ-2-3/16	FAFNIR	FU 0386-2	RCJT-2	FAFNIR	FU 0346-2	RCJY 35	INA	FU 0202-1	SAF 205-16	SLB	FU 0100-3
RCJ-2-3/8	FAFNIR	FU 0421-2	RCJT-20	FAFNIR	FU 0050-2	RCJY 40	INA	FU 0246-1	SAF 206	SLB	FU 0134-3
RCJ-25	FAFNIR	FU 0099-2	RCJT-2-1/16	FAFNIR	FU 0357-2	RCJY 40-MP	INA	FU 0248-1	SAF 206-17	SLB	FU 0112-3
RCJ-2-5/16	FAFNIR	FU 0402-2	RCJT-2-1/8	FAFNIR	FU 0365-2	RCJY 45	INA	FU 0284-1	SAF 206-18	SLB	FU 0123-3

BY PART NUMBER

BY PART NUMBER

Part No.	Brand	Group No.	Part No.	Brand	Group No.	Part No.	Brand	Group No.	Part No.	Brand	Group No.
SAF 206-19	SLB	FU 0148-3	SAFL 209-28	SLB	FU 0279-3	SAFT 210-30	SLB	FU 0309-3	SAPFL 205	FYH	FU 0088-1
SAF 206-20	SLB	FU 0159-3	SAFL 210	SLB	FU 0330-3	SAFT 210-31	SLB	FU 0318-3	SAPFL 205-13	SLB	FU 0055-1
SAF 207	SLB	FU 0202-3	SAFL 210-30	SLB	FU 0310-3	SAFT 210-32	SLB	FU 0343-3	SAPFL 205-14	SLB	FU 0066-1
SAF 207-20	SLB	FU 0162-3	SAFL 210-31	SLB	FU 0319-3	SAFT 211	SLB	FU 0374-3	SAPFL 205-14	FYH	FU 0066-1
SAF 207-21	SLB	FU 0180-3	SAFL 211	SLB	FU 0375-3	SAFT 211-32	SLB	FU 0345-3	SAPFL 205-15	SLB	FU 0077-1
SAF 207-22	SLB	FU 0191-3	SAFL 211-32	SLB	FU 0346-3	SAFT 211-33	SLB	FU 0356-3	SAPFL 205-16	SLB	FU 0102-1
SAF 207-23	SLB	FU 0216-3	SAFL 211-35	SLB	FU 0384-3	SAFT 211-34	SLB	FU 0364-3	SAPFL 205-16	FYH	FU 0102-1
SAF 208	SLB	FU 0246-3	SAFL 204	SLB	FU 0043-3	SAFT 211-35	SLB	FU 0383-3	SAPFL 206	SLB	FU 0136-1
SAF 208-24	SLB	FU 0228-3	SAFL 204-12	SLB	FU 0036-3	SAPF 201	SLB	FU 0001-1	SAPFL 206	FYH	FU 0136-1
SAF 208-25	SLB	FU 0237-3	SAFL 205	SLB	FU 0099-3	SAPF 201	FYH	FU 0001-1	SAPFL 206-17	SLB	FU 0114-1
SAF 209	SLB	FU 0284-3	SAFL 205-13	SLB	FU 0063-3	SAPF 201-8	SLB	FU 0006-1	SAPFL 206-18	SLB	FU 0125-1
SAF 209-26	SLB	FU 0257-3	SAFL 205-14	SLB	FU 0074-3	SAPF 201-8	FYH	FU 0006-1	SAPFL 206-18	FYH	FU 0125-1
SAF 209-27	SLB	FU 0266-3	SAFL 205-15	SLB	FU 0085-3	SAPF 202	SLB	FU 0016-1	SAPFL 206-19	SLB	FU 0150-1
SAF 209-28	SLB	FU 0275-3	SAFL 205-16	SLB	FU 0110-3	SAPF 202	FYH	FU 0016-1	SAPFL 206-19	FYH	FU 0150-1
SAF 210	SLB	FU 0323-3	SAFL 206	SLB	FU 0133-3	SAPF 202-10	SLB	FU 0021-1	SAPFL 206-20	SLB	FU 0161-1
SAF 210-30	SLB	FU 0305-3	SAFL 206-17	SLB	FU 0111-3	SAPF 202-10	FYH	FU 0021-1	SAPFL 206-20	FYH	FU 0161-1
SAF 210-31	SLB	FU 0314-3	SAFL 206-18	SLB	FU 0122-3	SAPF 202-9	SLB	FU 0011-1	SAPFL 207	SLB	FU 0204-1
SAF 211	SLB	FU 0368-3	SAFL 206-19	SLB	FU 0147-3	SAPF 203	SLB	FU 0026-1	SAPFL 207-20	SLB	FU 0166-1
SAF 211-32	SLB	FU 0336-3	SAFL 206-20	SLB	FU 0158-3	SAPF 203	FYH	FU 0026-1	SAPFL 207-21	SLB	FU 0182-1
SAF 211-35	SLB	FU 0379-3	SAFL 207	SLB	FU 0215-3	SAPF 203-11	SLB	FU 0031-1	SAPFL 207-22	SLB	FU 0193-1
SAFC 204	SLB	FU 0048-3	SAFL 207-20	SLB	FU 0179-3	SAPF 204	SLB	FU 0046-1	SAPFL 207-23	SLB	FU 0218-1
SAFC 204-12	SLB	FU 0040-3	SAFL 207-21	SLB	FU 0190-3	SAPF 204	FYH	FU 0046-1	SBF 204	SLB	FU 0044-4
SAFC 205	SLB	FU 0092-3	SAFL 207-22	SLB	FU 0201-3	SAPF 204-12	SLB	FU 0038-1	SBF 204-12	SLB	FU 0037-4
SAFC 205-14	SLB	FU 0069-3	SAFL 207-23	SLB	FU 0226-3	SAPF 204-12	FYH	FU 0038-1	SBF 205	SLB	FU 0086-4
SAFC 205-15	SLB	FU 0080-3	SAFL 208	SLB	FU 0245-3	SAPF 205	SLB	FU 0087-1	SBF 205-14	SLB	FU 0064-4
SAFC 205-16	SLB	FU 0105-3	SAFL 208-24	SLB	FU 0227-3	SAPF 205	FYH	FU 0087-1	SBF 205-15	SLB	FU 0075-4
SAFC 206	SLB	FU 0140-3	SAFL 208-25	SLB	FU 0236-3	SAPF 205-13	SLB	FU 0054-1	SBF 205-16	SLB	FU 0100-4
SAFC 206-18	SLB	FU 0128-3	SAFL 209	SLB	FU 0295-3	SAPF 205-14	SLB	FU 0065-1	SBF 206	SLB	FU 0134-4
SAFC 206-19	SLB	FU 0153-3	SAFL 209-26	SLB	FU 0265-3	SAPF 205-14	FYH	FU 0065-1	SBF 206-18	SLB	FU 0123-4
SAFC 206-20	SLB	FU 0167-3	SAFL 209-27	SLB	FU 0274-3	SAPF 205-15	SLB	FU 0076-1	SBF 206-19	SLB	FU 0148-4
SAFC 207	SLB	FU 0208-3	SAFL 209-28	SLB	FU 0283-3	SAPF 205-16	SLB	FU 0101-1	SBF 206-20	SLB	FU 0159-4
SAFC 207-20	SLB	FU 0170-3	SAFL 210	SLB	FU 0334-3	SAPF 205-16	FYH	FU 0101-1	SBF 207	SLB	FU 0202-4
SAFC 207-22	SLB	FU 0196-3	SAFL 210-29	SLB	FU 0304-3	SAPF 206	SLB	FU 0135-1	SBF 207-20	SLB	FU 0162-4
SAFC 207-23	SLB	FU 0221-3	SAFL 210-30	SLB	FU 0313-3	SAPF 206	FYH	FU 0135-1	SBF 207-21	SLB	FU 0180-4
SAFC 208	SLB	FU 0250-3	SAFL 210-31	SLB	FU 0322-3	SAPF 206-17	SLB	FU 0113-1	SBF 207-22	SLB	FU 0191-4
SAFC 208-24	SLB	FU 0231-3	SAFL 210-32	SLB	FU 0350-3	SAPF 206-18	SLB	FU 0124-1	SBF 207-23	SLB	FU 0216-4
SAFC 209	SLB	FU 0288-3	SAFL 211	SLB	FU 0378-3	SAPF 206-18	FYH	FU 0124-1	SBF 208	SLB	FU 0246-4
SAFC 209-26	SLB	FU 0260-3	SAFL 211-32	SLB	FU 0351-3	SAPF 206-19	SLB	FU 0149-1	SBFC 204	SLB	FU 0048-4
SAFC 209-27	SLB	FU 0269-3	SAFL 211-33	SLB	FU 0359-3	SAPF 206-19	FYH	FU 0149-1	SBFC 204-12	SLB	FU 0040-4
SAFC 209-28	SLB	FU 0278-3	SAFL 211-34	SLB	FU 0367-3	SAPF 206-20	SLB	FU 0160-1	SBFC 205	SLB	FU 0092-4
SAFC 210	SLB	FU 0327-3	SAFL 211-35	SLB	FU 0386-3	SAPF 206-20	FYH	FU 0160-1	SBFC 205-14	SLB	FU 0069-4
SAFC 210-30	SLB	FU 0308-3	SAFT 204	SLB	FU 0049-3	SAPF 207	SLB	FU 0203-1	SBFC 205-15	SLB	FU 0080-4
SAFC 210-31	SLB	FU 0317-3	SAFT 204-12	SLB	FU 0041-3	SAPF 207	FYH	FU 0203-1	SBFC 205-16	SLB	FU 0105-4
SAFC 211	SLB	FU 0372-3	SAFT 205	SLB	FU 0093-3	SAPF 207-20	SLB	FU 0165-1	SBFC 206	SLB	FU 0140-4
SAFL 204	SLB	FU 0050-3	SAFT 205-13	SLB	FU 0059-3	SAPF 207-20	FYH	FU 0165-1	SBFC 206-18	SLB	FU 0128-4
SAFL 204-12	SLB	FU 0042-3	SAFT 205-14	SLB	FU 0070-3	SAPF 207-21	SLB	FU 0181-1	SBFC 206-19	SLB	FU 0153-4
SAFL 205	SLB	FU 0094-3	SAFT 205-15	SLB	FU 0081-3	SAPF 207-22	SLB	FU 0192-1	SBFC 206-20	SLB	FU 0167-4
SAFL 205-13	SLB	FU 0060-3	SAFT 205-16	SLB	FU 0106-3	SAPF 207-22	FYH	FU 0192-1	SBFC 207	SLB	FU 0208-4
SAFL 205-14	SLB	FU 0071-3	SAFT 206	SLB	FU 0142-3	SAPF 207-23	SLB	FU 0217-1	SBFC 207-20	SLB	FU 0170-4
SAFL 205-15	SLB	FU 0082-3	SAFT 206-17	SLB	FU 0118-3	SAPF 207-23	FYH	FU 0217-1	SBFC 207-21	SLB	FU 0185-4
SAFL 205-16	SLB	FU 0107-3	SAFT 206-18	SLB	FU 0129-3	SAPFL 201	SLB	FU 0002-1	SBFC 207-22	SLB	FU 0196-4
SAFL 206	SLB	FU 0143-3	SAFT 206-19	SLB	FU 0154-3	SAPFL 201	FYH	FU 0002-1	SBFC 207-23	SLB	FU 0221-4
SAFL 206-17	SLB	FU 0119-3	SAFT 206-20	SLB	FU 0171-3	SAPFL 201-8	SLB	FU 0007-1	SBFC 208	SLB	FU 0250-4
SAFL 206-18	SLB	FU 0130-3	SAFT 207	SLB	FU 0210-3	SAPFL 201-8	FYH	FU 0007-1	SBFC 208-24	SLB	FU 0231-4
SAFL 206-19	SLB	FU 0155-3	SAFT 207-20	SLB	FU 0173-3	SAPFL 202	SLB	FU 0017-1	SBFL 204	SLB	FU 0050-4
SAFL 206-20	SLB	FU 0172-3	SAFT 207-21	SLB	FU 0186-3	SAPFL 202	FYH	FU 0017-1	SBFL 204-12	SLB	FU 0042-4
SAFL 207	SLB	FU 0211-3	SAFT 207-22	SLB	FU 0197-3	SAPFL 202-10	SLB	FU 0022-1	SBFL 205	SLB	FU 0094-4
SAFL 207-20	SLB	FU 0174-3	SAFT 207-23	SLB	FU 0222-3	SAPFL 202-10	FYH	FU 0022-1	SBFL 205-14	SLB	FU 0071-4
SAFL 207-21	SLB	FU 0187-3	SAFT 208	SLB	FU 0252-3	SAPFL 202-9	SLB	FU 0012-1	SBFL 205-15	SLB	FU 0082-4
SAFL 207-22	SLB	FU 0198-3	SAFT 208-24	SLB	FU 0232-3	SAPFL 203	SLB	FU 0027-1	SBFL 205-16	SLB	FU 0107-4
SAFL 207-23	SLB	FU 0223-3	SAFT 208-25	SLB	FU 0241-3	SAPFL 203	FYH	FU 0027-1	SBFL 206	SLB	FU 0143-4
SAFL 208	SLB	FU 0253-3	SAFT 209	SLB	FU 0291-3	SAPFL 203-11	SLB	FU 0032-1	SBFL 206-18	SLB	FU 0130-4
SAFL 208-24	SLB	FU 0233-3	SAFT 209-26	SLB	FU 0262-3	SAPFL 204	SLB	FU 0047-1	SBFL 206-19	SLB	FU 0155-4
SAFL 208-25	SLB	FU 0242-3	SAFT 209-27	SLB	FU 0271-3	SAPFL 204	FYH	FU 0047-1	SBFL 206-20	SLB	FU 0172-4
SAFL 209	SLB	FU 0290-3	SAFT 209-28	SLB	FU 0280-3	SAPFL 204-12	SLB	FU 0039-1	SBFL 207	SLB	FU 0211-4
SAFL 209-26	SLB	FU 0261-3	SAFT 210	SLB	FU 0329-3	SAPFL 204-12	FYH	FU 0039-1	SBFL 207-20	SLB	FU 0174-4
SAFL 209-27	SLB	FU 0270-3	SAFT 210-29	SLB	FU 0300-3	SAPFL 205	SLB	FU 0088-1	SBFL 207-21	SLB	FU 0187-4

BY PART NUMBER

Part No.	Brand	Group No.	Part No.	Brand	Group No.	Part No.	Brand	Group No.	Part No.	Brand	Group No.
SBFL 207-22	SLB	FU 0198-4	SBPF 207	SLB	FU 0203-2	SF1 1/4	RHP	FU 0179-1	SF2 3/8DEC	RHP	FU 0421-2
SBFL 207-23	SLB	FU 0223-4	SBPF 207	FYH	FU 0203-2	SF1 1/4A	RHP	FU 0179-4	SF2 7/16	RHP	FU 0429-1
SBFL 208	SLB	FU 0253-4	SBPF 207-20	SLB	FU 0165-2	SF1 1/4AR	RHP	FU 0158-4	SF2 7/16DEC	RHP	FU 0429-2
SBFS 204	SLB	FU 0043-4	SBPF 207-20	FYH	FU 0165-2	SF1 1/4DEC	RHP	FU 0179-2	SF2 7/8	RHP	FU 0499-1
SBFS 204-12	SLB	FU 0036-4	SBPF 207-21	SLB	FU 0181-2	SF1 1/4DEC	RHP	FU 0158-2	SF2 7/8DEC	RHP	FU 0499-2
SBFS 205	SLB	FU 0099-4	SBPF 207-22	SLB	FU 0192-2	SF1 1/4EC	RHP	FU 0179-3	SF20	RHP	FU 0043-1
SBFS 205-14	SLB	FU 0074-4	SBPF 207-22	FYH	FU 0192-2	SF1 1/4ECR	RHP	FU 0158-3	SF20	SNR	FU 0043-1
SBFS 205-15	SLB	FU 0085-4	SBPF 207-23	SLB	FU 0217-2	SBPF 207-23	RHP	FU 0158-1	SF-20	SEALMASTER	FU 0162-1
SBFS 205-16	SLB	FU 0110-4	SBPF 207-23	FYH	FU 0217-2	SF1 1/8	RHP	FU 0122-1	SF-204	SEALMASTER	FU 0044-1
SBFS 206	SLB	FU 0133-4	SBPFL 201	SLB	FU 0002-2	SF1 1/8DEC	RHP	FU 0122-2	SF-205	SEALMASTER	FU 0086-1
SBFS 206-18	SLB	FU 0122-4	SBPFL 201	FYH	FU 0002-2	SF1 1/8EC	RHP	FU 0122-3	SF-206	SEALMASTER	FU 0134-1
SBFS 206-19	SLB	FU 0147-4	SBPFL 201-8	SLB	FU 0007-2	SF1 11/16	RHP	FU 0274-1	SF-207	SEALMASTER	FU 0202-1
SBFS 206-20	SLB	FU 0158-4	SBPFL 201-8	FYH	FU 0007-2	SF1 11/16DEC	RHP	FU 0274-2	SF-208	SEALMASTER	FU 0246-1
SBFS 207	SLB	FU 0215-4	SBPFL 202	SLB	FU 0017-2	SF1 11/16EC	RHP	FU 0274-3	SF-209	SEALMASTER	FU 0284-1
SBFS 207-20	SLB	FU 0179-4	SBPFL 202	FYH	FU 0017-2	SF1 15/16	RHP	FU 0322-1	SF20A	RHP	FU 0043-4
SBFS 207-22	SLB	FU 0201-4	SBPFL 202-10	SLB	FU 0022-2	SF1 15/16DEC	RHP	FU 0322-2	SF20A	SNR	FU 0043-4
SBFS 207-23	SLB	FU 0226-4	SBPFL 202-10	FYH	FU 0022-2	SF1 15/16EC	RHP	FU 0322-3	SF20DEC	RHP	FU 0043-2
SBFS 208	SLB	FU 0245-4	SBPFL 202-9	SLB	FU 0012-2	SF1 3/16	RHP	FU 0147-1	SF20EC	RHP	FU 0043-3
SBFS 208-24	SLB	FU 0227-4	SBPFL 203	SLB	FU 0027-2	SF1 3/16DEC	RHP	FU 0147-2	SF20EC	SNR	FU 0043-3
SBFT 204	SLB	FU 0049-4	SBPFL 203	FYH	FU 0027-2	SF1 3/16EC	RHP	FU 0147-3	SF-20R	SEALMASTER	FU 0159-1
SBFT 204-12	SLB	FU 0041-4	SBPFL 203-11	SLB	FU 0032-2	SF1 3/4	RHP	FU 0283-1	SF-21	SEALMASTER	FU 0180-1
SBFT 205	SLB	FU 0093-4	SBPFL 204	SLB	FU 0047-2	SF1 3/4DEC	RHP	FU 0283-2	SF-210	SEALMASTER	FU 0323-1
SBFT 205-14	SLB	FU 0070-4	SBPFL 204	FYH	FU 0047-2	SF1 3/4EC	RHP	FU 0283-3	SF-211	SEALMASTER	FU 0368-1
SBFT 205-15	SLB	FU 0081-4	SBPFL 204-12	SLB	FU 0039-2	SF1 3/8	RHP	FU 0201-1	SF-212	SEALMASTER	FU 0403-1
SBFT 205-16	SLB	FU 0106-4	SBPFL 204-12	FYH	FU 0039-2	SF1 3/8DEC	RHP	FU 0201-2	SF-214	SEALMASTER	FU 0478-1
SBFT 206	SLB	FU 0142-4	SBPFL 205	SLB	FU 0088-2	SF1 3/8EC	RHP	FU 0201-3	SF-215	SEALMASTER	FU 0508-1
SBFT 206-18	SLB	FU 0129-4	SBPFL 205	FYH	FU 0088-2	SF1 5/8	RHP	FU 0265-1	SF-22	SEALMASTER	FU 0191-1
SBFT 206-19	SLB	FU 0154-4	SBPFL 205-13	SLB	FU 0055-2	SF1 5/8DEC	RHP	FU 0265-2	SF-23	SEALMASTER	FU 0216-1
SBFT 206-20	SLB	FU 0171-4	SBPFL 205-14	SLB	FU 0066-2	SF1 5/8EC	RHP	FU 0265-3	SF-24	SEALMASTER	FU 0228-1
SBFT 207	SLB	FU 0210-4	SBPFL 205-14	FYH	FU 0066-2	SF1 7/16	RHP	FU 0226-1	SF25	RHP	FU 0099-1
SBFT 207-20	SLB	FU 0173-4	SBPFL 205-15	SLB	FU 0077-2	SF1 7/16DEC	RHP	FU 0226-2	SF25	SNR	FU 0099-1
SBFT 207-22	SLB	FU 0197-4	SBPFL 205-16	SLB	FU 0102-2	SF1 7/16EC	RHP	FU 0226-3	SF-25	SEALMASTER	FU 0237-1
SBFT 207-23	SLB	FU 0222-4	SBPFL 205-16	FYH	FU 0102-2	SF1 7/8	RHP	FU 0313-1	SF25A	RHP	FU 0099-4
SBFT 208	SLB	FU 0252-4	SBPFL 206	SLB	FU 0136-2	SF1 7/8DEC	RHP	FU 0313-2	SF25A	SNR	FU 0099-4
SBFT 208-24	SLB	FU 0232-4	SBPFL 206	FYH	FU 0136-2	SF1 7/8EC	RHP	FU 0313-3	SF25DEC	RHP	FU 0099-2
SBPF 201	SLB	FU 0001-2	SBPFL 206-17	SLB	FU 0114-2	SF-10	SEALMASTER	FU 0023-1	SF25EC	RHP	FU 0099-3
SBPF 201	FYH	FU 0001-2	SBPFL 206-18	SLB	FU 0125-2	SF-11	SEALMASTER	FU 0033-1	SF25EC	SNR	FU 0099-3
SBPF 201-8	SLB	FU 0006-2	SBPFL 206-18	FYH	FU 0125-2	SF-12	SEALMASTER	FU 0037-1	SF-26	SEALMASTER	FU 0257-1
SBPF 201-8	FYH	FU 0006-2	SBPFL 206-19	SLB	FU 0150-2	SF-13	SEALMASTER	FU 0053-1	SF-27	SEALMASTER	FU 0266-1
SBPF 202	SLB	FU 0016-2	SBPFL 206-19	FYH	FU 0150-2	SF-14	SEALMASTER	FU 0064-1	SF-28	SEALMASTER	FU 0275-1
SBPF 202	FYH	FU 0016-2	SBPFL 206-20	SLB	FU 0161-2	SF-15	SEALMASTER	FU 0075-1	SF-29	SEALMASTER	FU 0296-1
SBPF 202-10	SLB	FU 0021-2	SBPFL 207	SLB	FU 0204-2	SF15/16	RHP	FU 0085-1	SF2DEC	RHP	FU 0351-2
SBPF 202-10	FYH	FU 0021-2	SBPFL 207-20	SLB	FU 0166-2	SF15/16DEC	RHP	FU 0085-2	SF2R	RHP	FU 0350-1
SBPF 202-9	SLB	FU 0011-2	SBPFL 207-21	SLB	FU 0182-2	SF15/16EC	RHP	FU 0085-3	SF3	RHP	FU 0520-1
SBPF 203	SLB	FU 0026-2	SBPFL 207-22	SLB	FU 0193-2	SF-16	SEALMASTER	FU 0100-1	SF3/4	RHP	FU 0036-1
SBPF 203	FYH	FU 0026-2	SBPFL 207-23	SLB	FU 0218-2	SF-17	SEALMASTER	FU 0112-1	SF3/4A	RHP	FU 0036-4
SBPF 203-11	SLB	FU 0031-2	SCJT-1	FAFNIR	FU 0106-4	SF-18	SEALMASTER	FU 0123-1	SF3/4DEC	RHP	FU 0036-2
SBPF 204	SLB	FU 0046-2	SCJT-1-1/2	FAFNIR	FU 0232-4	SF-19	SEALMASTER	FU 0148-1	SF3/4EC	RHP	FU 0036-3
SBPF 204	FYH	FU 0046-2	SCJT-1-1/4	FAFNIR	FU 0173-4	SF1A	RHP	FU 0110-4	SF30	RHP	FU 0133-1
SBPF 204-12	SLB	FU 0038-2	SCJT-1-1/4S	FAFNIR	FU 0171-4	SF1EC	RHP	FU 0110-3	SF30	SNR	FU 0133-1
SBPF 204-12	FYH	FU 0038-2	SCJT-1-1/8	FAFNIR	FU 0129-4	SF1EDEC	RHP	FU 0110-2	SF-30	SEALMASTER	FU 0305-1
SBPF 205	SLB	FU 0087-2	SCJT-1-3/16	FAFNIR	FU 0154-4	SF2	RHP	FU 0351-1	SF30A	RHP	FU 0133-4
SBPF 205	FYH	FU 0087-2	SCJT-1-3/8	FAFNIR	FU 0197-4	SF2 1/2	RHP	FU 0437-1	SF30A	SNR	FU 0133-4
SBPF 205-13	SLB	FU 0054-2	SCJT-15/16	FAFNIR	FU 0081-4	SF2 1/2DEC	RHP	FU 0437-2	SF30DEC	RHP	FU 0133-2
SBPF 205-14	SLB	FU 0065-2	SCJT-1-7/16	FAFNIR	FU 0222-4	SF2 1/4	RHP	FU 0394-1	SF30EC	RHP	FU 0133-3
SBPF 205-14	FYH	FU 0065-2	SCJT-20	FAFNIR	FU 0049-4	SF2 1/4DEC	RHP	FU 0394-2	SF30EC	SNR	FU 0133-3
SBPF 205-15	SLB	FU 0076-2	SCJT-25	FAFNIR	FU 0093-4	SF2 1/8	RHP	FU 0367-1	SF-31	SEALMASTER	FU 0314-1
SBPF 205-16	SLB	FU 0101-2	SCJT-3/4	FAFNIR	FU 0041-4	SF2 1/8DEC	RHP	FU 0367-2	SF-32	SEALMASTER	FU 0336-1
SBPF 205-16	FYH	FU 0101-2	SCJT-30	FAFNIR	FU 0142-4	SF2 11/16	RHP	FU 0469-1	SF-32R	SEALMASTER	FU 0335-1
SBPF 206	SLB	FU 0135-2	SCJT-35	FAFNIR	FU 0210-4	SF2 11/16DEC	RHP	FU 0469-2	SF-34	SEALMASTER	FU 0360-1
SBPF 206	FYH	FU 0135-2	SCJT-40	FAFNIR	FU 0252-4	SF2 15/16	RHP	FU 0506-1	SF35	RHP	FU 0215-1
SBPF 206-17	SLB	FU 0113-2	SCJT-7/8	FAFNIR	FU 0070-4	SF2 15/16DEC	RHP	FU 0506-2	SF35	SNR	FU 0215-1
SBPF 206-18	SLB	FU 0124-2	SF1	RHP	FU 0110-1	SF2 3/16	RHP	FU 0386-1	SF-35	SEALMASTER	FU 0379-1
SBPF 206-18	FYH	FU 0124-2	SF1 1/2	RHP	FU 0227-1	SF2 3/16DEC	RHP	FU 0386-2	SF35A	RHP	FU 0215-4
SBPF 206-19	SLB	FU 0149-2	SF1 1/2A	RHP	FU 0227-4	SF2 3/4	RHP	FU 0477-1	SF35A	SNR	FU 0215-4
SBPF 206-19	FYH	FU 0149-2	SF1 1/2DEC	RHP	FU 0227-2	SF2 3/4DEC	RHP	FU 0477-2	SF35DEC	RHP	FU 0215-2
SBPF 206-20	SLB	FU 0160-2	SF1 1/2EC	RHP	FU 0227-3	SF2 3/8	RHP	FU 0421-1	SF35EC	RHP	FU 0215-3

BY PART NUMBER

BY PART NUMBER

Part No.	Brand	Group No.	Part No.	Brand	Group No.	Part No.	Brand	Group No.	Part No.	Brand	Group No.
SF35EC	SNR	FU 0215-3	SFT1 3/4	RHP	FU 0280-1	SFT25A	SNR	FU 0093-4	SLF 206-18	FYH	FU 0122-1
SF-36	SEALMASTER	FU 0387-1	SFT1 3/4DEC	RHP	FU 0280-2	SFT25DEC	RHP	FU 0093-2	SLF 206-19	FYH	FU 0147-1
SF-38	SEALMASTER	FU 0414-1	SFT1 3/4EC	RHP	FU 0280-3	SFT25EC	RHP	FU 0093-3	SLF 207	FYH	FU 0215-1
SF-39	SEALMASTER	FU 0422-1	SFT1 3/8	RHP	FU 0197-1	SFT25EC	SNR	FU 0093-3	SLF 207-20	FYH	FU 0179-1
SF40	RHP	FU 0245-1	SFT1 3/8DEC	RHP	FU 0197-2	SFT-26	SEALMASTER	FU 0261-1	SLF 207-21	FYH	FU 0190-1
SF40	SNR	FU 0245-1	SFT1 3/8EC	RHP	FU 0197-3	SFT-27	SEALMASTER	FU 0270-1	SLF 207-22	FYH	FU 0201-1
SF-40	SEALMASTER	FU 0430-1	SFT1 5/8	RHP	FU 0262-1	SFT-28	SEALMASTER	FU 0279-1	SLF 207-23	FYH	FU 0226-1
SF40A	RHP	FU 0245-4	SFT1 5/8DEC	RHP	FU 0262-2	SFT-29	SEALMASTER	FU 0301-1	SLF 208	FYH	FU 0245-1
SF40A	SNR	FU 0245-4	SFT1 5/8EC	RHP	FU 0262-3	SFT2DEC	RHP	FU 0345-2	SLF 208-24	FYH	FU 0227-1
SF40DEC	RHP	FU 0245-2	SFT1 7/16	RHP	FU 0222-1	SFT2R	RHP	FU 0343-1	SLF 208-25	FYH	FU 0236-1
SF40EC	RHP	FU 0245-3	SFT1 7/16DEC	RHP	FU 0222-2	SFT3/4	RHP	FU 0041-1	SLF 209	FYH	FU 0295-1
SF40EC	SNR	FU 0245-3	SFT1 7/16EC	RHP	FU 0222-3	SFT3/4A	RHP	FU 0041-4	SLF 209-26	FYH	FU 0265-1
SF-43	SEALMASTER	FU 0462-1	SFT1 7/8	RHP	FU 0309-1	SFT3/4DEC	RHP	FU 0041-2	SLF 209-27	FYH	FU 0274-1
SF45	RHP	FU 0295-1	SFT1 7/8DEC	RHP	FU 0309-2	SFT3/4EC	RHP	FU 0041-3	SLF 209-28	FYH	FU 0283-1
SF45	SNR	FU 0295-1	SFT1 7/8EC	RHP	FU 0309-3	SFT30	RHP	FU 0142-1	SLF 210	FYH	FU 0334-1
SF45DEC	RHP	FU 0295-2	SFT-10	SEALMASTER	FU 0025-1	SFT30	SNR	FU 0142-1	SLF 210-30	FYH	FU 0313-1
SF45EC	RHP	FU 0295-3	SFT-11	SEALMASTER	FU 0035-1	SFT-30	SEALMASTER	FU 0310-1	SLF 210-31	FYH	FU 0322-1
SF45EC	SNR	FU 0295-3	SFT-12	SEALMASTER	FU 0042-1	SFT-31	RHP	FU 0142-4	SLF 211	FYH	FU 0378-1
SF-46	SEALMASTER	FU 0494-1	SFT-13	SEALMASTER	FU 0060-1	SFT30A	RHP	FU 0142-4	SLF 211-32	FYH	FU 0351-1
SF-47	SEALMASTER	FU 0501-1	SFT-14	SEALMASTER	FU 0071-1	SFT30A	SNR	FU 0142-4	SLF 211-34	FYH	FU 0367-1
SF50	RHP	FU 0334-1	SFT-15	SEALMASTER	FU 0082-1	SFT30DEC	RHP	FU 0142-2	SLF 211-35	FYH	FU 0386-1
SF50	SNR	FU 0334-1	SFT15/16	RHP	FU 0081-1	SFT30EC	RHP	FU 0142-3	SLF 212	FYH	FU 0413-1
SF50DEC	RHP	FU 0334-2	SFT15/16DEC	RHP	FU 0081-2	SFT30EC	SNR	FU 0142-3	SLF 212-36	FYH	FU 0394-1
SF50EC	RHP	FU 0334-3	SFT15/16EC	RHP	FU 0081-3	SFT-31	SEALMASTER	FU 0319-1	SLF 212-38	FYH	FU 0421-1
SF50EC	SNR	FU 0334-3	SFT-16	SEALMASTER	FU 0107-1	SFT-32R	SEALMASTER	FU 0344-1	SLF 212-39	FYH	FU 0429-1
SF55	RHP	FU 0378-1	SFT-17	SEALMASTER	FU 0119-1	SFT-32R	SEALMASTER	FU 0346-1	SLF 214	FYH	FU 0485-1
SF55	SNR	FU 0378-1	SFT-18	SEALMASTER	FU 0130-1	SFT-34	SEALMASTER	FU 0365-1	SLF 214-44	FYH	FU 0477-1
SF55DEC	RHP	FU 0378-2	SFT-19	SEALMASTER	FU 0155-1	SFT35	RHP	FU 0210-1	SLF 215	FYH	FU 0513-1
SF60	RHP	FU 0413-1	SFT1A	RHP	FU 0106-4	SFT35	SNR	FU 0210-1	SLF 215-48	FYH	FU 0520-1
SF60	SNR	FU 0413-1	SFT1EC	RHP	FU 0106-3	SFT-35	SEALMASTER	FU 0384-1	SLFE1 1/4A	RHP	FU 0160-2
SF60DEC	RHP	FU 0413-2	SFT1EDEC	RHP	FU 0106-2	SFT35A	RHP	FU 0210-4	SLFE1 1/4AL	RHP	FU 0165-2
SF65	RHP	FU 0445-1	SFT2	RHP	FU 0345-1	SFT35A	SNR	FU 0210-4	SLFE1 1/4EC	RHP	FU 0160-1
SF65DEC	RHP	FU 0445-2	SFT2 1/4	RHP	FU 0391-1	SFT35DEC	RHP	FU 0210-2	SLFE1 1/4ECL	RHP	FU 0165-1
SF7/8	RHP	FU 0074-1	SFT2 1/4DEC	RHP	FU 0391-2	SFT35EC	SNR	FU 0210-3	SLFE1 1/8EC	RHP	FU 0124-1
SF7/8DEC	RHP	FU 0074-2	SFT2 1/8	RHP	FU 0364-1	SFT40	RHP	FU 0252-1	SLFE1 3/16EC	RHP	FU 0149-1
SF7/8EC	RHP	FU 0074-3	SFT2 1/8DEC	RHP	FU 0364-2	SFT40	SNR	FU 0252-1	SLFE1 3/8EC	RHP	FU 0192-1
SF70	RHP	FU 0485-1	SFT2 3/16	RHP	FU 0383-1	SFT40A	RHP	FU 0252-4	SLFE1 7/16EC	RHP	FU 0217-1
SF70DEC	RHP	FU 0485-2	SFT2 3/16DEC	RHP	FU 0383-2	SFT40A	SNR	FU 0252-4	SLFE1/2EC	RHP	FU 0006-1
SF75	RHP	FU 0513-1	SFT2 3/8	RHP	FU 0418-1	SFT40DEC	RHP	FU 0252-2	SLFE12EC	RHP	FU 0001-1
SF75DEC	RHP	FU 0513-2	SFT2 3/8DEC	RHP	FU 0418-2	SFT40EC	RHP	FU 0252-3	SLFE15/16EC	RHP	FU 0076-1
SF-8	SEALMASTER	FU 0008-1	SFT2 7/16	RHP	FU 0426-1	SFT40EC	SNR	FU 0252-3	SLFE15EC	RHP	FU 0016-1
SF-9	SEALMASTER	FU 0013-1	SFT2 7/16DEC	RHP	FU 0426-2	SFT45	RHP	FU 0291-1	SLFE17EC	RHP	FU 0026-1
SFT1	RHP	FU 0106-1	SFT20	RHP	FU 0049-1	SFT45	SNR	FU 0291-1	SLFE1A	RHP	FU 0101-2
SFT1 1/2	RHP	FU 0232-1	SFT20	SNR	FU 0049-1	SFT45DEC	RHP	FU 0291-2	SLFE1EC	RHP	FU 0101-1
SFT1 1/2A	RHP	FU 0232-4	SFT-20	SEALMASTER	FU 0174-1	SFT45EC	RHP	FU 0291-3	SLFE20A	RHP	FU 0046-2
SFT1 1/2DEC	RHP	FU 0232-2	SFT-20	SEALMASTER	FU 0330-1	SFT45EC	SNR	FU 0291-3	SLFE20EC	RHP	FU 0046-1
SFT1 1/2EC	RHP	FU 0232-3	SFT-204	SEALMASTER	FU 0050-1	SFT50	RHP	FU 0329-1	SLFE25A	RHP	FU 0087-2
SFT1 1/4	RHP	FU 0173-1	SFT-205	SEALMASTER	FU 0094-1	SFT50	SNR	FU 0329-1	SLFE25EC	RHP	FU 0087-1
SFT1 1/4A	RHP	FU 0173-4	SFT-206	SEALMASTER	FU 0143-1	SFT50DEC	RHP	FU 0329-2	SLFE3/4A	RHP	FU 0038-2
SFT1 1/4AR	RHP	FU 0171-4	SFT-207	SEALMASTER	FU 0211-1	SFT50EC	RHP	FU 0329-3	SLFE3/4EC	RHP	FU 0038-1
SFT1 1/4DEC	RHP	FU 0173-2	SFT-208	SEALMASTER	FU 0253-1	SFT50EC	SNR	FU 0329-3	SLFE30A	RHP	FU 0135-2
SFT1 1/4DECR	RHP	FU 0171-2	SFT-209	SEALMASTER	FU 0290-1	SFT55	RHP	FU 0374-1	SLFE30EC	RHP	FU 0135-1
SFT1 1/4EC	RHP	FU 0173-3	SFT20A	RHP	FU 0049-4	SFT55DEC	RHP	FU 0374-2	SLFE35A	RHP	FU 0203-2
SFT1 1/4ECR	RHP	FU 0171-3	SFT20A	SNR	FU 0049-4	SFT60	RHP	FU 0409-1	SLFE35EC	RHP	FU 0203-1
SFT1 1/4R	RHP	FU 0171-1	SFT20DEC	RHP	FU 0049-2	SFT60DEC	RHP	FU 0409-2	SLFE5/8EC	RHP	FU 0021-1
SFT1 1/8	RHP	FU 0129-1	SFT20EC	RHP	FU 0049-3	SFT7/8	RHP	FU 0070-1	SLFE7/8EC	RHP	FU 0065-1
SFT1 1/8DEC	RHP	FU 0129-2	SFT20EC	SNR	FU 0049-3	SFT7/8DEC	RHP	FU 0070-2	SLFL1 1/4A	RHP	FU 0161-2
SFT1 1/8EC	RHP	FU 0129-3	SFT-20R	SEALMASTER	FU 0172-1	SFT7/8EC	RHP	FU 0070-3	SLFL1 1/4EC	RHP	FU 0161-1
SFT1 11/16	RHP	FU 0271-1	SFT-21	SEALMASTER	FU 0187-1	SFT-8	SEALMASTER	FU 0010-1	SLFL1 1/8EC	RHP	FU 0125-1
SFT1 11/16DEC	RHP	FU 0271-2	SFT-211	SEALMASTER	FU 0375-1	SFT-9	SEALMASTER	FU 0015-1	SLFL1 3/16EC	RHP	FU 0150-1
SFT1 11/16EC	RHP	FU 0271-3	SFT-22	SEALMASTER	FU 0198-1	SLF 204	FYH	FU 0043-1	SLFL12EC	RHP	FU 0007-1
SFT1 15/16	RHP	FU 0318-1	SFT-23	SEALMASTER	FU 0223-1	SLF 204-12	FYH	FU 0036-1	SLFL12EC	RHP	FU 0002-1
SFT1 15/16DEC	RHP	FU 0318-2	SFT-24	SEALMASTER	FU 0233-1	SLF 205	FYH	FU 0099-1	SLFL15/16EC	RHP	FU 0077-1
SFT1 15/16EC	RHP	FU 0318-3	SFT25	RHP	FU 0093-1	SLF 205-14	FYH	FU 0074-1	SLFL15EC	RHP	FU 0017-1
SFT1 3/16	RHP	FU 0154-1	SFT25	SNR	FU 0093-1	SLF 205-15	FYH	FU 0085-1	SLFL17EC	RHP	FU 0027-1
SFT1 3/16DEC	RHP	FU 0154-2	SFT-25	SEALMASTER	FU 0242-1	SLF 205-16	FYH	FU 0110-1	SLFL1A	RHP	FU 0102-2
SFT1 3/16EC	RHP	FU 0154-3	SFT25A	RHP	FU 0093-4	SLF 206	FYH	FU 0133-1	SLFL1EC	RHP	FU 0102-1

BY PART NUMBER

Part No.	Brand	Group No.	Part No.	Brand	Group No.	Part No.	Brand	Group No.	Part No.	Brand	Group No.
SLFL20A	RHP	FU 0047-2	UCF 204	SLB	FU 0044-1	UCF 207-20	FYH	FU 0162-1	UCF 210-30	KOYO	FU 0305-1
SLFL20EC	RHP	FU 0047-1	UCF 204	KOYO	FU 0044-1	UCF 207-20	NACHI	FU 0162-1	UCF 210-30	ASAHI	FU 0305-1
SLFL25A	RHP	FU 0088-2	UCF 204	ASAHI	FU 0044-1	UCF 207-20S	NSK	FU 0162-1	UCF 210-30	FYH	FU 0305-1
SLFL25EC	RHP	FU 0088-1	UCF 204	FYH	FU 0044-1	UCF 207-21	SLB	FU 0180-1	UCF 210-30	NACHI	FU 0305-1
SLFL3/4A	RHP	FU 0039-2	UCF 204	NACHI	FU 0044-1	UCF 207-21	KOYO	FU 0180-1	UCF 210-30S	NSK	FU 0305-1
SLFL3/4EC	RHP	FU 0039-1	UCF 204	NSK	FU 0044-1	UCF 207-21	ASAHI	FU 0180-1	UCF 210-31	SLB	FU 0314-1
SLFL30A	RHP	FU 0136-2	UCF 204-12	SLB	FU 0037-1	UCF 207-21	FYH	FU 0180-1	UCF 210-31	KOYO	FU 0314-1
SLFL30EC	RHP	FU 0136-1	UCF 204-12	KOYO	FU 0037-1	UCF 207-21	NACHI	FU 0180-1	UCF 210-31	ASAHI	FU 0314-1
SLFL5/8EC	RHP	FU 0022-1	UCF 204-12	ASAHI	FU 0037-1	UCF 207-22	SLB	FU 0191-1	UCF 210-31	FYH	FU 0314-1
SLFL7/8EC	RHP	FU 0066-1	UCF 204-12	FYH	FU 0037-1	UCF 207-22	KOYO	FU 0191-1	UCF 210-31	NACHI	FU 0314-1
UBF 204J	NSK	FU 0044-4	UCF 204-12	NACHI	FU 0037-1	UCF 207-22	ASAHI	FU 0191-1	UCF 210-32	SLB	FU 0335-1
UBF 205J	NSK	FU 0086-4	UCF 204-12S	NSK	FU 0037-1	UCF 207-22	FYH	FU 0191-1	UCF 211	SLB	FU 0368-1
UBF 206J	NSK	FU 0134-4	UCF 205	SLB	FU 0086-1	UCF 207-22	NACHI	FU 0191-1	UCF 211	KOYO	FU 0368-1
UBF 207J	NSK	FU 0202-4	UCF 205	KOYO	FU 0086-1	UCF 207-22S	NSK	FU 0191-1	UCF 211	ASAHI	FU 0368-1
UBFC 204J	NSK	FU 0048-4	UCF 205	ASAHI	FU 0086-1	UCF 207-23	SLB	FU 0216-1	UCF 211	FYH	FU 0368-1
UBFC 205J	NSK	FU 0092-4	UCF 205	FYH	FU 0086-1	UCF 207-23	KOYO	FU 0216-1	UCF 211	NACHI	FU 0368-1
UBFC 206J	NSK	FU 0140-4	UCF 205	NACHI	FU 0086-1	UCF 207-23	ASAHI	FU 0216-1	UCF 211	NSK	FU 0368-1
UBFC 207J	NSK	FU 0208-4	UCF 205	NSK	FU 0086-1	UCF 207-23	FYH	FU 0216-1	UCF 211-32	SLB	FU 0336-1
UBFL 204J	NSK	FU 0050-4	UCF 205-13	SLB	FU 0053-1	UCF 207-23	NACHI	FU 0216-1	UCF 211-32	KOYO	FU 0336-1
UBFL 205J	NSK	FU 0094-4	UCF 205-13	KOYO	FU 0053-1	UCF 208	SLB	FU 0246-1	UCF 211-32	ASAHI	FU 0336-1
UBFL 206J	NSK	FU 0143-4	UCF 205-14	SLB	FU 0064-1	UCF 208	ASAHI	FU 0246-1	UCF 211-32	FYH	FU 0336-1
UBFL 207J	NSK	FU 0211-4	UCF 205-14	KOYO	FU 0064-1	UCF 208	FYH	FU 0246-1	UCF 211-32	NACHI	FU 0336-1
UBPF 201	NSK	FU 0001-2	UCF 205-14	ASAHI	FU 0064-1	UCF 208	NACHI	FU 0246-1	UCF 211-32S	NSK	FU 0336-1
UBPF 202	NSK	FU 0016-2	UCF 205-14	FYH	FU 0064-1	UCF 208	NSK	FU 0246-1	UCF 211-33	SLB	FU 0352-1
UBPF 203	NSK	FU 0026-2	UCF 205-14	NACHI	FU 0064-1	UCF 208 B	KOYO	FU 0246-1	UCF 211-33	ASAHI	FU 0352-1
UBPF 204	NSK	FU 0046-2	UCF 205-14S	NSK	FU 0064-1	UCF 208-24	SLB	FU 0228-1	UCF 211-33	NACHI	FU 0352-1
UBPF 205	NSK	FU 0087-2	UCF 205-15	SLB	FU 0075-1	UCF 208-24	ASAHI	FU 0228-1	UCF 211-34	SLB	FU 0360-1
UBPF 206	NSK	FU 0135-2	UCF 205-15	KOYO	FU 0075-1	UCF 208-24	FYH	FU 0228-1	UCF 211-34	ASAHI	FU 0360-1
UBPF 207	NSK	FU 0203-2	UCF 205-15	ASAHI	FU 0075-1	UCF 208-24	NACHI	FU 0228-1	UCF 211-34	FYH	FU 0360-1
UBPFL 201	NSK	FU 0002-2	UCF 205-15	FYH	FU 0075-1	UCF 208-24 B	KOYO	FU 0228-1	UCF 211-34	NACHI	FU 0360-1
UBPFL 202	NSK	FU 0017-2	UCF 205-15	NACHI	FU 0075-1	UCF 208-24S	NSK	FU 0228-1	UCF 211-34S	NSK	FU 0360-1
UBPFL 203	NSK	FU 0027-2	UCF 205-16	SLB	FU 0100-1	UCF 208-25	SLB	FU 0237-1	UCF 211-35	SLB	FU 0379-1
UBPFL 204	NSK	FU 0047-2	UCF 205-16	KOYO	FU 0100-1	UCF 208-25	ASAHI	FU 0237-1	UCF 211-35	KOYO	FU 0379-1
UBPFL 205	NSK	FU 0088-2	UCF 205-16	ASAHI	FU 0100-1	UCF 208-25	FYH	FU 0237-1	UCF 211-35	ASAHI	FU 0379-1
UBPFL 206	NSK	FU 0136-2	UCF 205-16	FYH	FU 0100-1	UCF 208-25	NACHI	FU 0237-1	UCF 211-35	FYH	FU 0379-1
UBPFL 207	NSK	FU 0204-2	UCF 205-16	NACHI	FU 0100-1	UCF 208-25 B	KOYO	FU 0237-1	UCF 211-35	NACHI	FU 0379-1
UCF 201	SLB	FU 0003-1	UCF 205-16S	NSK	FU 0100-1	UCF 209	SLB	FU 0284-1	UCF 212	SLB	FU 0403-1
UCF 201	ASAHI	FU 0003-1	UCF 206	SLB	FU 0134-1	UCF 209	KOYO	FU 0284-1	UCF 212	KOYO	FU 0403-1
UCF 201	FYH	FU 0003-1	UCF 206	KOYO	FU 0134-1	UCF 209	ASAHI	FU 0284-1	UCF 212	ASAHI	FU 0403-1
UCF 201	NACHI	FU 0003-1	UCF 206	ASAHI	FU 0134-1	UCF 209	FYH	FU 0284-1	UCF 212	FYH	FU 0403-1
UCF 201	NSK	FU 0003-1	UCF 206	FYH	FU 0134-1	UCF 209	NACHI	FU 0284-1	UCF 212	NACHI	FU 0403-1
UCF 201-8	SLB	FU 0008-1	UCF 206	NACHI	FU 0134-1	UCF 209	NSK	FU 0284-1	UCF 212	NSK	FU 0403-1
UCF 201-8	ASAHI	FU 0008-1	UCF 206	NSK	FU 0134-1	UCF 209-26	SLB	FU 0257-1	UCF 212-36	SLB	FU 0387-1
UCF 201-8	FYH	FU 0008-1	UCF 206-17	SLB	FU 0112-1	UCF 209-26	KOYO	FU 0257-1	UCF 212-36	KOYO	FU 0387-1
UCF 201-8	NACHI	FU 0008-1	UCF 206-17	ASAHI	FU 0112-1	UCF 209-26	ASAHI	FU 0257-1	UCF 212-36	ASAHI	FU 0387-1
UCF 201-8S	NSK	FU 0008-1	UCF 206-17	NACHI	FU 0112-1	UCF 209-26	FYH	FU 0257-1	UCF 212-36	FYH	FU 0387-1
UCF 202	SLB	FU 0018-1	UCF 206-18	SLB	FU 0123-1	UCF 209-26	NACHI	FU 0257-1	UCF 212-36	NACHI	FU 0387-1
UCF 202	ASAHI	FU 0018-1	UCF 206-18	KOYO	FU 0123-1	UCF 209-26S	NSK	FU 0257-1	UCF 212-36S	NSK	FU 0387-1
UCF 202	FYH	FU 0018-1	UCF 206-18	ASAHI	FU 0123-1	UCF 209-27	SLB	FU 0266-1	UCF 212-37	SLB	FU 0395-1
UCF 202	NACHI	FU 0018-1	UCF 206-18	FYH	FU 0123-1	UCF 209-27	KOYO	FU 0266-1	UCF 212-38	SLB	FU 0414-1
UCF 202	NSK	FU 0018-1	UCF 206-18	NACHI	FU 0123-1	UCF 209-27	ASAHI	FU 0266-1	UCF 212-38	ASAHI	FU 0414-1
UCF 202-10	SLB	FU 0023-1	UCF 206-18S	NSK	FU 0123-1	UCF 209-27	FYH	FU 0266-1	UCF 212-38	FYH	FU 0414-1
UCF 202-10	ASAHI	FU 0023-1	UCF 206-19	SLB	FU 0148-1	UCF 209-27	NACHI	FU 0266-1	UCF 212-38	NACHI	FU 0414-1
UCF 202-10	FYH	FU 0023-1	UCF 206-19	KOYO	FU 0148-1	UCF 209-28	SLB	FU 0275-1	UCF 212-38S	NSK	FU 0414-1
UCF 202-10	NACHI	FU 0023-1	UCF 206-19	ASAHI	FU 0148-1	UCF 209-28	KOYO	FU 0275-1	UCF 212-39	SLB	FU 0422-1
UCF 202-10S	NSK	FU 0023-1	UCF 206-19	FYH	FU 0148-1	UCF 209-28	ASAHI	FU 0275-1	UCF 212-39	KOYO	FU 0422-1
UCF 202-9	SLB	FU 0013-1	UCF 206-19	NACHI	FU 0148-1	UCF 209-28	FYH	FU 0275-1	UCF 212-39	ASAHI	FU 0422-1
UCF 202-9	ASAHI	FU 0013-1	UCF 206-20	SLB	FU 0159-1	UCF 209-28	NACHI	FU 0275-1	UCF 212-39	FYH	FU 0422-1
UCF 202-9	NACHI	FU 0013-1	UCF 207	SLB	FU 0202-1	UCF 209-28S	NSK	FU 0275-1	UCF 212-39	NACHI	FU 0422-1
UCF 203	SLB	FU 0028-1	UCF 207	KOYO	FU 0202-1	UCF 210	SLB	FU 0323-1	UCF 213	SLB	FU 0438-1
UCF 203	ASAHI	FU 0028-1	UCF 207	ASAHI	FU 0202-1	UCF 210	KOYO	FU 0323-1	UCF 213	KOYO	FU 0438-1
UCF 203	FYH	FU 0028-1	UCF 207	FYH	FU 0202-1	UCF 210	ASAHI	FU 0323-1	UCF 213	ASAHI	FU 0438-1
UCF 203	NACHI	FU 0028-1	UCF 207	NACHI	FU 0202-1	UCF 210	FYH	FU 0323-1	UCF 213	FYH	FU 0438-1
UCF 203	NSK	FU 0028-1	UCF 207	NSK	FU 0202-1	UCF 210	NACHI	FU 0323-1	UCF 213	NACHI	FU 0438-1
UCF 203-11	SLB	FU 0033-1	UCF 207-20	SLB	FU 0162-1	UCF 210	NSK	FU 0323-1	UCF 213	NSK	FU 0438-1
UCF 203-11	ASAHI	FU 0033-1	UCF 207-20	KOYO	FU 0162-1	UCF 210-29	SLB	FU 0296-1	UCF 213-40	SLB	FU 0430-1
UCF 203-11	NACHI	FU 0033-1	UCF 207-20	ASAHI	FU 0162-1	UCF 210-30	SLB	FU 0305-1	UCF 213-40	KOYO	FU 0430-1

BY PART NUMBER

Part No.	Brand	Group No.	Part No.	Brand	Group No.	Part No.	Brand	Group No.	Part No.	Brand	Group No.
UCF 213-40	ASAHI	FU 0430-1	UCF 305-13	SLB	FU 0056-1	UCF 311	NSK	FU 0369-1	UCF 316-50	NACHI	FU 0529-1
UCF 213-40	FYH	FU 0430-1	UCF 305-14	SLB	FU 0067-1	UCF 311	SLB	FU 0369-1	UCF 316-50 S	NSK	FU 0529-1
UCF 213-40	NACHI	FU 0430-1	UCF 305-14	ASAHI	FU 0067-1	UCF 311	ASAHI	FU 0369-1	UCF X05	SLB	FU 0090-1
UCF 213-40S	NSK	FU 0430-1	UCF 305-14 S	NSK	FU 0067-1	UCF 311	FYH	FU 0369-1	UCF X05	ASAHI	FU 0090-1
UCF 213-41	SLB	FU 0446-1	UCF 305-15	SLB	FU 0078-1	UCF 311-32	SLB	FU 0340-1	UCF X05	FYH	FU 0090-1
UCF 214	SLB	FU 0478-1	UCF 305-16	SLB	FU 0103-1	UCF 311-32	ASAHI	FU 0340-1	UCF X05	NSK	FU 0090-1
UCF 214	ASAHI	FU 0478-1	UCF 305-16	ASAHI	FU 0103-1	UCF 311-32	FYH	FU 0340-1	UCF X05-13	SLB	FU 0057-1
UCF 214	FYH	FU 0478-1	UCF 305-16	FYH	FU 0103-1	UCF 311-32 S	NSK	FU 0340-1	UCF X05-14	SLB	FU 0068-1
UCF 214	NACHI	FU 0478-1	UCF 305-16 S	NSK	FU 0103-1	UCF 311-33	SLB	FU 0353-1	UCF X05-14	ASAHI	FU 0068-1
UCF 214	NSK	FU 0478-1	UCF 306	NSK	FU 0139-1	UCF 311-34	SLB	FU 0361-1	UCF X05-15	SLB	FU 0079-1
UCF 214-42	SLB	FU 0454-1	UCF 306	SLB	FU 0139-1	UCF 311-34	ASAHI	FU 0361-1	UCF X05-15	ASAHI	FU 0079-1
UCF 214-43	SLB	FU 0462-1	UCF 306	ASAHI	FU 0139-1	UCF 311-34 S	NSK	FU 0361-1	UCF X05-16	SLB	FU 0104-1
UCF 214-44	SLB	FU 0470-1	UCF 306	FYH	FU 0139-1	UCF 311-35	SLB	FU 0380-1	UCF X05-16	ASAHI	FU 0104-1
UCF 214-44	ASAHI	FU 0470-1	UCF 306-17	SLB	FU 0116-1	UCF 312	NSK	FU 0406-1	UCF X05-16	FYH	FU 0104-1
UCF 214-44	FYH	FU 0470-1	UCF 306-18	SLB	FU 0127-1	UCF 312	SLB	FU 0406-1	UCF X06	SLB	FU 0138-1
UCF 214-44	NACHI	FU 0470-1	UCF 306-18	ASAHI	FU 0127-1	UCF 312	ASAHI	FU 0406-1	UCF X06	ASAHI	FU 0138-1
UCF 214-44S	NSK	FU 0470-1	UCF 306-18	FYH	FU 0127-1	UCF 312	FYH	FU 0406-1	UCF X06	FYH	FU 0138-1
UCF 215	SLB	FU 0508-1	UCF 306-18 S	NSK	FU 0127-1	UCF 312-36	SLB	FU 0389-1	UCF X06	NSK	FU 0138-1
UCF 215	ASAHI	FU 0508-1	UCF 306-19	SLB	FU 0152-1	UCF 312-36	ASAHI	FU 0389-1	UCF X06-17	SLB	FU 0115-1
UCF 215	FYH	FU 0508-1	UCF 306-20	SLB	FU 0164-1	UCF 312-36 S	NSK	FU 0389-1	UCF X06-18	SLB	FU 0126-1
UCF 215	NACHI	FU 0508-1	UCF 306-20	FYH	FU 0164-1	UCF 312-37	SLB	FU 0397-1	UCF X06-18	ASAHI	FU 0126-1
UCF 215	NSK	FU 0508-1	UCF 307	NSK	FU 0205-1	UCF 312-38	SLB	FU 0416-1	UCF X06-19	SLB	FU 0151-1
UCF 215-45	SLB	FU 0487-1	UCF 307	SLB	FU 0205-1	UCF 312-38	ASAHI	FU 0416-1	UCF X06-19	ASAHI	FU 0151-1
UCF 215-46	SLB	FU 0494-1	UCF 307	ASAHI	FU 0205-1	UCF 312-38 S	NSK	FU 0416-1	UCF X06-19	FYH	FU 0151-1
UCF 215-47	SLB	FU 0501-1	UCF 307	FYH	FU 0205-1	UCF 312-39	SLB	FU 0424-1	UCF X06-20	SLB	FU 0163-1
UCF 215-48	SLB	FU 0515-1	UCF 307-20	SLB	FU 0168-1	UCF 313	NSK	FU 0440-1	UCF X06-20	ASAHI	FU 0163-1
UCF 215-48	ASAHI	FU 0515-1	UCF 307-20	ASAHI	FU 0168-1	UCF 313	SLB	FU 0440-1	UCF X06-20	FYH	FU 0163-1
UCF 215-48	FYH	FU 0515-1	UCF 307-20	FYH	FU 0168-1	UCF 313	ASAHI	FU 0440-1	UCF X07	SLB	FU 0206-1
UCF 215-48	NACHI	FU 0515-1	UCF 307-20 S	NSK	FU 0168-1	UCF 313	FYH	FU 0440-1	UCF X07	ASAHI	FU 0206-1
UCF 215-48S	NSK	FU 0515-1	UCF 307-21	SLB	FU 0183-1	UCF 313-40	SLB	FU 0432-1	UCF X07	FYH	FU 0206-1
UCF 216	SLB	FU 0533-1	UCF 307-22	SLB	FU 0194-1	UCF 313-40	ASAHI	FU 0432-1	UCF X07	NSK	FU 0206-1
UCF 216	ASAHI	FU 0533-1	UCF 307-22	ASAHI	FU 0194-1	UCF 313-40	FYH	FU 0432-1	UCF X07-20	SLB	FU 0169-1
UCF 216	FYH	FU 0533-1	UCF 307-22	FYH	FU 0194-1	UCF 313-40 S	NSK	FU 0432-1	UCF X07-20	FYH	FU 0169-1
UCF 216	NACHI	FU 0533-1	UCF 307-23	SLB	FU 0219-1	UCF 313-41	SLB	FU 0448-1	UCF X07-21	SLB	FU 0184-1
UCF 216	NSK	FU 0533-1	UCF 308	NSK	FU 0249-1	UCF 314	NSK	FU 0481-1	UCF X07-22	SLB	FU 0195-1
UCF 216-49	SLB	FU 0521-1	UCF 308	SLB	FU 0249-1	UCF 314	SLB	FU 0481-1	UCF X07-22	ASAHI	FU 0195-1
UCF 216-50	SLB	FU 0527-1	UCF 308	ASAHI	FU 0249-1	UCF 314	ASAHI	FU 0481-1	UCF X07-22	FYH	FU 0195-1
UCF 216-50	ASAHI	FU 0527-1	UCF 308	FYH	FU 0249-1	UCF 314	FYH	FU 0481-1	UCF X07-23	SLB	FU 0220-1
UCF 216-50	NACHI	FU 0527-1	UCF 308-24	SLB	FU 0230-1	UCF 314	NACHI	FU 0481-1	UCF X07-23	ASAHI	FU 0220-1
UCF 216-50S	NSK	FU 0527-1	UCF 308-24	ASAHI	FU 0230-1	UCF 314-42	SLB	FU 0457-1	UCF X07-23	FYH	FU 0220-1
UCF 216-51	SLB	FU 0539-1	UCF 308-24	FYH	FU 0230-1	UCF 314-43	SLB	FU 0465-1	UCF X08	SLB	FU 0248-1
UCF 217	SLB	FU 0548-1	UCF 308-24 S	NSK	FU 0230-1	UCF 314-44	SLB	FU 0473-1	UCF X08	ASAHI	FU 0248-1
UCF 217	ASAHI	FU 0548-1	UCF 308-25	SLB	FU 0239-1	UCF 314-44	ASAHI	FU 0473-1	UCF X08	FYH	FU 0248-1
UCF 217	FYH	FU 0548-1	UCF 309	NSK	FU 0287-1	UCF 314-44	FYH	FU 0473-1	UCF X08	NSK	FU 0248-1
UCF 217	NACHI	FU 0548-1	UCF 309	SLB	FU 0287-1	UCF 314-44	NACHI	FU 0473-1	UCF X08-24	SLB	FU 0229-1
UCF 217	NSK	FU 0548-1	UCF 309	ASAHI	FU 0287-1	UCF 314-44 S	NSK	FU 0473-1	UCF X08-24	ASAHI	FU 0229-1
UCF 217-52	SLB	FU 0542-1	UCF 309	FYH	FU 0287-1	UCF 315	NSK	FU 0510-1	UCF X08-24	FYH	FU 0229-1
UCF 217-52	ASAHI	FU 0542-1	UCF 309-26	SLB	FU 0259-1	UCF 315	SLB	FU 0510-1	UCF X08-25	SLB	FU 0238-1
UCF 217-52	FYH	FU 0542-1	UCF 309-26	ASAHI	FU 0259-1	UCF 315	ASAHI	FU 0510-1	UCF X09	NSK	FU 0286-1
UCF 217-52	NACHI	FU 0542-1	UCF 309-26 S	NSK	FU 0259-1	UCF 315	FYH	FU 0510-1	UCF X09	SLB	FU 0286-1
UCF 217-52S	NSK	FU 0542-1	UCF 309-27	SLB	FU 0268-1	UCF 315	NACHI	FU 0510-1	UCF X09	ASAHI	FU 0286-1
UCF 217-53	SLB	FU 0545-1	UCF 309-28	SLB	FU 0277-1	UCF 315-45	SLB	FU 0489-1	UCF X09	FYH	FU 0286-1
UCF 217-55	SLB	FU 0551-1	UCF 309-28	ASAHI	FU 0277-1	UCF 315-46	SLB	FU 0496-1	UCF X09-26	SLB	FU 0258-1
UCF 218	SLB	FU 0557-1	UCF 309-28	FYH	FU 0277-1	UCF 315-47	SLB	FU 0503-1	UCF X09-26	ASAHI	FU 0258-1
UCF 218	ASAHI	FU 0557-1	UCF 309-28 S	NSK	FU 0277-1	UCF 315-48	SLB	FU 0517-1	UCF X09-27	SLB	FU 0267-1
UCF 218	FYH	FU 0557-1	UCF 310	NSK	FU 0326-1	UCF 315-48	ASAHI	FU 0517-1	UCF X09-27	ASAHI	FU 0267-1
UCF 218	NACHI	FU 0557-1	UCF 310	SLB	FU 0326-1	UCF 315-48	FYH	FU 0517-1	UCF X09-27	FYH	FU 0267-1
UCF 218	NSK	FU 0557-1	UCF 310	ASAHI	FU 0326-1	UCF 315-48	NACHI	FU 0517-1	UCF X09-28	SLB	FU 0276-1
UCF 218-56	SLB	FU 0554-1	UCF 310	FYH	FU 0326-1	UCF 315-48 S	NSK	FU 0517-1	UCF X09-28	ASAHI	FU 0276-1
UCF 218-56	ASAHI	FU 0554-1	UCF 310-29	SLB	FU 0298-1	UCF 316	NSK	FU 0535-1	UCF X09-28	FYH	FU 0276-1
UCF 218-56	FYH	FU 0554-1	UCF 310-30	SLB	FU 0307-1	UCF 316	SLB	FU 0535-1	UCF X10	NSK	FU 0325-1
UCF 218-56	NACHI	FU 0554-1	UCF 310-30	ASAHI	FU 0307-1	UCF 316	ASAHI	FU 0535-1	UCF X10	SLB	FU 0325-1
UCF 218-56S	NSK	FU 0554-1	UCF 310-30 S	NSK	FU 0307-1	UCF 316	FYH	FU 0535-1	UCF X10	ASAHI	FU 0325-1
UCF 305	NSK	FU 0089-1	UCF 310-31	FYH	FU 0316-1	UCF 316	NACHI	FU 0535-1	UCF X10	FYH	FU 0325-1
UCF 305	SLB	FU 0089-1	UCF 310-31	SLB	FU 0316-1	UCF 316-49	SLB	FU 0523-1	UCF X10-29	SLB	FU 0297-1
UCF 305	ASAHI	FU 0089-1	UCF 310-32	SLB	FU 0338-1	UCF 316-50	SLB	FU 0529-1	UCF X10-30	SLB	FU 0306-1
UCF 305	FYH	FU 0089-1	UCF 310-32	FYH	FU 0338-1	UCF 316-50	ASAHI	FU 0529-1	UCF X10-30	ASAHI	FU 0306-1

BY PART NUMBER

Part No.	Brand	Group No.	Part No.	Brand	Group No.	Part No.	Brand	Group No.	Part No.	Brand	Group No.
UCF X10-31	SLB	FU 0315-1	UCF X16	NSK	FU 0534-1	UCF216-303D1	NTN	FU 0539-1	UCFC 201-8S	NSK	FU 0009-1
UCF X10-31	ASAHI	FU 0315-1	UCF X16	SLB	FU 0534-1	UCF216D1	NTN	FU 0533-1	UCFC 202	SLB	FU 0019-1
UCF X10-31	FYH	FU 0315-1	UCF X16	ASAHI	FU 0534-1	UCF217-304D1	NTN	FU 0542-1	UCFC 202	ASAHI	FU 0019-1
UCF X10-32	SLB	FU 0337-1	UCF X16	FYH	FU 0534-1	UCF217-305D1	NTN	FU 0545-1	UCFC 202	FYH	FU 0019-1
UCF X10-32	ASAHI	FU 0337-1	UCF X16	NACHI	FU 0534-1	UCF217-307D1	NTN	FU 0551-1	UCFC 202	NACHI	FU 0019-1
UCF X10-32	FYH	FU 0337-1	UCF X16-49	SLB	FU 0522-1	UCF217D1	NTN	FU 0548-1	UCFC 202	NSK	FU 0019-1
UCF X11	NSK	FU 0371-1	UCF X16-50	SLB	FU 0528-1	UCF218-308D1	NTN	FU 0554-1	UCFC 202-10	SLB	FU 0024-1
UCF X11	SLB	FU 0371-1	UCF201-008D1	NTN	FU 0008-1	UCF218D1	NTN	FU 0557-1	UCFC 202-10	ASAHI	FU 0024-1
UCF X11	ASAHI	FU 0371-1	UCF201D1	NTN	FU 0003-1	UCF305-013D1	NTN	FU 0056-1	UCFC 202-10	FYH	FU 0024-1
UCF X11	FYH	FU 0371-1	UCF202-009D1	NTN	FU 0013-1	UCF305-014D1	NTN	FU 0067-1	UCFC 202-10	NACHI	FU 0024-1
UCF X11-32	SLB	FU 0341-1	UCF202-010D1	NTN	FU 0023-1	UCF305-015D1	NTN	FU 0078-1	UCFC 202-10S	NSK	FU 0024-1
UCF X11-33	SLB	FU 0354-1	UCF202D1	NTN	FU 0018-1	UCF305-100D1	NTN	FU 0103-1	UCFC 202-9	SLB	FU 0014-1
UCF X11-34	SLB	FU 0362-1	UCF203-011D1	NTN	FU 0033-1	UCF305D1	NTN	FU 0089-1	UCFC 202-9	ASAHI	FU 0014-1
UCF X11-34	ASAHI	FU 0362-1	UCF203D1	NTN	FU 0028-1	UCF306-101D1	NTN	FU 0116-1	UCFC 202-9	NACHI	FU 0014-1
UCF X11-35	SLB	FU 0381-1	UCF204-012D1	NTN	FU 0037-1	UCF306-102D1	NTN	FU 0127-1	UCFC 203	SLB	FU 0029-1
UCF X11-35	ASAHI	FU 0381-1	UCF204D1	NTN	FU 0044-1	UCF306-103D1	NTN	FU 0152-1	UCFC 203	ASAHI	FU 0029-1
UCF X11-35	FYH	FU 0381-1	UCF205-013D1	NTN	FU 0053-1	UCF306D1	NTN	FU 0139-1	UCFC 203	FYH	FU 0029-1
UCF X12	NSK	FU 0405-1	UCF205-014D1	NTN	FU 0064-1	UCF307-104D1	NTN	FU 0168-1	UCFC 203	NACHI	FU 0029-1
UCF X12	SLB	FU 0405-1	UCF205-015D1	NTN	FU 0075-1	UCF307-105D1	NTN	FU 0183-1	UCFC 203	NSK	FU 0029-1
UCF X12	ASAHI	FU 0405-1	UCF205-100D1	NTN	FU 0100-1	UCF307-106D1	NTN	FU 0194-1	UCFC 203-11	SLB	FU 0034-1
UCF X12	FYH	FU 0405-1	UCF205D1	NTN	FU 0086-1	UCF307-107D1	NTN	FU 0219-1	UCFC 203-11	ASAHI	FU 0034-1
UCF X12-36	SLB	FU 0388-1	UCF206-101D1	NTN	FU 0112-1	UCF307D1	NTN	FU 0205-1	UCFC 203-11	NACHI	FU 0034-1
UCF X12-36	ASAHI	FU 0388-1	UCF206-102D1	NTN	FU 0123-1	UCF308-108D1	NTN	FU 0230-1	UCFC 204	SLB	FU 0048-1
UCF X12-36	FYH	FU 0388-1	UCF206-103D1	NTN	FU 0148-1	UCF308-109D1	NTN	FU 0239-1	UCFC 204	ASAHI	FU 0048-1
UCF X12-37	SLB	FU 0396-1	UCF206-104D1	NTN	FU 0159-1	UCF308D1	NTN	FU 0249-1	UCFC 204	FYH	FU 0048-1
UCF X12-37	FYH	FU 0396-1	UCF206D1	NTN	FU 0134-1	UCF309-110D1	NTN	FU 0259-1	UCFC 204	NACHI	FU 0048-1
UCF X12-38	SLB	FU 0415-1	UCF207-104D1	NTN	FU 0162-1	UCF309-111D1	NTN	FU 0268-1	UCFC 204	NSK	FU 0048-1
UCF X12-38	ASAHI	FU 0415-1	UCF207-105D1	NTN	FU 0180-1	UCF309-112D1	NTN	FU 0277-1	UCFC 204-12	SLB	FU 0040-1
UCF X12-38	FYH	FU 0415-1	UCF207-106D1	NTN	FU 0191-1	UCF309D1	NTN	FU 0287-1	UCFC 204-12	ASAHI	FU 0040-1
UCF X12-39	SLB	FU 0423-1	UCF207-107D1	NTN	FU 0216-1	UCF310-113D1	NTN	FU 0298-1	UCFC 204-12	FYH	FU 0040-1
UCF X12-39	ASAHI	FU 0423-1	UCF207D1	NTN	FU 0202-1	UCF310-114D1	NTN	FU 0307-1	UCFC 204-12	NACHI	FU 0040-1
UCF X12-39	FYH	FU 0423-1	UCF208-108D1	NTN	FU 0228-1	UCF310-115D1	NTN	FU 0316-1	UCFC 204-12S	NSK	FU 0040-1
UCF X13	NSK	FU 0439-1	UCF208-109D1	NTN	FU 0237-1	UCF310D1	NTN	FU 0326-1	UCFC 205	SLB	FU 0092-1
UCF X13	SLB	FU 0439-1	UCF208D1	NTN	FU 0246-1	UCF311-200D1	NTN	FU 0340-1	UCFC 205	ASAHI	FU 0092-1
UCF X13	ASAHI	FU 0439-1	UCF209-110D1	NTN	FU 0257-1	UCF311-201D1	NTN	FU 0353-1	UCFC 205	FYH	FU 0092-1
UCF X13	FYH	FU 0439-1	UCF209-111D1	NTN	FU 0266-1	UCF311-202D1	NTN	FU 0361-1	UCFC 205	NACHI	FU 0092-1
UCF X13-40	SLB	FU 0431-1	UCF209-112D1	NTN	FU 0275-1	UCF311-203D1	NTN	FU 0380-1	UCFC 205	NSK	FU 0092-1
UCF X13-40	ASAHI	FU 0431-1	UCF209D1	NTN	FU 0284-1	UCF311D1	NTN	FU 0369-1	UCFC 205-13	SLB	FU 0058-1
UCF X13-40	FYH	FU 0431-1	UCF210-113D1	NTN	FU 0296-1	UCF312-204D1	NTN	FU 0389-1	UCFC 205-14	SLB	FU 0069-1
UCF X13-41	SLB	FU 0447-1	UCF210-114D1	NTN	FU 0305-1	UCF312-205D1	NTN	FU 0397-1	UCFC 205-14	ASAHI	FU 0069-1
UCF X14	NSK	FU 0479-1	UCF210-115D1	NTN	FU 0314-1	UCF312-206D1	NTN	FU 0416-1	UCFC 205-14	FYH	FU 0069-1
UCF X14	SLB	FU 0479-1	UCF210-200D1	NTN	FU 0335-1	UCF312-207D1	NTN	FU 0424-1	UCFC 205-14	NACHI	FU 0069-1
UCF X14	ASAHI	FU 0479-1	UCF210D1	NTN	FU 0323-1	UCF312D1	NTN	FU 0406-1	UCFC 205-14S	NSK	FU 0069-1
UCF X14	FYH	FU 0479-1	UCF211-200D1	NTN	FU 0336-1	UCF313-208D1	NTN	FU 0432-1	UCFC 205-15	SLB	FU 0080-1
UCF X14	NACHI	FU 0479-1	UCF211-201D1	NTN	FU 0352-1	UCF313-209D1	NTN	FU 0448-1	UCFC 205-15	ASAHI	FU 0080-1
UCF X14-42	SLB	FU 0455-1	UCF211-202D1	NTN	FU 0360-1	UCF313D1	NTN	FU 0440-1	UCFC 205-15	FYH	FU 0080-1
UCF X14-43	SLB	FU 0463-1	UCF211-203D1	NTN	FU 0379-1	UCF314-210D1	NTN	FU 0457-1	UCFC 205-15	NACHI	FU 0080-1
UCF X14-43	ASAHI	FU 0463-1	UCF211D1	NTN	FU 0368-1	UCF314-211D1	NTN	FU 0465-1	UCFC 205-16	SLB	FU 0105-1
UCF X14-43	NACHI	FU 0463-1	UCF212-204D1	NTN	FU 0387-1	UCF314-212D1	NTN	FU 0473-1	UCFC 205-16	ASAHI	FU 0105-1
UCF X14-44	SLB	FU 0471-1	UCF212-205D1	NTN	FU 0395-1	UCF314D1	NTN	FU 0481-1	UCFC 205-16	FYH	FU 0105-1
UCF X14-44	ASAHI	FU 0471-1	UCF212-206D1	NTN	FU 0414-1	UCF315-213D1	NTN	FU 0489-1	UCFC 205-16	NACHI	FU 0105-1
UCF X14-44	FYH	FU 0471-1	UCF212-207D1	NTN	FU 0422-1	UCF315-214D1	NTN	FU 0496-1	UCFC 205-16S	NSK	FU 0105-1
UCF X14-44	NACHI	FU 0471-1	UCF212D1	NTN	FU 0403-1	UCF315-215D1	NTN	FU 0503-1	UCFC 206	SLB	FU 0140-1
UCF X15	NSK	FU 0507-1	UCF213-208D1	NTN	FU 0430-1	UCF315-300D1	NTN	FU 0517-1	UCFC 206	ASAHI	FU 0140-1
UCF X15	SLB	FU 0507-1	UCF213-209D1	NTN	FU 0446-1	UCF315D1	NTN	FU 0510-1	UCFC 206	FYH	FU 0140-1
UCF X15	ASAHI	FU 0507-1	UCF213D1	NTN	FU 0438-1	UCF316-301D1	NTN	FU 0523-1	UCFC 206	NACHI	FU 0140-1
UCF X15	FYH	FU 0507-1	UCF214-210D1	NTN	FU 0454-1	UCF316-302D1	NTN	FU 0529-1	UCFC 206	NSK	FU 0140-1
UCF X15	NACHI	FU 0507-1	UCF214-211D1	NTN	FU 0462-1	UCF316D1	NTN	FU 0535-1	UCFC 206-17	SLB	FU 0117-1
UCF X15-45	SLB	FU 0486-1	UCF214-212D1	NTN	FU 0470-1	UCFC 201	SLB	FU 0004-1	UCFC 206-17	ASAHI	FU 0117-1
UCF X15-46	SLB	FU 0493-1	UCF214D1	NTN	FU 0478-1	UCFC 201	ASAHI	FU 0004-1	UCFC 206-17	NACHI	FU 0117-1
UCF X15-47	SLB	FU 0500-1	UCF215-213D1	NTN	FU 0487-1	UCFC 201	FYH	FU 0004-1	UCFC 206-18	SLB	FU 0128-1
UCF X15-47	ASAHI	FU 0500-1	UCF215-214D1	NTN	FU 0494-1	UCFC 201	NACHI	FU 0004-1	UCFC 206-18	ASAHI	FU 0128-1
UCF X15-47	NACHI	FU 0500-1	UCF215-215D1	NTN	FU 0501-1	UCFC 201	NSK	FU 0004-1	UCFC 206-18	FYH	FU 0128-1
UCF X15-48	SLB	FU 0514-1	UCF215-300D1	NTN	FU 0515-1	UCFC 201-8	SLB	FU 0009-1	UCFC 206-18	NACHI	FU 0128-1
UCF X15-48	ASAHI	FU 0514-1	UCF215D1	NTN	FU 0508-1	UCFC 201-8	ASAHI	FU 0009-1	UCFC 206-18S	NSK	FU 0128-1
UCF X15-48	FYH	FU 0514-1	UCF216-301D1	NTN	FU 0521-1	UCFC 201-8	FYH	FU 0009-1	UCFC 206-19	SLB	FU 0153-1
UCF X15-48	NACHI	FU 0514-1	UCF216-302D1	NTN	FU 0527-1	UCFC 201-8	NACHI	FU 0009-1	UCFC 206-19	ASAHI	FU 0153-1

BY PART NUMBER

Part No.	Brand	Group No.	Part No.	Brand	Group No.	Part No.	Brand	Group No.	Part No.	Brand	Group No.
UCFC 206-19	FYH	FU 0153-1	UCFC 210-30	FYH	FU 0308-1	UCFC 214-43	SLB	FU 0464-1	UCFC206-102D1	NTN	FU 0128-1
UCFC 206-19	NACHI	FU 0153-1	UCFC 210-30	NACHI	FU 0308-1	UCFC 214-44	SLB	FU 0472-1	UCFC206-103D1	NTN	FU 0153-1
UCFC 206-20	SLB	FU 0167-1	UCFC 210-30S	NSK	FU 0308-1	UCFC 214-44	ASAHI	FU 0472-1	UCFC206-104D1	NTN	FU 0167-1
UCFC 207	SLB	FU 0208-1	UCFC 210-31	SLB	FU 0317-1	UCFC 214-44	FYH	FU 0472-1	UCFC206D1	NTN	FU 0140-1
UCFC 207	ASAHI	FU 0208-1	UCFC 210-31	ASAHI	FU 0317-1	UCFC 214-44	NACHI	FU 0472-1	UCFC207-104D1	NTN	FU 0170-1
UCFC 207	FYH	FU 0208-1	UCFC 210-31	FYH	FU 0317-1	UCFC 214-44S	NSK	FU 0472-1	UCFC207-105D1	NTN	FU 0185-1
UCFC 207	NACHI	FU 0208-1	UCFC 210-31	NACHI	FU 0317-1	UCFC 215	SLB	FU 0509-1	UCFC207-106D1	NTN	FU 0196-1
UCFC 207	NSK	FU 0208-1	UCFC 210-32	NSK	FU 0339-1	UCFC 215	ASAHI	FU 0509-1	UCFC207-107D1	NTN	FU 0221-1
UCFC 207-20	SLB	FU 0170-1	UCFC 211	SLB	FU 0372-1	UCFC 215	FYH	FU 0509-1	UCFC207D1	NTN	FU 0208-1
UCFC 207-20	ASAHI	FU 0170-1	UCFC 211	ASAHI	FU 0372-1	UCFC 215	NACHI	FU 0509-1	UCFC208-108D1	NTN	FU 0231-1
UCFC 207-20	FYH	FU 0170-1	UCFC 211	FYH	FU 0372-1	UCFC 215	NSK	FU 0509-1	UCFC208-109D1	NTN	FU 0240-1
UCFC 207-20	NACHI	FU 0170-1	UCFC 211	NACHI	FU 0372-1	UCFC 215-45	SLB	FU 0488-1	UCFC208D1	NTN	FU 0250-1
UCFC 207-20S	NSK	FU 0170-1	UCFC 211	NSK	FU 0372-1	UCFC 215-46	SLB	FU 0495-1	UCFC209-110D1	NTN	FU 0260-1
UCFC 207-21	SLB	FU 0185-1	UCFC 211-32	SLB	FU 0342-1	UCFC 215-47	SLB	FU 0502-1	UCFC209-111D1	NTN	FU 0269-1
UCFC 207-21	ASAHI	FU 0185-1	UCFC 211-32	ASAHI	FU 0342-1	UCFC 215-48	SLB	FU 0516-1	UCFC209-112D1	NTN	FU 0278-1
UCFC 207-21	FYH	FU 0185-1	UCFC 211-32	FYH	FU 0342-1	UCFC 215-48	ASAHI	FU 0516-1	UCFC209D1	NTN	FU 0288-1
UCFC 207-21	NACHI	FU 0185-1	UCFC 211-32	NACHI	FU 0342-1	UCFC 215-48	FYH	FU 0516-1	UCFC210-113D1	NTN	FU 0299-1
UCFC 207-22	SLB	FU 0196-1	UCFC 211-32S	NSK	FU 0342-1	UCFC 215-48	NACHI	FU 0516-1	UCFC210-114D1	NTN	FU 0308-1
UCFC 207-22	ASAHI	FU 0196-1	UCFC 211-33	SLB	FU 0355-1	UCFC 215-48S	NSK	FU 0516-1	UCFC210-115D1	NTN	FU 0317-1
UCFC 207-22	FYH	FU 0196-1	UCFC 211-33	ASAHI	FU 0355-1	UCFC 216	SLB	FU 0536-1	UCFC210-200D1	NTN	FU 0339-1
UCFC 207-22	NACHI	FU 0196-1	UCFC 211-33	NACHI	FU 0355-1	UCFC 216	ASAHI	FU 0536-1	UCFC210D1	NTN	FU 0327-1
UCFC 207-22S	NSK	FU 0196-1	UCFC 211-34	SLB	FU 0363-1	UCFC 216	FYH	FU 0536-1	UCFC211-200D1	NTN	FU 0342-1
UCFC 207-23	SLB	FU 0221-1	UCFC 211-34	ASAHI	FU 0363-1	UCFC 216	NACHI	FU 0536-1	UCFC211-201D1	NTN	FU 0355-1
UCFC 207-23	ASAHI	FU 0221-1	UCFC 211-34	FYH	FU 0363-1	UCFC 216	NSK	FU 0536-1	UCFC211-202D1	NTN	FU 0363-1
UCFC 207-23	FYH	FU 0221-1	UCFC 211-34	NACHI	FU 0363-1	UCFC 216-49	SLB	FU 0524-1	UCFC211-203D1	NTN	FU 0382-1
UCFC 207-23	NACHI	FU 0221-1	UCFC 211-34S	NSK	FU 0363-1	UCFC 216-50	SLB	FU 0530-1	UCFC211D1	NTN	FU 0372-1
UCFC 208	SLB	FU 0250-1	UCFC 211-35	SLB	FU 0382-1	UCFC 216-50	ASAHI	FU 0530-1	UCFC212-204D1	NTN	FU 0390-1
UCFC 208	ASAHI	FU 0250-1	UCFC 211-35	ASAHI	FU 0382-1	UCFC 216-50	NACHI	FU 0530-1	UCFC212-205D1	NTN	FU 0398-1
UCFC 208	FYH	FU 0250-1	UCFC 211-35	FYH	FU 0382-1	UCFC 216-50S	NSK	FU 0530-1	UCFC212-206D1	NTN	FU 0417-1
UCFC 208	NACHI	FU 0250-1	UCFC 211-35	NACHI	FU 0382-1	UCFC 216-51	SLB	FU 0540-1	UCFC212-207D1	NTN	FU 0425-1
UCFC 208	NSK	FU 0250-1	UCFC 212	SLB	FU 0407-1	UCFC 217	SLB	FU 0549-1	UCFC212D1	NTN	FU 0407-1
UCFC 208-24	SLB	FU 0231-1	UCFC 212	ASAHI	FU 0407-1	UCFC 217	ASAHI	FU 0549-1	UCFC213-208D1	NTN	FU 0433-1
UCFC 208-24	ASAHI	FU 0231-1	UCFC 212	FYH	FU 0407-1	UCFC 217	FYH	FU 0549-1	UCFC213-209D1	NTN	FU 0449-1
UCFC 208-24	FYH	FU 0231-1	UCFC 212	NACHI	FU 0407-1	UCFC 217	NACHI	FU 0549-1	UCFC213D1	NTN	FU 0441-1
UCFC 208-24	NACHI	FU 0231-1	UCFC 212	NSK	FU 0407-1	UCFC 217	NSK	FU 0549-1	UCFC214-210D1	NTN	FU 0456-1
UCFC 208-24S	NSK	FU 0231-1	UCFC 212-36	SLB	FU 0390-1	UCFC 217-52	SLB	FU 0543-1	UCFC214-211D1	NTN	FU 0464-1
UCFC 208-25	SLB	FU 0240-1	UCFC 212-36	ASAHI	FU 0390-1	UCFC 217-52	ASAHI	FU 0543-1	UCFC214-212D1	NTN	FU 0472-1
UCFC 208-25	ASAHI	FU 0240-1	UCFC 212-36	FYH	FU 0390-1	UCFC 217-52	FYH	FU 0543-1	UCFC214D1	NTN	FU 0480-1
UCFC 208-25	FYH	FU 0240-1	UCFC 212-36	NACHI	FU 0390-1	UCFC 217-52	NACHI	FU 0543-1	UCFC215-213D1	NTN	FU 0488-1
UCFC 208-25	NACHI	FU 0240-1	UCFC 212-36S	NSK	FU 0390-1	UCFC 217-52S	NSK	FU 0543-1	UCFC215-214D1	NTN	FU 0495-1
UCFC 209	SLB	FU 0288-1	UCFC 212-37	SLB	FU 0398-1	UCFC 217-53	SLB	FU 0546-1	UCFC215-215D1	NTN	FU 0502-1
UCFC 209	ASAHI	FU 0288-1	UCFC 212-38	SLB	FU 0417-1	UCFC 217-55	SLB	FU 0552-1	UCFC215-300D1	NTN	FU 0516-1
UCFC 209	FYH	FU 0288-1	UCFC 212-38	ASAHI	FU 0417-1	UCFC 218	SLB	FU 0558-1	UCFC215D1	NTN	FU 0509-1
UCFC 209	NACHI	FU 0288-1	UCFC 212-38	FYH	FU 0417-1	UCFC 218	ASAHI	FU 0558-1	UCFC216-301D1	NTN	FU 0524-1
UCFC 209	NSK	FU 0288-1	UCFC 212-38	NACHI	FU 0417-1	UCFC 218	FYH	FU 0558-1	UCFC216-302D1	NTN	FU 0530-1
UCFC 209-26	SLB	FU 0260-1	UCFC 212-38S	NSK	FU 0417-1	UCFC 218	NACHI	FU 0558-1	UCFC216-303D1	NTN	FU 0540-1
UCFC 209-26	ASAHI	FU 0260-1	UCFC 212-39	SLB	FU 0425-1	UCFC 218	NSK	FU 0558-1	UCFC216D1	NTN	FU 0536-1
UCFC 209-26	FYH	FU 0260-1	UCFC 212-39	ASAHI	FU 0425-1	UCFC 218-56	SLB	FU 0555-1	UCFC217-304D1	NTN	FU 0543-1
UCFC 209-26	NACHI	FU 0260-1	UCFC 212-39	FYH	FU 0425-1	UCFC 218-56	ASAHI	FU 0555-1	UCFC217-305D1	NTN	FU 0546-1
UCFC 209-26S	NSK	FU 0260-1	UCFC 212-39	NACHI	FU 0425-1	UCFC 218-56	FYH	FU 0555-1	UCFC217-307D1	NTN	FU 0552-1
UCFC 209-27	SLB	FU 0269-1	UCFC 213	SLB	FU 0441-1	UCFC 218-56	NACHI	FU 0555-1	UCFC217D1	NTN	FU 0549-1
UCFC 209-27	ASAHI	FU 0269-1	UCFC 213	ASAHI	FU 0441-1	UCFC 218-56S	NSK	FU 0555-1	UCFC218-308D1	NTN	FU 0555-1
UCFC 209-27	FYH	FU 0269-1	UCFC 213	FYH	FU 0441-1	UCFC201-008D1	NTN	FU 0009-1	UCFC218D1	NTN	FU 0558-1
UCFC 209-27	NACHI	FU 0269-1	UCFC 213	NACHI	FU 0441-1	UCFC201D1	NTN	FU 0004-1	UCFL 201	SLB	FU 0005-1
UCFC 209-28	SLB	FU 0278-1	UCFC 213	NSK	FU 0441-1	UCFC202-009D1	NTN	FU 0014-1	UCFL 201	ASAHI	FU 0005-1
UCFC 209-28	ASAHI	FU 0278-1	UCFC 213-40	SLB	FU 0433-1	UCFC202-010D1	NTN	FU 0024-1	UCFL 201	FYH	FU 0005-1
UCFC 209-28	FYH	FU 0278-1	UCFC 213-40	ASAHI	FU 0433-1	UCFC202D1	NTN	FU 0019-1	UCFL 201	NACHI	FU 0005-1
UCFC 209-28	NACHI	FU 0278-1	UCFC 213-40	FYH	FU 0433-1	UCFC203-011D1	NTN	FU 0034-1	UCFL 201-8	SLB	FU 0010-1
UCFC 209-28S	NSK	FU 0278-1	UCFC 213-40	NACHI	FU 0433-1	UCFC203D1	NTN	FU 0029-1	UCFL 201-8	ASAHI	FU 0010-1
UCFC 210	SLB	FU 0327-1	UCFC 213-40S	NSK	FU 0433-1	UCFC204-012D1	NTN	FU 0040-1	UCFL 201-8	FYH	FU 0010-1
UCFC 210	ASAHI	FU 0327-1	UCFC 213-41	SLB	FU 0449-1	UCFC204D1	NTN	FU 0048-1	UCFL 201-8	NACHI	FU 0010-1
UCFC 210	FYH	FU 0327-1	UCFC 214	SLB	FU 0480-1	UCFC205-013D1	NTN	FU 0058-1	UCFL 202	SLB	FU 0020-1
UCFC 210	NACHI	FU 0327-1	UCFC 214	ASAHI	FU 0480-1	UCFC205-014D1	NTN	FU 0069-1	UCFL 202	ASAHI	FU 0020-1
UCFC 210	NSK	FU 0327-1	UCFC 214	FYH	FU 0480-1	UCFC205-015D1	NTN	FU 0080-1	UCFL 202	FYH	FU 0020-1
UCFC 210-29	SLB	FU 0299-1	UCFC 214	NACHI	FU 0480-1	UCFC205-100D1	NTN	FU 0105-1	UCFL 202	NACHI	FU 0020-1
UCFC 210-30	SLB	FU 0308-1	UCFC 214	NSK	FU 0480-1	UCFC205D1	NTN	FU 0092-1	UCFL 202-10	SLB	FU 0025-1
UCFC 210-30	ASAHI	FU 0308-1	UCFC 214-42	SLB	FU 0456-1	UCFC206-101D1	NTN	FU 0117-1	UCFL 202-10	ASAHI	FU 0025-1

BY PART NUMBER

Part No.	Brand	Group No.	Part No.	Brand	Group No.	Part No.	Brand	Group No.	Part No.	Brand	Group No.
UCFL 202-10	FYH	FU 0025-1	UCFL 207 B	KOYO	FU 0211-1	UCFL 210-31	SLB	FU 0319-1	UCFL 215-47	SLB	FU 0504-1
UCFL 202-10	NACHI	FU 0025-1	UCFL 207-20	SLB	FU 0174-1	UCFL 210-31	KOYO	FU 0319-1	UCFL 215-48	SLB	FU 0518-1
UCFL 202-9	SLB	FU 0015-1	UCFL 207-20	ASAHI	FU 0174-1	UCFL 210-31	ASAHI	FU 0319-1	UCFL 215-48	ASAHI	FU 0518-1
UCFL 202-9	ASAHI	FU 0015-1	UCFL 207-20	FYH	FU 0174-1	UCFL 210-31	FYH	FU 0319-1	UCFL 215-48	FYH	FU 0518-1
UCFL 202-9	NACHI	FU 0015-1	UCFL 207-20	NACHI	FU 0174-1	UCFL 210-31	NACHI	FU 0319-1	UCFL 215-48	NACHI	FU 0518-1
UCFL 203	SLB	FU 0030-1	UCFL 207-20 B	KOYO	FU 0174-1	UCFL 210-32	SLB	FU 0344-1	UCFL 216	SLB	FU 0537-1
UCFL 203	ASAHI	FU 0030-1	UCFL 207-21	SLB	FU 0187-1	UCFL 211	SLB	FU 0375-1	UCFL 216	ASAHI	FU 0537-1
UCFL 203	FYH	FU 0030-1	UCFL 207-21	ASAHI	FU 0187-1	UCFL 211	ASAHI	FU 0375-1	UCFL 216	FYH	FU 0537-1
UCFL 203	NACHI	FU 0030-1	UCFL 207-21	FYH	FU 0187-1	UCFL 211	FYH	FU 0375-1	UCFL 216	NACHI	FU 0537-1
UCFL 203-11	SLB	FU 0035-1	UCFL 207-21	NACHI	FU 0187-1	UCFL 211	NACHI	FU 0375-1	UCFL 216-49	SLB	FU 0525-1
UCFL 203-11	ASAHI	FU 0035-1	UCFL 207-21 B	KOYO	FU 0187-1	UCFL 211-32	SLB	FU 0346-1	UCFL 216-50	SLB	FU 0531-1
UCFL 203-11	NACHI	FU 0035-1	UCFL 207-22	SLB	FU 0198-1	UCFL 211-32	ASAHI	FU 0346-1	UCFL 216-50	ASAHI	FU 0531-1
UCFL 204	SLB	FU 0050-1	UCFL 207-22	ASAHI	FU 0198-1	UCFL 211-32	FYH	FU 0346-1	UCFL 216-50	NACHI	FU 0531-1
UCFL 204	KOYO	FU 0050-1	UCFL 207-22	FYH	FU 0198-1	UCFL 211-32	NACHI	FU 0346-1	UCFL 216-51	SLB	FU 0541-1
UCFL 204	ASAHI	FU 0050-1	UCFL 207-22	NACHI	FU 0198-1	UCFL 211-33	SLB	FU 0357-1	UCFL 217	SLB	FU 0550-1
UCFL 204	FYH	FU 0050-1	UCFL 207-22 B	KOYO	FU 0198-1	UCFL 211-33	ASAHI	FU 0357-1	UCFL 217	ASAHI	FU 0550-1
UCFL 204	NACHI	FU 0050-1	UCFL 207-23	SLB	FU 0223-1	UCFL 211-33	NACHI	FU 0357-1	UCFL 217	FYH	FU 0550-1
UCFL 204-12	SLB	FU 0042-1	UCFL 207-23	ASAHI	FU 0223-1	UCFL 211-34	SLB	FU 0365-1	UCFL 217	NACHI	FU 0550-1
UCFL 204-12	KOYO	FU 0042-1	UCFL 207-23	FYH	FU 0223-1	UCFL 211-34	ASAHI	FU 0365-1	UCFL 217-52	SLB	FU 0544-1
UCFL 204-12	ASAHI	FU 0042-1	UCFL 207-23	NACHI	FU 0223-1	UCFL 211-34	FYH	FU 0365-1	UCFL 217-52	ASAHI	FU 0544-1
UCFL 204-12	FYH	FU 0042-1	UCFL 207-23 B	KOYO	FU 0223-1	UCFL 211-34	NACHI	FU 0365-1	UCFL 217-52	FYH	FU 0544-1
UCFL 204-12	NACHI	FU 0042-1	UCFL 207-24 B	KOYO	FU 0233-1	UCFL 211-35	SLB	FU 0384-1	UCFL 217-52	NACHI	FU 0544-1
UCFL 205	SLB	FU 0094-1	UCFL 207-25 B	KOYO	FU 0242-1	UCFL 211-35	ASAHI	FU 0384-1	UCFL 217-53	SLB	FU 0547-1
UCFL 205	ASAHI	FU 0094-1	UCFL 208	SLB	FU 0253-1	UCFL 211-35	FYH	FU 0384-1	UCFL 217-55	SLB	FU 0553-1
UCFL 205	FYH	FU 0094-1	UCFL 208	ASAHI	FU 0253-1	UCFL 211-35	NACHI	FU 0384-1	UCFL 218	SLB	FU 0559-1
UCFL 205	NACHI	FU 0094-1	UCFL 208	FYH	FU 0253-1	UCFL 212	SLB	FU 0410-1	UCFL 218	ASAHI	FU 0559-1
UCFL 205 B	KOYO	FU 0094-1	UCFL 208	NACHI	FU 0253-1	UCFL 212	ASAHI	FU 0410-1	UCFL 218	FYH	FU 0559-1
UCFL 205-13	SLB	FU 0060-1	UCFL 208 B	KOYO	FU 0253-1	UCFL 212	FYH	FU 0410-1	UCFL 218	NACHI	FU 0559-1
UCFL 205-13 B	KOYO	FU 0060-1	UCFL 208-24	SLB	FU 0233-1	UCFL 212	NACHI	FU 0410-1	UCFL 218-56	SLB	FU 0556-1
UCFL 205-14	SLB	FU 0071-1	UCFL 208-24	ASAHI	FU 0233-1	UCFL 212-36	SLB	FU 0392-1	UCFL 218-56	ASAHI	FU 0556-1
UCFL 205-14	ASAHI	FU 0071-1	UCFL 208-24	FYH	FU 0233-1	UCFL 212-36	ASAHI	FU 0392-1	UCFL 218-56	FYH	FU 0556-1
UCFL 205-14	FYH	FU 0071-1	UCFL 208-24	NACHI	FU 0233-1	UCFL 212-36	FYH	FU 0392-1	UCFL 218-56	NACHI	FU 0556-1
UCFL 205-14	NACHI	FU 0071-1	UCFL 208-25	SLB	FU 0242-1	UCFL 212-36	NACHI	FU 0392-1	UCFL 305	NSK	FU 0096-1
UCFL 205-14 B	KOYO	FU 0071-1	UCFL 208-25	ASAHI	FU 0242-1	UCFL 212-37	SLB	FU 0400-1	UCFL 305	ASAHI	FU 0096-1
UCFL 205-15	SLB	FU 0082-1	UCFL 208-25	FYH	FU 0242-1	UCFL 212-38	SLB	FU 0419-1	UCFL 305	FYH	FU 0096-1
UCFL 205-15	ASAHI	FU 0082-1	UCFL 208-25	NACHI	FU 0242-1	UCFL 212-38	ASAHI	FU 0419-1	UCFL 305-13	SLB	FU 0061-1
UCFL 205-15	FYH	FU 0082-1	UCFL 209	SLB	FU 0290-1	UCFL 212-38	FYH	FU 0419-1	UCFL 305-14	SLB	FU 0072-1
UCFL 205-15	NACHI	FU 0082-1	UCFL 209	ASAHI	FU 0290-1	UCFL 212-38	NACHI	FU 0419-1	UCFL 305-14 S	NSK	FU 0072-1
UCFL 205-15 B	KOYO	FU 0082-1	UCFL 209	FYH	FU 0290-1	UCFL 212-39	SLB	FU 0427-1	UCFL 305-15	SLB	FU 0083-1
UCFL 205-16	SLB	FU 0107-1	UCFL 209	NACHI	FU 0290-1	UCFL 212-39	ASAHI	FU 0427-1	UCFL 305-16	SLB	FU 0108-1
UCFL 205-16	ASAHI	FU 0107-1	UCFL 209 B	KOYO	FU 0290-1	UCFL 212-39	FYH	FU 0427-1	UCFL 305-16	ASAHI	FU 0108-1
UCFL 205-16	FYH	FU 0107-1	UCFL 209-26	SLB	FU 0261-1	UCFL 212-39	NACHI	FU 0427-1	UCFL 306	NSK	FU 0146-1
UCFL 205-16	NACHI	FU 0107-1	UCFL 209-26	ASAHI	FU 0261-1	UCFL 213	SLB	FU 0443-1	UCFL 306	SLB	FU 0146-1
UCFL 205-16 B	KOYO	FU 0107-1	UCFL 209-26	FYH	FU 0261-1	UCFL 213	ASAHI	FU 0443-1	UCFL 306	ASAHI	FU 0146-1
UCFL 206	SLB	FU 0143-1	UCFL 209-26	NACHI	FU 0261-1	UCFL 213	FYH	FU 0443-1	UCFL 306-17	SLB	FU 0121-1
UCFL 206	ASAHI	FU 0143-1	UCFL 209-26 B	KOYO	FU 0261-1	UCFL 213	NACHI	FU 0443-1	UCFL 306-18	SLB	FU 0132-1
UCFL 206	FYH	FU 0143-1	UCFL 209-27	SLB	FU 0270-1	UCFL 213-40	SLB	FU 0435-1	UCFL 306-18	ASAHI	FU 0132-1
UCFL 206	NACHI	FU 0143-1	UCFL 209-27	ASAHI	FU 0270-1	UCFL 213-40	ASAHI	FU 0435-1	UCFL 306-18 S	NSK	FU 0132-1
UCFL 206 B	KOYO	FU 0143-1	UCFL 209-27	FYH	FU 0270-1	UCFL 213-40	FYH	FU 0435-1	UCFL 306-19	SLB	FU 0157-1
UCFL 206-17	SLB	FU 0119-1	UCFL 209-27	NACHI	FU 0270-1	UCFL 213-40	NACHI	FU 0435-1	UCFL 306-20	SLB	FU 0176-1
UCFL 206-17	ASAHI	FU 0119-1	UCFL 209-27 B	KOYO	FU 0270-1	UCFL 213-41	SLB	FU 0451-1	UCFL 306-20	FYH	FU 0176-1
UCFL 206-17	NACHI	FU 0119-1	UCFL 209-28	SLB	FU 0279-1	UCFL 214	SLB	FU 0483-1	UCFL 307	NSK	FU 0212-1
UCFL 206-18	SLB	FU 0130-1	UCFL 209-28	ASAHI	FU 0279-1	UCFL 214	ASAHI	FU 0483-1	UCFL 307	SLB	FU 0212-1
UCFL 206-18	ASAHI	FU 0130-1	UCFL 209-28	FYH	FU 0279-1	UCFL 214	FYH	FU 0483-1	UCFL 307	ASAHI	FU 0212-1
UCFL 206-18	FYH	FU 0130-1	UCFL 209-28	NACHI	FU 0279-1	UCFL 214-42	SLB	FU 0459-1	UCFL 307	FYH	FU 0212-1
UCFL 206-18	NACHI	FU 0130-1	UCFL 209-28 B	KOYO	FU 0279-1	UCFL 214-43	SLB	FU 0467-1	UCFL 307-20	SLB	FU 0177-1
UCFL 206-18 B	KOYO	FU 0130-1	UCFL 210	SLB	FU 0330-1	UCFL 214-44	SLB	FU 0475-1	UCFL 307-20	ASAHI	FU 0177-1
UCFL 206-19	SLB	FU 0155-1	UCFL 210	KOYO	FU 0330-1	UCFL 214-44	ASAHI	FU 0475-1	UCFL 307-20	FYH	FU 0177-1
UCFL 206-19	ASAHI	FU 0155-1	UCFL 210	ASAHI	FU 0330-1	UCFL 214-44	FYH	FU 0475-1	UCFL 307-20 S	NSK	FU 0177-1
UCFL 206-19	FYH	FU 0155-1	UCFL 210	FYH	FU 0330-1	UCFL 215	SLB	FU 0511-1	UCFL 307-21	SLB	FU 0188-1
UCFL 206-19	NACHI	FU 0155-1	UCFL 210	NACHI	FU 0330-1	UCFL 215	ASAHI	FU 0511-1	UCFL 307-22	SLB	FU 0199-1
UCFL 206-19 B	KOYO	FU 0155-1	UCFL 210-29	SLB	FU 0301-1	UCFL 215	FYH	FU 0511-1			
UCFL 206-20	SLB	FU 0172-1	UCFL 210-30	SLB	FU 0310-1	UCFL 215-45	SLB	FU 0490-1			
UCFL 207	SLB	FU 0211-1	UCFL 210-30	KOYO	FU 0310-1	UCFL 215-46	SLB	FU 0497-1			
UCFL 207	ASAHI	FU 0211-1	UCFL 210-30	ASAHI	FU 0310-1						
UCFL 207	FYH	FU 0211-1	UCFL 210-30	FYH	FU 0310-1						
UCFL 207	NACHI	FU 0211-1	UCFL 210-30	NACHI	FU 0310-1						

BY PART NUMBER

BY PART NUMBER

Part No.	Brand	Group No.	Part No.	Brand	Group No.	Part No.	Brand	Group No.	Part No.	Brand	Group No.
UCFL 307-22	ASAHI	FU 0199-1	UCFL 313-40	FYH	FU 0436-1	UCFL X07-23	SLB	FU 0225-1	UCFL210-113D1	NTN	FU 0301-1
UCFL 307-22	FYH	FU 0199-1	UCFL 313-40 S	NSK	FU 0436-1	UCFL X07-23	ASAHI	FU 0225-1	UCFL210-114D1	NTN	FU 0310-1
UCFL 307-23	SLB	FU 0224-1	UCFL 313-41	SLB	FU 0452-1	UCFL X07-23	FYH	FU 0225-1	UCFL210-115D1	NTN	FU 0319-1
UCFL 308	NSK	FU 0256-1	UCFL 314	NSK	FU 0484-1	UCFL X08	SLB	FU 0255-1	UCFL210-200D1	NTN	FU 0344-1
UCFL 308	SLB	FU 0256-1	UCFL 314	SLB	FU 0484-1	UCFL X08	ASAHI	FU 0255-1	UCFL210D1	NTN	FU 0330-1
UCFL 308	ASAHI	FU 0256-1	UCFL 314	ASAHI	FU 0484-1	UCFL X08	FYH	FU 0255-1	UCFL211-200D1	NTN	FU 0346-1
UCFL 308	FYH	FU 0256-1	UCFL 314	FYH	FU 0484-1	UCFL X08	NSK	FU 0255-1	UCFL211-201D1	NTN	FU 0357-1
UCFL 308-24	SLB	FU 0235-1	UCFL 314-42	SLB	FU 0460-1	UCFL X08-24	SLB	FU 0234-1	UCFL211-202D1	NTN	FU 0365-1
UCFL 308-24	ASAHI	FU 0235-1	UCFL 314-43	SLB	FU 0468-1	UCFL X08-24	ASAHI	FU 0234-1	UCFL211-203D1	NTN	FU 0384-1
UCFL 308-24	FYH	FU 0235-1	UCFL 314-44	SLB	FU 0476-1	UCFL X08-24	FYH	FU 0234-1	UCFL211D1	NTN	FU 0375-1
UCFL 308-24 S	NSK	FU 0235-1	UCFL 314-44	ASAHI	FU 0476-1	UCFL X08-25	SLB	FU 0243-1	UCFL212-204D1	NTN	FU 0392-1
UCFL 308-25	SLB	FU 0244-1	UCFL 314-44	FYH	FU 0476-1	UCFL X09	NSK	FU 0293-1	UCFL212-205D1	NTN	FU 0400-1
UCFL 309	NSK	FU 0294-1	UCFL 314-44 S	NSK	FU 0476-1	UCFL X09	SLB	FU 0293-1	UCFL212-206D1	NTN	FU 0419-1
UCFL 309	SLB	FU 0294-1	UCFL 315	NSK	FU 0512-1	UCFL X09	ASAHI	FU 0293-1	UCFL212-207D1	NTN	FU 0427-1
UCFL 309	ASAHI	FU 0294-1	UCFL 315	SLB	FU 0512-1	UCFL X09	FYH	FU 0293-1	UCFL212D1	NTN	FU 0410-1
UCFL 309	FYH	FU 0294-1	UCFL 315	ASAHI	FU 0512-1	UCFL X09-26	SLB	FU 0263-1	UCFL213-208D1	NTN	FU 0435-1
UCFL 309-26	SLB	FU 0264-1	UCFL 315	FYH	FU 0512-1	UCFL X09-26	ASAHI	FU 0263-1	UCFL213-209D1	NTN	FU 0451-1
UCFL 309-26	ASAHI	FU 0264-1	UCFL 315-45	SLB	FU 0491-1	UCFL X09-27	SLB	FU 0272-1	UCFL213D1	NTN	FU 0443-1
UCFL 309-26 S	NSK	FU 0264-1	UCFL 315-46	SLB	FU 0498-1	UCFL X09-27	ASAHI	FU 0272-1	UCFL214-210D1	NTN	FU 0459-1
UCFL 309-27	SLB	FU 0273-1	UCFL 315-47	SLB	FU 0505-1	UCFL X09-27	FYH	FU 0272-1	UCFL214-211D1	NTN	FU 0467-1
UCFL 309-28	SLB	FU 0282-1	UCFL 315-48	SLB	FU 0519-1	UCFL X09-28	SLB	FU 0281-1	UCFL214-212D1	NTN	FU 0475-1
UCFL 309-28	ASAHI	FU 0282-1	UCFL 315-48	ASAHI	FU 0519-1	UCFL X09-28	ASAHI	FU 0281-1	UCFL214D1	NTN	FU 0483-1
UCFL 309-28	FYH	FU 0282-1	UCFL 315-48	FYH	FU 0519-1	UCFL X09-28	FYH	FU 0281-1	UCFL215-213D1	NTN	FU 0490-1
UCFL 309-28 S	NSK	FU 0282-1	UCFL 315-48 S	NSK	FU 0519-1	UCFL X10	NSK	FU 0332-1	UCFL215-214D1	NTN	FU 0497-1
UCFL 310	NSK	FU 0333-1	UCFL 316	NSK	FU 0538-1	UCFL X10	SLB	FU 0332-1	UCFL215-215D1	NTN	FU 0504-1
UCFL 310	SLB	FU 0333-1	UCFL 316	SLB	FU 0538-1	UCFL X10	ASAHI	FU 0332-1	UCFL215-300D1	NTN	FU 0518-1
UCFL 310	ASAHI	FU 0333-1	UCFL 316	ASAHI	FU 0538-1	UCFL X10	FYH	FU 0332-1	UCFL215D1	NTN	FU 0511-1
UCFL 310-31	FYH	FU 0333-1	UCFL 316	FYH	FU 0538-1	UCFL X10-29	SLB	FU 0302-1	UCFL216-301D1	NTN	FU 0525-1
UCFL 310-29	SLB	FU 0303-1	UCFL 316-49	SLB	FU 0526-1	UCFL X10-30	SLB	FU 0311-1	UCFL216-302D1	NTN	FU 0531-1
UCFL 310-30	SLB	FU 0312-1	UCFL 316-50	SLB	FU 0532-1	UCFL X10-30	ASAHI	FU 0311-1	UCFL216-303D1	NTN	FU 0541-1
UCFL 310-30	ASAHI	FU 0312-1	UCFL 316-50	ASAHI	FU 0532-1	UCFL X10-31	SLB	FU 0320-1	UCFL216D1	NTN	FU 0537-1
UCFL 310-30 S	NSK	FU 0312-1	UCFL 316-50 S	NSK	FU 0532-1	UCFL X10-31	ASAHI	FU 0320-1	UCFL217-304D1	NTN	FU 0544-1
UCFL 310-31	FYH	FU 0321-1	UCFL X05	SLB	FU 0098-1	UCFL X10-31	FYH	FU 0320-1	UCFL217-305D1	NTN	FU 0547-1
UCFL 310-31	SLB	FU 0321-1	UCFL X05	ASAHI	FU 0098-1	UCFL X10-32	SLB	FU 0347-1	UCFL217-307D1	NTN	FU 0553-1
UCFL 310-32	SLB	FU 0348-1	UCFL X05	FYH	FU 0098-1	UCFL X10-32	ASAHI	FU 0347-1	UCFL217D1	NTN	FU 0550-1
UCFL 310-32	FYH	FU 0348-1	UCFL X05	NSK	FU 0098-1	UCFL X10-32	FYH	FU 0347-1	UCFL218-308D1	NTN	FU 0556-1
UCFL 311	NSK	FU 0376-1	UCFL X05-13	SLB	FU 0062-1	UCFL201-008D1	NTN	FU 0010-1	UCFL218D1	NTN	FU 0559-1
UCFL 311	SLB	FU 0376-1	UCFL X05-14	SLB	FU 0073-1	UCFL201D1	NTN	FU 0005-1	UCFL305-013D1	NTN	FU 0061-1
UCFL 311	ASAHI	FU 0376-1	UCFL X05-14	ASAHI	FU 0073-1	UCFL202-009D1	NTN	FU 0015-1	UCFL305-014D1	NTN	FU 0072-1
UCFL 311	FYH	FU 0376-1	UCFL X05-15	SLB	FU 0084-1	UCFL202-010D1	NTN	FU 0025-1	UCFL305-015D1	NTN	FU 0083-1
UCFL 311-32	SLB	FU 0349-1	UCFL X05-15	ASAHI	FU 0084-1	UCFL202D1	NTN	FU 0020-1	UCFL305-100D1	NTN	FU 0108-1
UCFL 311-32	ASAHI	FU 0349-1	UCFL X05-16	SLB	FU 0109-1	UCFL203-011D1	NTN	FU 0035-1	UCFL305D1	NTN	FU 0096-1
UCFL 311-32	FYH	FU 0349-1	UCFL X05-16	ASAHI	FU 0109-1	UCFL203D1	NTN	FU 0030-1	UCFL306-101D1	NTN	FU 0121-1
UCFL 311-32 S	NSK	FU 0349-1	UCFL X05-16	FYH	FU 0109-1	UCFL204-012D1	NTN	FU 0042-1	UCFL306-102D1	NTN	FU 0132-1
UCFL 311-33	SLB	FU 0358-1	UCFL X06	SLB	FU 0145-1	UCFL204D1	NTN	FU 0050-1	UCFL306-103D1	NTN	FU 0157-1
UCFL 311-34	SLB	FU 0366-1	UCFL X06	ASAHI	FU 0145-1	UCFL205-013D1	NTN	FU 0060-1	UCFL306D1	NTN	FU 0146-1
UCFL 311-34	ASAHI	FU 0366-1	UCFL X06	FYH	FU 0145-1	UCFL205-014D1	NTN	FU 0071-1	UCFL307-104D1	NTN	FU 0177-1
UCFL 311-34 S	NSK	FU 0366-1	UCFL X06	NSK	FU 0145-1	UCFL205-015D1	NTN	FU 0082-1	UCFL307-105D1	NTN	FU 0188-1
UCFL 311-35	SLB	FU 0385-1	UCFL X06-17	SLB	FU 0120-1	UCFL205-100D1	NTN	FU 0107-1	UCFL307-106D1	NTN	FU 0199-1
UCFL 312	NSK	FU 0412-1	UCFL X06-18	SLB	FU 0131-1	UCFL205D1	NTN	FU 0094-1	UCFL307-107D1	NTN	FU 0224-1
UCFL 312	SLB	FU 0412-1	UCFL X06-18	ASAHI	FU 0131-1	UCFL206-101D1	NTN	FU 0119-1	UCFL307D1	NTN	FU 0212-1
UCFL 312	ASAHI	FU 0412-1	UCFL X06-19	SLB	FU 0156-1	UCFL206-102D1	NTN	FU 0130-1	UCFL308-108D1	NTN	FU 0235-1
UCFL 312	FYH	FU 0412-1	UCFL X06-19	ASAHI	FU 0156-1	UCFL206-103D1	NTN	FU 0155-1	UCFL308-109D1	NTN	FU 0244-1
UCFL 312-36	SLB	FU 0393-1	UCFL X06-19	FYH	FU 0156-1	UCFL206-104D1	NTN	FU 0172-1	UCFL308D1	NTN	FU 0256-1
UCFL 312-36	ASAHI	FU 0393-1	UCFL X06-20	SLB	FU 0175-1	UCFL206D1	NTN	FU 0143-1	UCFL309-110D1	NTN	FU 0264-1
UCFL 312-36 S	NSK	FU 0393-1	UCFL X06-20	ASAHI	FU 0175-1	UCFL207-104D1	NTN	FU 0174-1	UCFL309-111D1	NTN	FU 0273-1
UCFL 312-37	SLB	FU 0401-1	UCFL X06-20	FYH	FU 0175-1	UCFL207-105D1	NTN	FU 0187-1	UCFL309-112D1	NTN	FU 0282-1
UCFL 312-38	SLB	FU 0420-1	UCFL X07	SLB	FU 0214-1	UCFL207-106D1	NTN	FU 0198-1	UCFL309D1	NTN	FU 0294-1
UCFL 312-38	ASAHI	FU 0420-1	UCFL X07	ASAHI	FU 0214-1	UCFL207-107D1	NTN	FU 0223-1	UCFL310-113D1	NTN	FU 0303-1
UCFL 312-38 S	NSK	FU 0420-1	UCFL X07	FYH	FU 0214-1	UCFL207D1	NTN	FU 0211-1	UCFL310-114D1	NTN	FU 0312-1
UCFL 312-39	SLB	FU 0428-1	UCFL X07	NSK	FU 0214-1	UCFL208-108D1	NTN	FU 0233-1	UCFL310-115D1	NTN	FU 0321-1
UCFL 313	NSK	FU 0444-1	UCFL X07-20	SLB	FU 0178-1	UCFL208-109D1	NTN	FU 0242-1	UCFL310D1	NTN	FU 0333-1
UCFL 313	SLB	FU 0444-1	UCFL X07-20	FYH	FU 0178-1	UCFL208D1	NTN	FU 0253-1	UCFL311-200D1	NTN	FU 0349-1
UCFL 313	ASAHI	FU 0444-1	UCFL X07-21	SLB	FU 0189-1	UCFL209-110D1	NTN	FU 0261-1	UCFL311-201D1	NTN	FU 0358-1
UCFL 313	FYH	FU 0444-1	UCFL X07-22	SLB	FU 0200-1	UCFL209-111D1	NTN	FU 0270-1	UCFL311-202D1	NTN	FU 0366-1
UCFL 313-40	SLB	FU 0436-1	UCFL X07-22	ASAHI	FU 0200-1	UCFL209-112D1	NTN	FU 0279-1	UCFL311-203D1	NTN	FU 0385-1
UCFL 313-40	ASAHI	FU 0436-1	UCFL X07-22	FYH	FU 0200-1	UCFL209D1	NTN	FU 0290-1	UCFL311D1	NTN	FU 0376-1

BY PART NUMBER

Part No.	Brand	Group No.	Part No.	Brand	Group No.	Part No.	Brand	Group No.	Part No.	Brand	Group No.
UCFL312-204D1	NTN	FU 0393-1	UCFS 209	SLB	FU 0295-1	UCFT 207-23	SLB	FU 0222-1	UCFX07-107D1	NTN	FU 0220-1
UCFL312-205D1	NTN	FU 0401-1	UCFS 209-26	SLB	FU 0265-1	UCFT 207-23	ASAHI	FU 0222-1	UCFX07D1	NTN	FU 0206-1
UCFL312-206D1	NTN	FU 0420-1	UCFS 209-27	SLB	FU 0274-1	UCFT 208	SLB	FU 0252-1	UCFX08-108D1	NTN	FU 0229-1
UCFL312-207D1	NTN	FU 0428-1	UCFS 209-28	SLB	FU 0283-1	UCFT 208	ASAHI	FU 0252-1	UCFX08-109D1	NTN	FU 0238-1
UCFL312D1	NTN	FU 0412-1	UCFS 210	SLB	FU 0334-1	UCFT 208-24	SLB	FU 0232-1	UCFX08D1	NTN	FU 0248-1
UCFL313-208D1	NTN	FU 0436-1	UCFS 210-29	SLB	FU 0304-1	UCFT 208-24	ASAHI	FU 0232-1	UCFX09-110D1	NTN	FU 0258-1
UCFL313-209D1	NTN	FU 0452-1	UCFS 210-29	FYH	FU 0304-1	UCFT 208-25	SLB	FU 0241-1	UCFX09-111D1	NTN	FU 0267-1
UCFL313D1	NTN	FU 0444-1	UCFS 210-30	SLB	FU 0313-1	UCFT 208-25	ASAHI	FU 0241-1	UCFX09-112D1	NTN	FU 0276-1
UCFL314-210D1	NTN	FU 0460-1	UCFS 210-31	SLB	FU 0322-1	UCFT 209	SLB	FU 0291-1	UCFX09D1	NTN	FU 0286-1
UCFL314-211D1	NTN	FU 0468-1	UCFS 210-32	SLB	FU 0350-1	UCFT 209	ASAHI	FU 0291-1	UCFX10-113D1	NTN	FU 0297-1
UCFL314-212D1	NTN	FU 0476-1	UCFS 211	SLB	FU 0378-1	UCFT 209-26	SLB	FU 0262-1	UCFX10-114D1	NTN	FU 0306-1
UCFL314D1	NTN	FU 0484-1	UCFS 211-32	SLB	FU 0351-1	UCFT 209-26	ASAHI	FU 0262-1	UCFX10-115D1	NTN	FU 0315-1
UCFL315-213D1	NTN	FU 0491-1	UCFS 211-33	SLB	FU 0359-1	UCFT 209-27	SLB	FU 0271-1	UCFX10-200D1	NTN	FU 0337-1
UCFL315-214D1	NTN	FU 0498-1	UCFS 211-34	SLB	FU 0367-1	UCFT 209-27	ASAHI	FU 0271-1	UCFX10D1	NTN	FU 0325-1
UCFL315-215D1	NTN	FU 0505-1	UCFS 211-35	SLB	FU 0386-1	UCFT 209-28	SLB	FU 0280-1	UCFX11-201D1	NTN	FU 0354-1
UCFL315-300D1	NTN	FU 0519-1	UCFS 212	SLB	FU 0413-1	UCFT 209-28	ASAHI	FU 0280-1	UCFX11-202D1	NTN	FU 0362-1
UCFL315D1	NTN	FU 0512-1	UCFS 212-36	SLB	FU 0394-1	UCFT 210	SLB	FU 0329-1	UCFX11-203D1	NTN	FU 0381-1
UCFL316-301D1	NTN	FU 0526-1	UCFS 212-37	FYH	FU 0402-1	UCFT 210	ASAHI	FU 0329-1	UCFX11D1	NTN	FU 0371-1
UCFL316-302D1	NTN	FU 0532-1	UCFS 212-37	SLB	FU 0402-1	UCFT 210-29	SLB	FU 0300-1	UCFX12-206D1	NTN	FU 0415-1
UCFL316D1	NTN	FU 0538-1	UCFS 212-38	SLB	FU 0421-1	UCFT 210-29	FYH	FU 0300-1	UCFX12-207D1	NTN	FU 0423-1
UCFLX05-013D1	NTN	FU 0062-1	UCFS 212-39	SLB	FU 0429-1	UCFT 210-30	SLB	FU 0309-1	UCFX12D1	NTN	FU 0405-1
UCFLX05-014D1	NTN	FU 0073-1	UCFS 213	SLB	FU 0445-1	UCFT 210-30	ASAHI	FU 0309-1	UCFX13-208D1	NTN	FU 0431-1
UCFLX05-015D1	NTN	FU 0084-1	UCFS 213-40	SLB	FU 0437-1	UCFT 210-31	SLB	FU 0318-1	UCFX13-209D1	NTN	FU 0447-1
UCFLX05-100D1	NTN	FU 0109-1	UCFS 213-41	SLB	FU 0453-1	UCFT 210-31	ASAHI	FU 0318-1	UCFX13D1	NTN	FU 0439-1
UCFLX05D1	NTN	FU 0098-1	UCFS 213-41	FYH	FU 0453-1	UCFT 210-32	SLB	FU 0343-1	UCFX14-210D1	NTN	FU 0455-1
UCFLX06-101D1	NTN	FU 0120-1	UCFS 214	SLB	FU 0485-1	UCFT 211	SLB	FU 0374-1	UCFX14-211D1	NTN	FU 0463-1
UCFLX06-102D1	NTN	FU 0131-1	UCFS 214-42	SLB	FU 0461-1	UCFT 211	ASAHI	FU 0374-1	UCFX14-212D1	NTN	FU 0471-1
UCFLX06-103D1	NTN	FU 0156-1	UCFS 214-42	FYH	FU 0461-1	UCFT 211-32	SLB	FU 0345-1	UCFX14D1	NTN	FU 0479-1
UCFLX06-104D1	NTN	FU 0175-1	UCFS 214-43	SLB	FU 0469-1	UCFT 211-32	ASAHI	FU 0345-1	UCFX15-213D1	NTN	FU 0486-1
UCFLX06D1	NTN	FU 0145-1	UCFS 214-44	SLB	FU 0477-1	UCFT 211-33	SLB	FU 0356-1	UCFX15-214D1	NTN	FU 0493-1
UCFLX07-105D1	NTN	FU 0189-1	UCFS 215	SLB	FU 0513-1	UCFT 211-33	ASAHI	FU 0356-1	UCFX15-215D1	NTN	FU 0500-1
UCFLX07-106D1	NTN	FU 0200-1	UCFS 215-45	SLB	FU 0492-1	UCFT 211-34	SLB	FU 0364-1	UCFX15-300D1	NTN	FU 0514-1
UCFLX07-107D1	NTN	FU 0225-1	UCFS 215-45	FYH	FU 0492-1	UCFT 211-34	ASAHI	FU 0364-1	UCFX15D1	NTN	FU 0507-1
UCFLX07D1	NTN	FU 0214-1	UCFS 215-46	SLB	FU 0499-1	UCFT 211-35	SLB	FU 0383-1	UCFX16-301D1	NTN	FU 0522-1
UCFLX08-108D1	NTN	FU 0234-1	UCFS 215-47	SLB	FU 0506-1	UCFT 211-35	ASAHI	FU 0383-1	UCFX16-302D1	NTN	FU 0528-1
UCFLX08-109D1	NTN	FU 0243-1	UCFS 215-48	SLB	FU 0520-1	UCFT 212	SLB	FU 0409-1	UCFX16D1	NTN	FU 0534-1
UCFLX08D1	NTN	FU 0255-1	UCFT 204	SLB	FU 0049-1	UCFT 212-36	SLB	FU 0391-1	UCLF 204	ASAHI	FU 0043-1
UCFLX09-110D1	NTN	FU 0263-1	UCFT 204	ASAHI	FU 0049-1	UCFT 212-37	SLB	FU 0399-1	UCLF 204-12	ASAHI	FU 0036-1
UCFLX09-111D1	NTN	FU 0272-1	UCFT 204-12	SLB	FU 0041-1	UCFT 212-37	FYH	FU 0399-1	UCLF 205	ASAHI	FU 0099-1
UCFLX09-112D1	NTN	FU 0281-1	UCFT 204-12	ASAHI	FU 0041-1	UCFT 212-38	SLB	FU 0418-1	UCLF 205-14	ASAHI	FU 0074-1
UCFLX09D1	NTN	FU 0293-1	UCFT 205	SLB	FU 0093-1	UCFT 212-39	SLB	FU 0426-1	UCLF 205-15	ASAHI	FU 0085-1
UCFLX10-113D1	NTN	FU 0302-1	UCFT 205	ASAHI	FU 0093-1	UCFT 213	SLB	FU 0442-1	UCLF 205-16	ASAHI	FU 0110-1
UCFLX10-114D1	NTN	FU 0311-1	UCFT 205-13	SLB	FU 0059-1	UCFT 213	FYH	FU 0442-1	UCLF 206	ASAHI	FU 0133-1
UCFLX10-115D1	NTN	FU 0320-1	UCFT 205-13	FYH	FU 0059-1	UCFT 213-40	SLB	FU 0434-1	UCLF 206-17	ASAHI	FU 0111-1
UCFLX10-200D1	NTN	FU 0347-1	UCFT 205-14	SLB	FU 0070-1	UCFT 213-40	FYH	FU 0434-1	UCLF 206-18	ASAHI	FU 0122-1
UCFLX10D1	NTN	FU 0332-1	UCFT 205-14	ASAHI	FU 0070-1	UCFT 213-41	SLB	FU 0450-1	UCLF 206-19	ASAHI	FU 0147-1
UCFS 204	SLB	FU 0043-1	UCFT 205-15	SLB	FU 0081-1	UCFT 213-41	FYH	FU 0450-1	UCLF 207	ASAHI	FU 0215-1
UCFS 204-12	SLB	FU 0036-1	UCFT 205-15	ASAHI	FU 0081-1	UCFT 214	SLB	FU 0482-1	UCLF 207-20	ASAHI	FU 0179-1
UCFS 205	SLB	FU 0099-1	UCFT 205-16	SLB	FU 0106-1	UCFT 214	FYH	FU 0482-1	UCLF 207-21	ASAHI	FU 0190-1
UCFS 205-13	SLB	FU 0063-1	UCFT 205-16	ASAHI	FU 0106-1	UCFT 214-42	SLB	FU 0458-1	UCLF 207-22	ASAHI	FU 0201-1
UCFS 205-13	FYH	FU 0063-1	UCFT 206	SLB	FU 0142-1	UCFT 214-42	FYH	FU 0458-1	UCLF 207-23	ASAHI	FU 0226-1
UCFS 205-14	SLB	FU 0074-1	UCFT 206	ASAHI	FU 0142-1	UCFT 214-43	SLB	FU 0466-1	UCLF 208	ASAHI	FU 0245-1
UCFS 205-15	SLB	FU 0085-1	UCFT 206-17	SLB	FU 0118-1	UCFT 214-43	FYH	FU 0466-1	UCLF 208-24	ASAHI	FU 0227-1
UCFS 205-16	SLB	FU 0110-1	UCFT 206-17	ASAHI	FU 0118-1	UCFT 214-44	SLB	FU 0474-1	UCLF 208-25	ASAHI	FU 0236-1
UCFS 206	SLB	FU 0133-1	UCFT 206-18	SLB	FU 0129-1	UCFT 214-44	FYH	FU 0474-1	UCLF 209	ASAHI	FU 0295-1
UCFS 206-17	SLB	FU 0111-1	UCFT 206-18	ASAHI	FU 0129-1	UCFX05-013D1	NTN	FU 0057-1	UCLF 209-26	ASAHI	FU 0265-1
UCFS 206-18	SLB	FU 0122-1	UCFT 206-19	SLB	FU 0154-1	UCFX05-014D1	NTN	FU 0068-1	UCLF 209-27	ASAHI	FU 0274-1
UCFS 206-19	SLB	FU 0147-1	UCFT 206-19	ASAHI	FU 0154-1	UCFX05-015D1	NTN	FU 0079-1	UCLF 209-28	ASAHI	FU 0283-1
UCFS 206-20	SLB	FU 0158-1	UCFT 206-20	SLB	FU 0171-1	UCFX05-100D1	NTN	FU 0104-1	UCLF 210	ASAHI	FU 0334-1
UCFS 207	SLB	FU 0215-1	UCFT 207	SLB	FU 0210-1	UCFX05D1	NTN	FU 0090-1	UCLF 210-30	ASAHI	FU 0313-1
UCFS 207-20	SLB	FU 0179-1	UCFT 207	ASAHI	FU 0210-1	UCFX06-101D1	NTN	FU 0115-1	UCLF 210-31	ASAHI	FU 0322-1
UCFS 207-21	SLB	FU 0190-1	UCFT 207-20	SLB	FU 0173-1	UCFX06-102D1	NTN	FU 0126-1	UCLF 211	ASAHI	FU 0378-1
UCFS 207-22	SLB	FU 0201-1	UCFT 207-20	ASAHI	FU 0173-1	UCFX06-103D1	NTN	FU 0151-1	UCLF 211-32	ASAHI	FU 0351-1
UCFS 207-23	SLB	FU 0226-1	UCFT 207-21	SLB	FU 0186-1	UCFX06-104D1	NTN	FU 0163-1	UCLF 211-33	ASAHI	FU 0359-1
UCFS 208	SLB	FU 0245-1	UCFT 207-21	ASAHI	FU 0186-1	UCFX06D1	NTN	FU 0138-1	UCLF 211-34	ASAHI	FU 0367-1
UCFS 208-24	SLB	FU 0227-1	UCFT 207-22	SLB	FU 0197-1	UCFX07-105D1	NTN	FU 0184-1	UCLF 211-35	ASAHI	FU 0386-1
UCFS 208-25	SLB	FU 0236-1	UCFT 207-22	ASAHI	FU 0197-1	UCFX07-106D1	NTN	FU 0195-1	UCLF 212	ASAHI	FU 0413-1

BY PART NUMBER

Part No.	Brand	Group No.	Part No.	Brand	Group No.	Part No.	Brand	Group No.	Part No.	Brand	Group No.
UCLF 212-36	ASAHI	FU 0394-1	UELF206-104D1W3	NTN	FU 0159-2	UELFC 210	SLB	FU 0327-2	UELFC213-209D1W3	NTN	FU 0449-2
UCLF 212-38	ASAHI	FU 0421-1	UELF206D1W3	NTN	FU 0134-2	UELFC 210-29	SLB	FU 0299-2	UELFC213D1W3	NTN	FU 0441-2
UCLF 212-39	ASAHI	FU 0429-1	UELF207-104D1W3	NTN	FU 0162-2	UELFC 210-30	SLB	FU 0308-2	UELFC214-210D1W3	NTN	FU 0456-2
UELF 202	SLB	FU 0018-2	UELF207-105D1W3	NTN	FU 0180-2	UELFC 210-31	SLB	FU 0317-2	UELFC214-211D1W3	NTN	FU 0464-2
UELF 202-10	SLB	FU 0023-2	UELF207-106D1W3	NTN	FU 0191-2	UELFC 210-32	SLB	FU 0339-2	UELFC214-212D1W3	NTN	FU 0472-2
UELF 203	SLB	FU 0028-2	UELF207-107D1W3	NTN	FU 0216-2	UELFC 211	SLB	FU 0372-2	UELFC214D1W3	NTN	FU 0480-2
UELF 204	SLB	FU 0044-2	UELF207D1W3	NTN	FU 0202-2	UELFC 211-32	SLB	FU 0342-2	UELFC215-213D1W3	NTN	FU 0488-2
UELF 204-12	SLB	FU 0037-2	UELF208-108D1W3	NTN	FU 0228-2	UELFC 211-33	SLB	FU 0355-2	UELFC215-214D1W3	NTN	FU 0495-2
UELF 205	SLB	FU 0086-2	UELF208-109D1W3	NTN	FU 0237-2	UELFC 211-34	SLB	FU 0363-2	UELFC215-215D1W3	NTN	FU 0502-2
UELF 205-13	SLB	FU 0053-2	UELF208D1W3	NTN	FU 0246-2	UELFC 211-35	SLB	FU 0382-2	UELFC215-300D1W3	NTN	FU 0516-2
UELF 205-14	SLB	FU 0064-2	UELF209-110D1W3	NTN	FU 0257-2	UELFC 212	SLB	FU 0407-2	UELFC215D1W3	NTN	FU 0509-2
UELF 205-15	SLB	FU 0075-2	UELF209-111D1W3	NTN	FU 0266-2	UELFC 212-36	SLB	FU 0390-2	UELFL 202	SLB	FU 0020-2
UELF 205-16	SLB	FU 0100-2	UELF209-112D1W3	NTN	FU 0275-2	UELFC 212-37	SLB	FU 0398-2	UELFL 202-10	SLB	FU 0025-2
UELF 206	SLB	FU 0134-2	UELF209D1W3	NTN	FU 0284-2	UELFC 212-38	SLB	FU 0417-2	UELFL 203	SLB	FU 0030-2
UELF 206-17	SLB	FU 0112-2	UELF210-113D1W3	NTN	FU 0296-2	UELFC 212-39	SLB	FU 0425-2	UELFL 204	SLB	FU 0050-2
UELF 206-18	SLB	FU 0123-2	UELF210-114D1W3	NTN	FU 0305-2	UELFC 213	SLB	FU 0441-2	UELFL 204-12	SLB	FU 0042-2
UELF 206-19	SLB	FU 0148-2	UELF210-115D1W3	NTN	FU 0314-2	UELFC 213-40	SLB	FU 0433-2	UELFL 205	SLB	FU 0094-2
UELF 206-20	SLB	FU 0159-2	UELF210-200D1W3	NTN	FU 0335-2	UELFC 213-41	SLB	FU 0449-2	UELFL 205-13	SLB	FU 0060-2
UELF 207	SLB	FU 0202-2	UELF210D1W3	NTN	FU 0323-2	UELFC 214	SLB	FU 0480-2	UELFL 205-14	SLB	FU 0071-2
UELF 207-20	SLB	FU 0162-2	UELF211-200D1W3	NTN	FU 0336-2	UELFC 214-42	SLB	FU 0456-2	UELFL 205-15	SLB	FU 0082-2
UELF 207-21	SLB	FU 0180-2	UELF211-201D1W3	NTN	FU 0352-2	UELFC 214-43	SLB	FU 0464-2	UELFL 205-16	SLB	FU 0107-2
UELF 207-22	SLB	FU 0191-2	UELF211-202D1W3	NTN	FU 0360-2	UELFC 214-44	SLB	FU 0472-2	UELFL 206	SLB	FU 0143-2
UELF 207-23	SLB	FU 0216-2	UELF211-203D1W3	NTN	FU 0379-2	UELFC 215	SLB	FU 0509-2	UELFL 206-17	SLB	FU 0119-2
UELF 208	SLB	FU 0246-2	UELF211D1W3	NTN	FU 0368-2	UELFC 215-45	SLB	FU 0488-2	UELFL 206-18	SLB	FU 0130-2
UELF 208-24	SLB	FU 0228-2	UELF212-204D1W3	NTN	FU 0387-2	UELFC 215-46	SLB	FU 0495-2	UELFL 206-19	SLB	FU 0155-2
UELF 208-25	SLB	FU 0237-2	UELF212-205D1W3	NTN	FU 0395-2	UELFC 215-47	SLB	FU 0502-2	UELFL 206-20	SLB	FU 0172-2
UELF 209	SLB	FU 0284-2	UELF212-206D1W3	NTN	FU 0414-2	UELFC 215-48	SLB	FU 0516-2	UELFL 207	SLB	FU 0211-2
UELF 209-26	SLB	FU 0257-2	UELF212-207D1W3	NTN	FU 0422-2	UELFC204-012D1W3	NTN	FU 0040-2	UELFL 207-20	SLB	FU 0174-2
UELF 209-27	SLB	FU 0266-2	UELF212D1W3	NTN	FU 0403-2	UELFC204D1W3	NTN	FU 0048-2	UELFL 207-21	SLB	FU 0187-2
UELF 209-28	SLB	FU 0275-2	UELF213-208D1W3	NTN	FU 0430-2	UELFC205-013D1W3	NTN	FU 0058-2	UELFL 207-22	SLB	FU 0198-2
UELF 210	SLB	FU 0323-2	UELF213-209D1W3	NTN	FU 0446-2	UELFC205-014D1W3	NTN	FU 0069-2	UELFL 207-23	SLB	FU 0223-2
UELF 210-29	SLB	FU 0296-2	UELF213D1W3	NTN	FU 0438-2	UELFC205-015D1W3	NTN	FU 0080-2	UELFL 208	SLB	FU 0253-2
UELF 210-30	SLB	FU 0305-2	UELF214-210D1W3	NTN	FU 0454-2	UELFC205-100D1W3	NTN	FU 0105-2	UELFL 208-24	SLB	FU 0233-2
UELF 210-31	SLB	FU 0314-2	UELF214-211D1W3	NTN	FU 0462-2	UELFC205D1W3	NTN	FU 0092-2	UELFL 208-25	SLB	FU 0242-2
UELF 210-32	SLB	FU 0335-2	UELF214-212D1W3	NTN	FU 0470-2	UELFC206-101D1W3	NTN	FU 0117-2	UELFL 209	SLB	FU 0290-2
UELF 211	SLB	FU 0368-2	UELF214D1W3	NTN	FU 0478-2	UELFC206-102D1W3	NTN	FU 0128-2	UELFL 209-26	SLB	FU 0261-2
UELF 211-32	SLB	FU 0336-2	UELF215-213D1W3	NTN	FU 0487-2	UELFC206-103D1W3	NTN	FU 0153-2	UELFL 209-27	SLB	FU 0270-2
UELF 211-33	SLB	FU 0352-2	UELF215-214D1W3	NTN	FU 0494-2	UELFC206-104D1W3	NTN	FU 0167-2	UELFL 209-28	SLB	FU 0279-2
UELF 211-34	SLB	FU 0360-2	UELF215-215D1W3	NTN	FU 0501-2	UELFC206D1W3	NTN	FU 0140-2	UELFL 210	SLB	FU 0330-2
UELF 211-35	SLB	FU 0379-2	UELF215-300D1W3	NTN	FU 0515-2	UELFC207-104D1W3	NTN	FU 0170-2	UELFL 210-29	SLB	FU 0301-2
UELF 212	SLB	FU 0403-2	UELF215D1W3	NTN	FU 0508-2	UELFC207-105D1W3	NTN	FU 0185-2	UELFL 210-30	SLB	FU 0310-2
UELF 212-36	SLB	FU 0387-2	UELFC 202	SLB	FU 0019-2	UELFC207-106D1W3	NTN	FU 0196-2	UELFL 210-31	SLB	FU 0319-2
UELF 212-37	SLB	FU 0395-2	UELFC 203	SLB	FU 0029-2	UELFC207-107D1W3	NTN	FU 0221-2	UELFL 210-32	SLB	FU 0344-2
UELF 212-38	SLB	FU 0414-2	UELFC 204	SLB	FU 0048-2	UELFC207D1W3	NTN	FU 0208-2	UELFL 211	SLB	FU 0375-2
UELF 212-39	SLB	FU 0422-2	UELFC 204-12	SLB	FU 0040-2	UELFC208-108D1W3	NTN	FU 0231-2	UELFL 211-32	SLB	FU 0346-2
UELF 213	SLB	FU 0438-2	UELFC 205	SLB	FU 0092-2	UELFC208-109D1W3	NTN	FU 0240-2	UELFL 211-33	SLB	FU 0357-2
UELF 213-40	SLB	FU 0430-2	UELFC 205-13	SLB	FU 0058-2	UELFC208D1W3	NTN	FU 0250-2	UELFL 211-34	SLB	FU 0365-2
UELF 213-41	SLB	FU 0446-2	UELFC 205-14	SLB	FU 0069-2	UELFC209-110D1W3	NTN	FU 0260-2	UELFL 211-35	SLB	FU 0384-2
UELF 214	SLB	FU 0478-2	UELFC 205-15	SLB	FU 0080-2	UELFC209-111D1W3	NTN	FU 0269-2	UELFL 212	SLB	FU 0410-2
UELF 214-42	SLB	FU 0454-2	UELFC 205-16	SLB	FU 0105-2	UELFC209-112D1W3	NTN	FU 0278-2	UELFL 212-36	SLB	FU 0392-2
UELF 214-43	SLB	FU 0462-2	UELFC 206	SLB	FU 0140-2	UELFC209D1W3	NTN	FU 0288-2	UELFL 212-37	SLB	FU 0400-2
UELF 214-44	SLB	FU 0470-2	UELFC 206-17	SLB	FU 0117-2	UELFC210-113D1W3	NTN	FU 0299-2	UELFL 212-38	SLB	FU 0419-2
UELF 215	SLB	FU 0508-2	UELFC 206-18	SLB	FU 0128-2	UELFC210-114D1W3	NTN	FU 0308-2	UELFL 212-39	SLB	FU 0427-2
UELF 215-45	SLB	FU 0487-2	UELFC 206-19	SLB	FU 0153-2	UELFC210-115D1W3	NTN	FU 0317-2	UELFL 213	SLB	FU 0443-2
UELF 215-46	SLB	FU 0494-2	UELFC 206-20	SLB	FU 0167-2	UELFC210-200D1W3	NTN	FU 0339-2	UELFL 213-40	SLB	FU 0435-2
UELF 215-47	SLB	FU 0501-2	UELFC 207	SLB	FU 0208-2	UELFC210D1W3	NTN	FU 0327-2	UELFL 213-41	SLB	FU 0451-2
UELF 215-48	SLB	FU 0515-2	UELFC 207-20	SLB	FU 0170-2	UELFC211-200D1W3	NTN	FU 0342-2	UELFL 214	SLB	FU 0483-2
UELF204-012D1W3	NTN	FU 0037-2	UELFC 207-21	SLB	FU 0185-2	UELFC211-201D1W3	NTN	FU 0355-2	UELFL 214-42	SLB	FU 0459-2
UELF204D1W3	NTN	FU 0044-2	UELFC 207-22	SLB	FU 0196-2	UELFC211-202D1W3	NTN	FU 0363-2	UELFL 214-43	SLB	FU 0467-2
UELF205-013D1W3	NTN	FU 0053-2	UELFC 207-23	SLB	FU 0221-2	UELFC211-203D1W3	NTN	FU 0382-2	UELFL 214-44	SLB	FU 0475-2
UELF205-014D1W3	NTN	FU 0064-2	UELFC 208	SLB	FU 0250-2	UELFC211D1W3	NTN	FU 0372-2	UELFL 215	SLB	FU 0511-2
UELF205-015D1W3	NTN	FU 0075-2	UELFC 208-24	SLB	FU 0231-2	UELFC212-204D1W3	NTN	FU 0390-2	UELFL 215-45	SLB	FU 0490-2
UELF205-100D1W3	NTN	FU 0100-2	UELFC 208-25	SLB	FU 0240-2	UELFC212-205D1W3	NTN	FU 0398-2	UELFL 215-46	SLB	FU 0497-2
UELF205D1W3	NTN	FU 0086-2	UELFC 209	SLB	FU 0288-2	UELFC212-206D1W3	NTN	FU 0417-2	UELFL 215-47	SLB	FU 0504-2
UELF206-101D1W3	NTN	FU 0112-2	UELFC 209-26	SLB	FU 0260-2	UELFC212-207D1W3	NTN	FU 0425-2	UELFL 215-48	SLB	FU 0518-2
UELF206-102D1W3	NTN	FU 0123-2	UELFC 209-27	SLB	FU 0269-2	UELFC212D1W3	NTN	FU 0407-2	UELFL204-012D1W3	NTN	FU 0042-2
UELF206-103D1W3	NTN	FU 0148-2	UELFC 209-28	SLB	FU 0278-2	UELFC213-208D1W3	NTN	FU 0433-2	UELFL204D1W3	NTN	FU 0050-2

BY PART NUMBER

Part No.	Brand	Group No.	Part No.	Brand	Group No.	Part No.	Brand	Group No.	Part No.	Brand	Group No.
UELFL205-013D1W3	NTN	·····FU 0060-2	UELFLU208-109D1W3	NTN	·····FU 0241-2	UELF213	SLB	·····FU 0445-2	UELFU206D1W3	NTN	·····FU 0133-2
UELFL205-014D1W3	NTN	·····FU 0071-2	UELFLU208D1W3	NTN	·····FU 0252-2	UELF213-40	SLB	·····FU 0437-2	UELFU207-104D1W3	NTN	·····FU 0179-2
UELFL205-015D1W3	NTN	·····FU 0082-2	UELFLU209-110D1W3	NTN	·····FU 0262-2	UELF213-41	SLB	·····FU 0453-2	UELFU207-105D1W3	NTN	·····FU 0190-2
UELFL205-100D1W3	NTN	·····FU 0107-2	UELFLU209-111D1W3	NTN	·····FU 0271-2	UELF214	SLB	·····FU 0485-2	UELFU207-106D1W3	NTN	·····FU 0201-2
UELFL205D1W3	NTN	·····FU 0094-2	UELFLU209-112D1W3	NTN	·····FU 0280-2	UELF214-42	SLB	·····FU 0461-2	UELFU207-107D1W3	NTN	·····FU 0226-2
UELFL206-101D1W3	NTN	·····FU 0119-2	UELFLU209D1W3	NTN	·····FU 0291-2	UELF214-43	SLB	·····FU 0469-2	UELFU207D1W3	NTN	·····FU 0215-2
UELFL206-102D1W3	NTN	·····FU 0130-2	UELFLU210-113D1W3	NTN	·····FU 0300-2	UELF214-44	SLB	·····FU 0477-2	UELFU208-108D1W3	NTN	·····FU 0227-2
UELFL206-103D1W3	NTN	·····FU 0155-2	UELFLU210-114D1W3	NTN	·····FU 0309-2	UELF215	SLB	·····FU 0513-2	UELFU208-109D1W3	NTN	·····FU 0236-2
UELFL206-104D1W3	NTN	·····FU 0172-2	UELFLU210-115D1W3	NTN	·····FU 0318-2	UELF215-46	SLB	·····FU 0499-2	UELFU208D1W3	NTN	·····FU 0245-2
UELFL206D1W3	NTN	·····FU 0143-2	UELFLU210-200D1W3	NTN	·····FU 0343-2	UELF215-47	SLB	·····FU 0506-2	UELFU209-110D1W3	NTN	·····FU 0265-2
UELFL207-104D1W3	NTN	·····FU 0174-2	UELFLU210D1W3	NTN	·····FU 0329-2	UELF215-47	SLB	·····FU 0506-2	UELFU209-111D1W3	NTN	·····FU 0274-2
UELFL207-105D1W3	NTN	·····FU 0187-2	UELFLU211-200D1W3	NTN	·····FU 0345-2	UELF215-47	SLB	·····FU 0506-2	UELFU209-112D1W3	NTN	·····FU 0283-2
UELFL207-106D1W3	NTN	·····FU 0198-2	UELFLU211-201D1W3	NTN	·····FU 0356-2	UELF215-47	SLB	·····FU 0506-2	UELFU209D1W3	NTN	·····FU 0295-2
UELFL207-107D1W3	NTN	·····FU 0223-2	UELFLU211-202D1W3	NTN	·····FU 0364-2	UELF215-46	SLB	·····FU 0499-2	UELFU210-113D1W3	NTN	·····FU 0304-2
UELFL207D1W3	NTN	·····FU 0211-2	UELFLU211-203D1W3	NTN	·····FU 0383-2	UELF215-47	SLB	·····FU 0506-2	UELFU210-114D1W3	NTN	·····FU 0313-2
UELFL208-108D1W3	NTN	·····FU 0233-2	UELFLU211D1W3	NTN	·····FU 0374-2	UELF215-47	SLB	·····FU 0506-2	UELFU210-115D1W3	NTN	·····FU 0322-2
UELFL208-109D1W3	NTN	·····FU 0242-2	UELFLU212-204D1W3	NTN	·····FU 0391-2	UELF215-47	SLB	·····FU 0506-2	UELFU210-200D1W3	NTN	·····FU 0350-2
UELFL208D1W3	NTN	·····FU 0253-2	UELFLU212-205D1W3	NTN	·····FU 0399-2	UELF215-47	SLB	·····FU 0506-2	UELFU210D1W3	NTN	·····FU 0334-2
UELFL209-110D1W3	NTN	·····FU 0261-2	UELFLU212-206D1W3	NTN	·····FU 0418-2	UELF215-47	SLB	·····FU 0506-2	UELFU211-200D1W3	NTN	·····FU 0351-2
UELFL209-111D1W3	NTN	·····FU 0270-2	UELFLU212-207D1W3	NTN	·····FU 0426-2	UELF215-47	SLB	·····FU 0506-2	UELFU211-201D1W3	NTN	·····FU 0359-2
UELFL209-112D1W3	NTN	·····FU 0279-2	UELFLU212D1W3	NTN	·····FU 0409-2	UELF215-47	SLB	·····FU 0506-2	UELFU211-202D1W3	NTN	·····FU 0367-2
UELFL209D1W3	NTN	·····FU 0290-2	UELFLU213-208D1W3	NTN	·····FU 0434-2	UELF215-47	SLB	·····FU 0506-2	UELFU211-203D1W3	NTN	·····FU 0386-2
UELFL210-113D1W3	NTN	·····FU 0301-2	UELFLU213-209D1W3	NTN	·····FU 0450-2	UELF215-47	SLB	·····FU 0506-2	UELFU211D1W3	NTN	·····FU 0378-2
UELFL210-114D1W3	NTN	·····FU 0310-2	UELFLU213D1W3	NTN	·····FU 0442-2	UELF215-47	SLB	·····FU 0506-2	UELFU212-204D1W3	NTN	·····FU 0394-2
UELFL210-115D1W3	NTN	·····FU 0319-2	UELFLU214-210D1W3	NTN	·····FU 0458-2	UELF215-47	SLB	·····FU 0506-2	UELFU212-205D1W3	NTN	·····FU 0402-2
UELFL210-200D1W3	NTN	·····FU 0344-2	UELFLU214-211D1W3	NTN	·····FU 0466-2	UELF215-47	SLB	·····FU 0506-2	UELFU212-206D1W3	NTN	·····FU 0421-2
UELFL210D1W3	NTN	·····FU 0330-2	UELFLU214-212D1W3	NTN	·····FU 0474-2	UELF215-47	SLB	·····FU 0506-2	UELFU212-207D1W3	NTN	·····FU 0429-2
UELFL211-200D1W3	NTN	·····FU 0346-2	UELFLU214D1W3	NTN	·····FU 0482-2	UELF215-47	SLB	·····FU 0506-2	UELFU212D1W3	NTN	·····FU 0413-2
UELFL211-201D1W3	NTN	·····FU 0357-2	UELF204	SLB	·····FU 0043-2	UELF215-47	SLB	·····FU 0506-2	UELFU213-208D1W3	NTN	·····FU 0437-2
UELFL211-202D1W3	NTN	·····FU 0365-2	UELF204-12	SLB	·····FU 0036-2	UELF215-47	SLB	·····FU 0506-2	UELFU213-209D1W3	NTN	·····FU 0453-2
UELFL211-203D1W3	NTN	·····FU 0384-2	UELF205	SLB	·····FU 0099-2	UELF215-47	SLB	·····FU 0506-2	UELFU213D1W3	NTN	·····FU 0445-2
UELFL211D1W3	NTN	·····FU 0375-2	UELF205-13	SLB	·····FU 0063-2	UELF215-47	SLB	·····FU 0506-2	UELFU214-210D1W3	NTN	·····FU 0461-2
UELFL212-204D1W3	NTN	·····FU 0392-2	UELF205-14	SLB	·····FU 0074-2	UELF215-47	SLB	·····FU 0506-2	UELFU214-211D1W3	NTN	·····FU 0469-2
UELFL212-205D1W3	NTN	·····FU 0400-2	UELF205-15	SLB	·····FU 0085-2	UELF215-47	SLB	·····FU 0506-2	UELFU214-212D1W3	NTN	·····FU 0477-2
UELFL212-206D1W3	NTN	·····FU 0419-2	UELF205-16	SLB	·····FU 0110-2	UELF215-47	SLB	·····FU 0506-2	UELFU214D1W3	NTN	·····FU 0485-2
UELFL212-207D1W3	NTN	·····FU 0427-2	UELF206	SLB	·····FU 0133-2	UELF215-47	SLB	·····FU 0506-2	UGF 204 + ER	NACHI	·····FU 0044-2
UELFL212D1W3	NTN	·····FU 0410-2	UELF206-17	SLB	·····FU 0111-2	UELF215-47	SLB	·····FU 0506-2	UGF 204-12 + ER	NACHI	·····FU 0037-2
UELFL213-208D1W3	NTN	·····FU 0435-2	UELF206-18	SLB	·····FU 0122-2	UELF215-47	SLB	·····FU 0506-2	UGF 205 + ER	NACHI	·····FU 0086-2
UELFL213-209D1W3	NTN	·····FU 0451-2	UELF206-19	SLB	·····FU 0147-2	UELF215-47	SLB	·····FU 0506-2	UGF 205-14 + ER	NACHI	·····FU 0064-2
UELFL213D1W3	NTN	·····FU 0443-2	UELF206-20	SLB	·····FU 0158-2	UELF215-47	SLB	·····FU 0506-2	UGF 205-15 + ER	NACHI	·····FU 0075-2
UELFL214-210D1W3	NTN	·····FU 0459-2	UELF207	SLB	·····FU 0215-2	UELF215-47	SLB	·····FU 0506-2	UGF 205-16 + ER	NACHI	·····FU 0100-2
UELFL214-211D1W3	NTN	·····FU 0467-2	UELF207-20	SLB	·····FU 0173-2	UELF215-47	SLB	·····FU 0506-2	UGF 206 + ER	NACHI	·····FU 0134-2
UELFL214-212D1W3	NTN	·····FU 0475-2	UELF207-21	SLB	·····FU 0186-2	UELF215-47	SLB	·····FU 0506-2	UGF 206-18 + ER	NACHI	·····FU 0123-2
UELFL214D1W3	NTN	·····FU 0483-2	UELF207-22	SLB	·····FU 0201-2	UELF215-47	SLB	·····FU 0506-2	UGF 206-19 + ER	NACHI	·····FU 0148-2
UELFL215-213D1W3	NTN	·····FU 0490-2	UELF207-23	SLB	·····FU 0226-2	UELF215-47	SLB	·····FU 0506-2	UGF 206-20 + ER	NACHI	·····FU 0159-2
UELFL215-214D1W3	NTN	·····FU 0497-2	UELF208	SLB	·····FU 0245-2	UELF215-47	SLB	·····FU 0506-2	UGF 207 + ER	NACHI	·····FU 0202-2
UELFL215-215D1W3	NTN	·····FU 0504-2	UELF208-24	SLB	·····FU 0227-2	UELF215-47	SLB	·····FU 0506-2	UGF 207-20 + ER	NACHI	·····FU 0162-2
UELFL215-300D1W3	NTN	·····FU 0518-2	UELF208-25	SLB	·····FU 0236-2	UELF215-47	SLB	·····FU 0506-2	UGF 207-21 + ER	NACHI	·····FU 0180-2
UELFL215D1W3	NTN	·····FU 0511-2	UELF209	SLB	·····FU 0295-2	UELF215-47	SLB	·····FU 0506-2	UGF 207-22 + ER	NACHI	·····FU 0191-2
UELFLU204-012D1W3	NTN	·····FU 0041-2	UELF209-26	SLB	·····FU 0265-2	UELF215-47	SLB	·····FU 0506-2	UGF 207-23 + ER	NACHI	·····FU 0216-2
UELFLU204D1W3	NTN	·····FU 0049-2	UELF209-27	SLB	·····FU 0274-2	UELF215-47	SLB	·····FU 0506-2	UGF 208 + ER	NACHI	·····FU 0246-2
UELFLU205-013D1W3	NTN	·····FU 0059-2	UELF209-28	SLB	·····FU 0283-2	UELF215-47	SLB	·····FU 0506-2	UGF 208-24 + ER	NACHI	·····FU 0228-2
UELFLU205-014D1W3	NTN	·····FU 0070-2	UELF210	SLB	·····FU 0334-2	UELF215-47	SLB	·····FU 0506-2	UGF 208-25 + ER	NACHI	·····FU 0237-2
UELFLU205-015D1W3	NTN	·····FU 0081-2	UELF210-29	SLB	·····FU 0304-2	UELF215-47	SLB	·····FU 0506-2	UGF 209 + ER	NACHI	·····FU 0284-2
UELFLU205-100D1W3	NTN	·····FU 0106-2	UELF210-30	SLB	·····FU 0313-2	UELF215-47	SLB	·····FU 0506-2	UGF 209-26 + ER	NACHI	·····FU 0257-2
UELFLU205D1W3	NTN	·····FU 0093-2	UELF210-31	SLB	·····FU 0322-2	UELF215-47	SLB	·····FU 0506-2	UGF 209-27 + ER	NACHI	·····FU 0266-2
UELFLU206-101D1W3	NTN	·····FU 0118-2	UELF210-32	SLB	·····FU 0350-2	UELF215-47	SLB	·····FU 0506-2	UGF 209-28 + ER	NACHI	·····FU 0275-2
UELFLU206-102D1W3	NTN	·····FU 0129-2	UELF211	SLB	·····FU 0378-2	UELF215-47	SLB	·····FU 0506-2	UGF 210 + ER	NACHI	·····FU 0323-2
UELFLU206-103D1W3	NTN	·····FU 0154-2	UELF211-32	SLB	·····FU 0351-2	UELF215-47	SLB	·····FU 0506-2	UGF 210-30 + ER	NACHI	·····FU 0305-2
UELFLU206-104D1W3	NTN	·····FU 0171-2	UELF211-33	SLB	·····FU 0359-2	UELF215-47	SLB	·····FU 0506-2	UGF 210-31 + ER	NACHI	·····FU 0314-2
UELFLU206D1W3	NTN	·····FU 0142-2	UELF211-34	SLB	·····FU 0367-2	UELF215-47	SLB	·····FU 0506-2	UGF 211 + ER	NACHI	·····FU 0368-2
UELFLU207-104D1W3	NTN	·····FU 0173-2	UELF211-35	SLB	·····FU 0386-2	UELF215-47	SLB	·····FU 0506-2	UGF 211-32 + ER	NACHI	·····FU 0336-2
UELFLU207-105D1W3	NTN	·····FU 0186-2	UELF212	SLB	·····FU 0413-2	UELF215-47	SLB	·····FU 0506-2	UGF 211-34 + ER	NACHI	·····FU 0360-2
UELFLU207-106D1W3	NTN	·····FU 0197-2	UELF212-36	SLB	·····FU 0391-2	UELF215-47	SLB	·····FU 0506-2	UGF 211-35 + ER	NACHI	·····FU 0379-2
UELFLU207-107D1W3	NTN	·····FU 0222-2	UELF212-37	SLB	·····FU 0402-2	UELF215-47	SLB	·····FU 0506-2	UGF 212 + ER	NACHI	·····FU 0403-2
UELFLU207D1W3	NTN	·····FU 0210-2	UELF212-38	SLB	·····FU 0421-2	UELF215-47	SLB	·····FU 0506-2	UGF 212-36 + ER	NACHI	·····FU 0387-2
UELFLU208-108D1W3	NTN	·····FU 0232-2	UELF212-39	SLB	·····FU 0429-2	UELF215-47	SLB	·····FU 0506-2	UGF 212-38 + ER	NACHI	·····FU 0414-2

BY PART NUMBER

BY PART NUMBER

Part No.	Brand	Group No.	Part No.	Brand	Group No.	Part No.	Brand	Group No.	Part No.	Brand	Group No.
UGF 212-39 + ER	NACHI	FU 0422-2	UKF 205	SLB	FU 0045-1	UKFC 208	SLB	FU 0209-1	UKFL 213	NSK	FU 0411-1
UGFC 204 + ER	NACHI	FU 0048-2	UKF 205	ASAHI	FU 0045-1	UKFC 208	FYH	FU 0209-1	UKFL205D1	NTN	FU 0052-1
UGFC 204-12 + ER	NACHI	FU 0040-2	UKF 205	FYH	FU 0045-1	UKFC 208	NACHI	FU 0209-1	UKFL206D1	NTN	FU 0097-1
UGFC 205 + ER	NACHI	FU 0092-2	UKF 205	NACHI	FU 0045-1	UKFC 208	NSK	FU 0209-1	UKFL207D1	NTN	FU 0144-1
UGFC 205-14 + ER	NACHI	FU 0069-2	UKF 205	NSK	FU 0045-1	UKFC 209	SLB	FU 0251-1	UKFL208D1	NTN	FU 0213-1
UGFC 205-15 + ER	NACHI	FU 0080-2	UKF 206	SLB	FU 0091-1	UKFC 209	FYH	FU 0251-1	UKFL209D1	NTN	FU 0254-1
UGFC 205-16 + ER	NACHI	FU 0105-2	UKF 206	ASAHI	FU 0091-1	UKFC 209	NACHI	FU 0251-1	UKFL210D1	NTN	FU 0292-1
UGFC 206 + ER	NACHI	FU 0140-2	UKF 206	FYH	FU 0091-1	UKFC 209	NSK	FU 0251-1	UKFL211D1	NTN	FU 0331-1
UGFC 206-18 + ER	NACHI	FU 0128-2	UKF 206	NACHI	FU 0091-1	UKFC 210	SLB	FU 0289-1	UKFL212D1	NTN	FU 0377-1
UGFC 206-19 + ER	NACHI	FU 0153-2	UKF 206	NSK	FU 0091-1	UKFC 210	FYH	FU 0289-1	UKFL213D1	NTN	FU 0411-1
UGFC 206-20 + ER	NACHI	FU 0167-2	UKF 207	SLB	FU 0137-1	UKFC 210	NACHI	FU 0289-1	ULFL 201	NSK	FU 0005-1
UGFC 207 + ER	NACHI	FU 0208-2	UKF 207	ASAHI	FU 0137-1	UKFC 210	NSK	FU 0289-1	ULFL 201-8S	NSK	FU 0010-1
UGFC 207-20 + ER	NACHI	FU 0170-2	UKF 207	FYH	FU 0137-1	UKFC 211	SLB	FU 0328-1	ULFL 202	NSK	FU 0020-1
UGFC 207-21 + ER	NACHI	FU 0185-2	UKF 207	NACHI	FU 0137-1	UKFC 211	FYH	FU 0328-1	ULFL 202-10S	NSK	FU 0025-1
UGFC 207-22 + ER	NACHI	FU 0196-2	UKF 207	NSK	FU 0137-1	UKFC 211	NACHI	FU 0328-1	ULFL 203	NSK	FU 0030-1
UGFC 207-23 + ER	NACHI	FU 0221-2	UKF 208	SLB	FU 0207-1	UKFC 211	NSK	FU 0328-1	ULFL 204	NSK	FU 0050-1
UGFC 208 + ER	NACHI	FU 0250-2	UKF 208	ASAHI	FU 0207-1	UKFC 212	SLB	FU 0373-1	ULFL 204-12S	NSK	FU 0042-1
UGFC 208-24 + ER	NACHI	FU 0231-2	UKF 208	FYH	FU 0207-1	UKFC 212	FYH	FU 0373-1	ULFL 205	NSK	FU 0094-1
UGFC 208-25 + ER	NACHI	FU 0240-2	UKF 208	NACHI	FU 0207-1	UKFC 212	NACHI	FU 0373-1	ULFL 205-14S	NSK	FU 0071-1
UGFC 209 + ER	NACHI	FU 0288-2	UKF 208	NSK	FU 0207-1	UKFC 212	NSK	FU 0373-1	ULFL 205-16S	NSK	FU 0107-1
UGFC 209-26 + ER	NACHI	FU 0260-2	UKF 209	SLB	FU 0247-1	UKFC 213	SLB	FU 0408-1	ULFL 206	NSK	FU 0143-1
UGFC 209-27 + ER	NACHI	FU 0269-2	UKF 209	ASAHI	FU 0247-1	UKFC 213	NACHI	FU 0408-1	ULFL 206-18S	NSK	FU 0130-1
UGFC 209-28 + ER	NACHI	FU 0278-2	UKF 209	FYH	FU 0247-1	UKFC 213	NSK	FU 0408-1	ULFL 207	NSK	FU 0211-1
UGFC 210 + ER	NACHI	FU 0327-2	UKF 209	NACHI	FU 0247-1	UKFC205D1	NTN	FU 0051-1	ULFL 207-20S	NSK	FU 0174-1
UGFC 210-30 + ER	NACHI	FU 0308-2	UKF 209	NSK	FU 0247-1	UKFC206D1	NTN	FU 0095-1	ULFL 207-22S	NSK	FU 0198-1
UGFC 210-31 + ER	NACHI	FU 0317-2	UKF 210	SLB	FU 0285-1	UKFC207D1	NTN	FU 0141-1	ULFL 208	NSK	FU 0253-1
UGFC 211 + ER	NACHI	FU 0372-2	UKF 210	ASAHI	FU 0285-1	UKFC208D1	NTN	FU 0209-1	ULFL 208-24S	NSK	FU 0233-1
UGFC 211-32 + ER	NACHI	FU 0342-2	UKF 210	FYH	FU 0285-1	UKFC209D1	NTN	FU 0251-1	ULFL 209	NSK	FU 0290-1
UGFC 211-34 + ER	NACHI	FU 0363-2	UKF 210	NACHI	FU 0285-1	UKFC210D1	NTN	FU 0289-1	ULFL 209-26S	NSK	FU 0261-1
UGFC 211-35 + ER	NACHI	FU 0382-2	UKF 210	NSK	FU 0285-1	UKFC211D1	NTN	FU 0328-1	ULFL 209-28S	NSK	FU 0279-1
UGFC 212 + ER	NACHI	FU 0407-2	UKF 211	SLB	FU 0324-1	UKFC212D1	NTN	FU 0373-1	ULFL 210	NSK	FU 0330-1
UGFC 212-36 + ER	NACHI	FU 0390-2	UKF 211	ASAHI	FU 0324-1	UKFC213D1	NTN	FU 0408-1	ULFL 210-30S	NSK	FU 0310-1
UGFC 212-38 + ER	NACHI	FU 0417-2	UKF 211	FYH	FU 0324-1	UKFL 205	SLB	FU 0052-1	ULFL 211	NSK	FU 0375-1
UGFC 212-39 + ER	NACHI	FU 0425-2	UKF 211	NACHI	FU 0324-1	UKFL 205	FYH	FU 0052-1	ULFL 211-32S	NSK	FU 0346-1
UGFL 204 + ER	NACHI	FU 0050-2	UKF 211	NSK	FU 0324-1	UKFL 205	NACHI	FU 0052-1	ULFL 211-34S	NSK	FU 0365-1
UGFL 204-12 + ER	NACHI	FU 0042-2	UKF 212	SLB	FU 0370-1	UKFL 205	NSK	FU 0052-1	ULFL 212	NSK	FU 0410-1
UGFL 205 + ER	NACHI	FU 0094-2	UKF 212	ASAHI	FU 0370-1	UKFL 206	SLB	FU 0097-1	ULFL 212-36S	NSK	FU 0392-1
UGFL 205-14 + ER	NACHI	FU 0071-2	UKF 212	FYH	FU 0370-1	UKFL 206	FYH	FU 0097-1	ULFL 212-38S	NSK	FU 0419-1
UGFL 205-15 + ER	NACHI	FU 0082-2	UKF 212	NACHI	FU 0370-1	UKFL 206	NACHI	FU 0097-1	ULFL 213	NSK	FU 0443-1
UGFL 205-16 + ER	NACHI	FU 0107-2	UKF 212	NSK	FU 0370-1	UKFL 206	NSK	FU 0097-1	ULFL 213-40S	NSK	FU 0435-1
UGFL 206 + ER	NACHI	FU 0143-2	UKF 213	SLB	FU 0404-1	UKFL 207	SLB	FU 0144-1	ULFL 214	NSK	FU 0483-1
UGFL 206-18 + ER	NACHI	FU 0130-2	UKF 213	ASAHI	FU 0404-1	UKFL 207	FYH	FU 0144-1	ULFL 214-44S	NSK	FU 0475-1
UGFL 206-19 + ER	NACHI	FU 0155-2	UKF 213	FYH	FU 0404-1	UKFL 207	NACHI	FU 0144-1	ULFL 215	NSK	FU 0511-1
UGFL 206-20 + ER	NACHI	FU 0172-2	UKF 213	NACHI	FU 0404-1	UKFL 207	NSK	FU 0144-1	ULFL 215-48S	NSK	FU 0518-1
UGFL 207 + ER	NACHI	FU 0211-2	UKF 213	NSK	FU 0404-1	UKFL 208	SLB	FU 0213-1	ULFL 216	NSK	FU 0537-1
UGFL 207-20 + ER	NACHI	FU 0174-2	UKF 213	FYH	FU 0408-1	UKFL 208	FYH	FU 0213-1	ULFL 216-50S	NSK	FU 0531-1
UGFL 207-21 + ER	NACHI	FU 0187-2	UKF205D1	NTN	FU 0045-1	UKFL 208	NACHI	FU 0213-1	ULFL 217	NSK	FU 0550-1
UGFL 207-22 + ER	NACHI	FU 0198-2	UKF206D1	NTN	FU 0091-1	UKFL 208	NSK	FU 0213-1	ULFL 217-52S	NSK	FU 0544-1
UGFL 207-23 + ER	NACHI	FU 0223-2	UKF207D1	NTN	FU 0137-1	UKFL 209	SLB	FU 0254-1	ULFL 218	NSK	FU 0559-1
UGFL 208 + ER	NACHI	FU 0253-2	UKF208D1	NTN	FU 0207-1	UKFL 209	FYH	FU 0254-1	ULFL 218-56S	NSK	FU 0556-1
UGFL 208-24 + ER	NACHI	FU 0233-2	UKF209D1	NTN	FU 0247-1	UKFL 209	NACHI	FU 0254-1	V CJ-1	FAFNIR	FU 0110-3
UGFL 208-25 + ER	NACHI	FU 0242-2	UKF210D1	NTN	FU 0285-1	UKFL 209	NSK	FU 0254-1	V CJ-1-1/16	FAFNIR	FU 0111-3
UGFL 209 + ER	NACHI	FU 0290-2	UKF211D1	NTN	FU 0324-1	UKFL 210	SLB	FU 0292-1	V CJ-1-1/2	FAFNIR	FU 0227-3
UGFL 209-26 + ER	NACHI	FU 0261-2	UKF212D1	NTN	FU 0370-1	UKFL 210	FYH	FU 0292-1	V CJ-1-1/4S	FAFNIR	FU 0158-3
UGFL 209-27 + ER	NACHI	FU 0270-2	UKF213D1	NTN	FU 0404-1	UKFL 210	NACHI	FU 0292-1	V CJ-1-1/4S	FAFNIR	FU 0179-3
UGFL 209-28 + ER	NACHI	FU 0279-2	UKFC 205	SLB	FU 0051-1	UKFL 210	NSK	FU 0292-1	V CJ-1-1/8	FAFNIR	FU 0122-3
UGFL 210 + ER	NACHI	FU 0330-2	UKFC 205	FYH	FU 0051-1	UKFL 211	SLB	FU 0331-1	V CJ-1-11/16	FAFNIR	FU 0274-3
UGFL 210-30 + ER	NACHI	FU 0310-2	UKFC 205	NACHI	FU 0051-1	UKFL 211	FYH	FU 0331-1	V CJ-1-13/16	FAFNIR	FU 0304-3
UGFL 210-31 + ER	NACHI	FU 0319-2	UKFC 205	NSK	FU 0051-1	UKFL 211	NACHI	FU 0331-1	V CJ-1-15/16	FAFNIR	FU 0322-3
UGFL 211 + ER	NACHI	FU 0375-2	UKFC 206	SLB	FU 0095-1	UKFL 211	NSK	FU 0331-1	V CJ-13/16	FAFNIR	FU 0063-3
UGFL 211-32 + ER	NACHI	FU 0346-2	UKFC 206	FYH	FU 0095-1	UKFL 212	SLB	FU 0377-1	V CJ-1-3/16	FAFNIR	FU 0147-3
UGFL 211-34 + ER	NACHI	FU 0365-2	UKFC 206	NACHI	FU 0095-1	UKFL 212	FYH	FU 0377-1	V CJ-1-3/4	FAFNIR	FU 0283-3
UGFL 211-35 + ER	NACHI	FU 0384-2	UKFC 206	NSK	FU 0095-1	UKFL 212	NACHI	FU 0377-1	V CJ-1-3/8	FAFNIR	FU 0201-3
UGFL 212 + ER	NACHI	FU 0410-2	UKFC 207	SLB	FU 0141-1	UKFL 212	NSK	FU 0377-1	V CJ-15/16	FAFNIR	FU 0085-3
UGFL 212-36 + ER	NACHI	FU 0392-2	UKFC 207	FYH	FU 0141-1	UKFL 213	SLB	FU 0411-1	V CJ-1-5/16	FAFNIR	FU 0190-3
UGFL 212-38 + ER	NACHI	FU 0419-2	UKFC 207	NACHI	FU 0141-1	UKFL 213	FYH	FU 0411-1	V CJ-1-5/8	FAFNIR	FU 0265-3
UGFL 212-39 + ER	NACHI	FU 0427-2	UKFC 207	NSK	FU 0141-1	UKFL 213	NACHI	FU 0411-1	V CJ-1-7/16	FAFNIR	FU 0226-3

BY PART NUMBER

Part No.	Brand	Group No.	Part No.	Brand	Group No.	Part No.	Brand	Group No.
VCJ-1-7/8	FAFNIR	FU 0313-3	VF2E-220S	BROWNING	FU 0171-2	VF4E-232	BROWNING	FU 0351-2
VCJ-1-9/16	FAFNIR	FU 0236-3	VF2E-222	BROWNING	FU 0197-2	VF4E-235	BROWNING	FU 0386-2
VCJ-2	FAFNIR	FU 0351-3	VF2E-223	BROWNING	FU 0222-2	VF4E-236	BROWNING	FU 0394-2
VCJ-20	FAFNIR	FU 0043-3	VF2E-224	BROWNING	FU 0232-2	VF4E-239	BROWNING	FU 0429-2
VCJ-2-1/16	FAFNIR	FU 0359-3	VF2E-226	BROWNING	FU 0262-2	VF4E-243	BROWNING	FU 0469-2
VCJ-2-1/8	FAFNIR	FU 0367-3	VF2E-227	BROWNING	FU 0271-2	VF4E-247	BROWNING	FU 0506-2
VCJ-2-3/16	FAFNIR	FU 0386-3	VF2E-228	BROWNING	FU 0280-2	VF4S-112	BROWNING	FU 0037-4
VCJ-25	FAFNIR	FU 0099-3	VF2E-231	BROWNING	FU 0318-2	VF4S-114	BROWNING	FU 0064-4
VCJ-2S	FAFNIR	FU 0350-3	VF2E-232	BROWNING	FU 0345-2	VF4S-115	BROWNING	FU 0075-4
VCJ-3/4	FAFNIR	FU 0036-3	VF2E-235	BROWNING	FU 0383-2	VF4S-116	BROWNING	FU 0100-4
VCJ-30	FAFNIR	FU 0133-3	VF2E-236	BROWNING	FU 0391-2	VF4S-118	BROWNING	FU 0123-4
VCJ-35	FAFNIR	FU 0215-3	VF2E-239	BROWNING	FU 0426-2	VF4S-119	BROWNING	FU 0148-4
VCJ-40	FAFNIR	FU 0245-3	VF2E-243	BROWNING	FU 0466-2	VF4S-120S	BROWNING	FU 0159-4
VCJ-45	FAFNIR	FU 0295-3	VF2S-112	BROWNING	FU 0042-4	VF4S-122	BROWNING	FU 0191-4
VCJ-50	FAFNIR	FU 0334-3	VF2S-114	BROWNING	FU 0071-4	VF4S-123	BROWNING	FU 0216-4
VCJ-55	FAFNIR	FU 0378-3	VF2S-115	BROWNING	FU 0082-4	VF4S-212	BROWNING	FU 0037-1
VCJ-7/8	FAFNIR	FU 0074-3	VF2S-116	BROWNING	FU 0107-4	VF4S-214	BROWNING	FU 0064-1
VCJT-1	FAFNIR	FU 0106-3	VF2S-118	BROWNING	FU 0130-4	VF4S-215	BROWNING	FU 0075-1
VCJT-1-1/16	FAFNIR	FU 0118-3	VF2S-119	BROWNING	FU 0155-4	VF4S-216	BROWNING	FU 0100-1
VCJT-1-1/2	FAFNIR	FU 0232-3	VF2S-120S	BROWNING	FU 0172-4	VF4S-218	BROWNING	FU 0123-1
VCJT-1-1/4	FAFNIR	FU 0173-3	VF2S-122	BROWNING	FU 0198-4	VF4S-219	BROWNING	FU 0148-1
VCJT-1-1/4S	FAFNIR	FU 0171-3	VF2S-123	BROWNING	FU 0223-4	VF4S-220	BROWNING	FU 0162-1
VCJT-1-1/8	FAFNIR	FU 0129-3	VF2S-212	BROWNING	FU 0042-1	VF4S-220S	BROWNING	FU 0159-1
VCJT-1-11/16	FAFNIR	FU 0271-3	VF2S-214	BROWNING	FU 0071-1	VF4S-222	BROWNING	FU 0191-1
VCJT-1-13/16	FAFNIR	FU 0300-3	VF2S-215	BROWNING	FU 0082-1	VF4S-223	BROWNING	FU 0216-1
VCJT-1-15/16	FAFNIR	FU 0318-3	VF2S-216	BROWNING	FU 0107-1	VF4S-224	BROWNING	FU 0228-1
VCJT-13/16	FAFNIR	FU 0059-3	VF2S-218	BROWNING	FU 0130-1	VF4S-226	BROWNING	FU 0257-1
VCJT-1-3/4	FAFNIR	FU 0280-3	VF2S-219	BROWNING	FU 0155-1	VF4S-227	BROWNING	FU 0266-1
VCJT-1-3/8	FAFNIR	FU 0197-3	VF2S-220	BROWNING	FU 0174-1	VF4S-228	BROWNING	FU 0275-1
VCJT-15/16	FAFNIR	FU 0081-3	VF2S-220S	BROWNING	FU 0172-1	VF4S-231	BROWNING	FU 0314-1
VCJT-1-5/16	FAFNIR	FU 0186-3	VF2S-222	BROWNING	FU 0198-1	VF4S-232	BROWNING	FU 0336-1
VCJT-1-5/8	FAFNIR	FU 0262-3	VF2S-223	BROWNING	FU 0223-1	VF4S-235	BROWNING	FU 0379-1
VCJT-1-7/16	FAFNIR	FU 0222-3	VF2S-224	BROWNING	FU 0233-1	VF4S-236	BROWNING	FU 0387-1
VCJT-1-7/8	FAFNIR	FU 0309-3	VF2S-226	BROWNING	FU 0261-1	VF4S-239	BROWNING	FU 0422-1
VCJT-1-9/16	FAFNIR	FU 0241-3	VF2S-227	BROWNING	FU 0270-1	VF4S-243	BROWNING	FU 0462-1
VCJT-2	FAFNIR	FU 0345-3	VF2S-228	BROWNING	FU 0279-1	VF4S-247	BROWNING	FU 0501-1
VCJT-20	FAFNIR	FU 0049-3	VF2S-231	BROWNING	FU 0319-1	VF4S-316	BROWNING	FU 0104-1
VCJT-2-1/16	FAFNIR	FU 0356-3	VF2S-232	BROWNING	FU 0346-1	VF4S-319	BROWNING	FU 0151-1
VCJT-2-1/8	FAFNIR	FU 0364-3	VF2S-235	BROWNING	FU 0384-1	VF4S-323	BROWNING	FU 0220-1
VCJT-2-3/16	FAFNIR	FU 0383-3	VF2S-236	BROWNING	FU 0392-1	VF4S-324	BROWNING	FU 0229-1
VCJT-25	FAFNIR	FU 0093-3	VF2S-239	BROWNING	FU 0427-1	VF4S-327	BROWNING	FU 0267-1
VCJT-2S	FAFNIR	FU 0343-3	VF2S-243	BROWNING	FU 0467-1	VF4S-328	BROWNING	FU 0276-1
VCJT-3/16	FAFNIR	FU 0154-3	VF2S-247	BROWNING	FU 0504-1	VF4S-331	BROWNING	FU 0315-1
VCJT-3/4	FAFNIR	FU 0041-3	VF4E-112	BROWNING	FU 0037-3	VF4S-332	BROWNING	FU 0341-1
VCJT-30	FAFNIR	FU 0142-3	VF4E-114	BROWNING	FU 0064-3	VF4S-335	BROWNING	FU 0381-1
VCJT-35	FAFNIR	FU 0210-3	VF4E-115	BROWNING	FU 0075-3	VF4S-339	BROWNING	FU 0423-1
VCJT-40	FAFNIR	FU 0252-3	VF4E-116	BROWNING	FU 0100-3	VF4S-340	BROWNING	FU 0431-1
VCJT-45	FAFNIR	FU 0291-3	VF4E-118	BROWNING	FU 0123-3	VF4S-343	BROWNING	FU 0463-1
VCJT-50	FAFNIR	FU 0329-3	VF4E-119	BROWNING	FU 0148-3	VF4S-347	BROWNING	FU 0500-1
VCJT-55	FAFNIR	FU 0374-3	VF4E-120S	BROWNING	FU 0159-3	VF4S-348	BROWNING	FU 0514-1
VCJT-7/8	FAFNIR	FU 0070-3	VF4E-122	BROWNING	FU 0191-3			
VF2E-112	BROWNING	FU 0042-3	VF4E-123	BROWNING	FU 0216-3			
VF2E-114	BROWNING	FU 0071-3	VF4E-212	BROWNING	FU 0036-2			
VF2E-115	BROWNING	FU 0082-3	VF4E-214	BROWNING	FU 0074-2			
VF2E-116	BROWNING	FU 0107-3	VF4E-215	BROWNING	FU 0085-2			
VF2E-118	BROWNING	FU 0130-3	VF4E-216	BROWNING	FU 0110-2			
VF2E-119	BROWNING	FU 0155-3	VF4E-218	BROWNING	FU 0122-2			
VF2E-120S	BROWNING	FU 0172-3	VF4E-219	BROWNING	FU 0147-2			
VF2E-122	BROWNING	FU 0198-3	VF4E-220	BROWNING	FU 0179-2			
VF2E-123	BROWNING	FU 0223-3	VF4E-220S	BROWNING	FU 0158-2			
VF2E-212	BROWNING	FU 0041-2	VF4E-222	BROWNING	FU 0201-2			
VF2E-214	BROWNING	FU 0070-2	VF4E-223	BROWNING	FU 0226-2			
VF2E-215	BROWNING	FU 0081-2	VF4E-224	BROWNING	FU 0227-2			
VF2E-216	BROWNING	FU 0106-2	VF4E-226	BROWNING	FU 0265-2			
VF2E-218	BROWNING	FU 0129-2	VF4E-227	BROWNING	FU 0274-2			
VF2E-219	BROWNING	FU 0154-2	VF4E-228	BROWNING	FU 0283-2			
VF2E-220	BROWNING	FU 0173-2	VF4E-231	BROWNING	FU 0322-2			

BY PART NUMBER

Part No.	Brand	Group No.	Part No.	Brand	Group No.	Part No.	Brand	Group No.	Part No.	Brand	Group No.
EWT 204	NSK	OT 0126-2	RHEY 1 1/4"	INA	OT 0078-1	RTUE 45 AH01	INA	OT 0176-2	SAST 208	SLB	OT 0166-3
EWT 205	NSK	OT 0135-2	RHEY 1 1/4"-206	INA	OT 0077-1	RTUE 50 AH01	INA	OT 0185-2	SAST 208-24	SLB	OT 0162-3
EWT 206	NSK	OT 0144-2	RHEY 1 1/8"	INA	OT 0074-1	RTUE 55 AH01	INA	OT 0195-2	SAST 208-25	SLB	OT 0164-3
EWT 207	NSK	OT 0157-2	RHEY 1 15/16"	INA	OT 0092-1	RTUE 60 AH01	INA	OT 0204-2	SAST 209	SLB	OT 0175-3
EWT 208	NSK	OT 0167-2	RHEY 1 3/4"	INA	OT 0088-1	RTUE 7/8" AH01	INA	OT 0131-2	SAST 209-26	SLB	OT 0169-3
EWT 209	NSK	OT 0176-2	RHEY 1 3/8"	INA	OT 0080-1	RTUE 70 S AH01	INA	OT 0223-2	SAST 209-27	SLB	OT 0171-3
EWT 210	NSK	OT 0185-2	RHEY 1"	INA	OT 0072-1	RTUE 75 S AH01	INA	OT 0231-2	SAST 209-28	SLB	OT 0173-3
EWT 211	NSK	OT 0195-2	RHEY 3/4"	INA	OT 0066-1	RTUY 1 1/2"	INA	OT 0163-1	SAST 210	SLB	OT 0184-3
EWT 212	NSK	OT 0204-2	RHEY 7/8"	INA	OT 0069-1	RTUY 1 1/4"	INA	OT 0150-1	SAST 210-29	SLB	OT 0178-3
EWT 213	NSK	OT 0213-2	RTU-1	FAFNIR	OT 0139-2	RTUY 1 1/4"-206	INA	OT 0149-1	SAST 210-30	SLB	OT 0180-3
GARAT 012 MAJ	KOYO	OT 0126-3	RTU-1-1/16	FAFNIR	OT 0141-2	RTUY 1 1/8"	INA	OT 0142-1	SAST 210-31	SLB	OT 0182-3
GARAT 100 MAJ	KOYO	OT 0135-3	RTU-1-1/2	FAFNIR	OT 0162-2	RTUY 1 15/16"	INA	OT 0183-1	SAST 211	SLB	OT 0197-3
GARAT 103 MAJ	KOYO	OT 0144-3	RTU-1-1/4	FAFNIR	OT 0152-2	RTUY 1 3/4"	INA	OT 0174-1	SAST 211-32	SLB	OT 0190-3
GARAT 106 MAJ	KOYO	OT 0157-3	RTU-1-1/8	FAFNIR	OT 0143-2	RTUY 1"	INA	OT 0138-1	SAST 211-33	SLB	OT 0192-3
GARAT 109 MAJ	KOYO	OT 0167-3	RTU-1-11/16	FAFNIR	OT 0171-2	RTUY 2 15/16"	INA	OT 0229-1	SAST 211-34	SLB	OT 0194-3
GARAT 112 MAJ	KOYO	OT 0176-3	RTU-1-13/16	FAFNIR	OT 0178-2	RTUY 2 7/16"	INA	OT 0209-1	SAST 211-35	SLB	OT 0199-3
GARAT 115 MAJ	KOYO	OT 0185-3	RTU-1-15/16	FAFNIR	OT 0182-2	RTUY 2"	INA	OT 0189-1	SAT 204	SLB	OT 0126-3
GAT 1012 MBJ	KOYO	OT 0126-2	RTU-13/16	FAFNIR	OT 0130-2	RTUY 20	INA	OT 0126-1	SAT 204-12	SLB	OT 0124-3
GAT 1100 MBJ	KOYO	OT 0135-2	RTU-1-3/16	FAFNIR	OT 0148-2	RTUY 25	INA	OT 0135-1	SAT 205	SLB	OT 0135-3
GAT 1103 MBJ	KOYO	OT 0144-2	RTU-1-3/4	FAFNIR	OT 0173-2	RTUY 3/4"	INA	OT 0124-1	SAT 205-13	SLB	OT 0129-3
GAT 1106 MBJ	KOYO	OT 0157-2	RTU-1-3/8	FAFNIR	OT 0156-2	RTUY 30	INA	OT 0144-1	SAT 205-14	SLB	OT 0131-3
GAT 1109 MBJ	KOYO	OT 0167-2	RTU-15/16	FAFNIR	OT 0134-2	RTUY 35	INA	OT 0157-1	SAT 205-15	SLB	OT 0133-3
GAT 1112 MBJ	KOYO	OT 0176-2	RTU-1-5/16	FAFNIR	OT 0154-2	RTUY 40	INA	OT 0167-1	SAT 205-16	SLB	OT 0138-3
GAT 1115 MBJ	KOYO	OT 0185-2	RTU-1-5/8	FAFNIR	OT 0169-2	RTUY 45	INA	OT 0176-1	SAT 206	SLB	OT 0144-3
PHE 1 1/16"	INA	OT 0073-2	RTU-1-7/16	FAFNIR	OT 0161-2	RTUY 50	INA	OT 0185-1	SAT 206-17	SLB	OT 0140-3
PHE 1 1/2"	INA	OT 0083-2	RTU-1-7/8	FAFNIR	OT 0180-2	RTUY 55	INA	OT 0195-1	SAT 206-18	SLB	OT 0142-3
PHE 1 1/4"	INA	OT 0078-2	RTU-1-9/16	FAFNIR	OT 0164-2	RTUY 60	INA	OT 0204-1	SAT 206-19	SLB	OT 0147-3
PHE 1 1/4"-206	INA	OT 0077-2	RTU-2	FAFNIR	OT 0190-2	RTUY 7/8"	INA	OT 0131-1	SAT 206-20	SLB	OT 0149-3
PHE 1 1/8"	INA	OT 0074-2	RTU-20	FAFNIR	OT 0128-2	RTUY 70	INA	OT 0223-1	SAT 207	SLB	OT 0157-3
PHE 1 15/16"	INA	OT 0092-2	RTU-2-1/16	FAFNIR	OT 0192-2	RTUY 75	INA	OT 0231-1	SAT 207-20	SLB	OT 0150-3
PHE 1 3/16"	INA	OT 0076-2	RTU-2-1/4	FAFNIR	OT 0201-2	SAHA 204	SLB	OT 0067-2	SAT 207-21	SLB	OT 0153-3
PHE 1 3/4"	INA	OT 0088-2	RTU-2-1/8	FAFNIR	OT 0194-2	SAHA 204-12	SLB	OT 0066-2	SAT 207-22	SLB	OT 0155-3
PHE 1 3/8"	INA	OT 0080-2	RTU-2-3/16	FAFNIR	OT 0199-2	SAHA 205	SLB	OT 0071-2	SAT 207-23	SLB	OT 0160-3
PHE 1 7/16"	INA	OT 0082-2	RTU-2-3/8	FAFNIR	OT 0208-2	SAHA 205-14	SLB	OT 0069-2	SAT 208	SLB	OT 0167-3
PHE 1"	INA	OT 0072-2	RTU-25	FAFNIR	OT 0136-2	SAHA 205-16	SLB	OT 0072-2	SAT 208-24	SLB	OT 0163-3
PHE 20	INA	OT 0067-2	RTU-2-5/16	FAFNIR	OT 0203-2	SAHA 206	SLB	OT 0075-2	SAT 208-25	SLB	OT 0165-3
PHE 25	INA	OT 0071-2	RTU-2-7/16	FAFNIR	OT 0210-2	SAHA 206-17	SLB	OT 0073-2	SAT 209	SLB	OT 0176-3
PHE 3/4"	INA	OT 0066-2	RTU-3/4	FAFNIR	OT 0125-2	SAHA 206-18	SLB	OT 0074-2	SAT 209-26	SLB	OT 0170-3
PHE 30	INA	OT 0075-2	RTU-30	FAFNIR	OT 0146-2	SAHA 206-19	SLB	OT 0076-2	SAT 209-27	SLB	OT 0172-3
PHE 35	INA	OT 0081-2	RTU-35	FAFNIR	OT 0158-2	SAHA 206-20	SLB	OT 0077-2	SAT 209-28	SLB	OT 0174-3
PHE 40	INA	OT 0085-2	RTU-40	FAFNIR	OT 0166-2	SAHA 207	SLB	OT 0081-2	SAT 209-29	SLB	OT 0175-3
PHE 45	INA	OT 0089-2	RTU-45	FAFNIR	OT 0175-2	SAHA 207-20	SLB	OT 0078-2	SAT 210	SLB	OT 0185-3
PHE 50	INA	OT 0093-2	RTU-50	FAFNIR	OT 0184-2	SAHA 207-22	SLB	OT 0080-2	SAT 210-30	SLB	OT 0181-3
PHE 7/8"	INA	OT 0069-2	RTU-55	FAFNIR	OT 0197-2	SAHA 207-23	SLB	OT 0082-2	SAT 210-31	SLB	OT 0183-3
PTUE 1 1/16" AH01	INA	OT 0141-3	RTU-60	FAFNIR	OT 0205-2	SAHA 208	SLB	OT 0085-2	SAT 211	SLB	OT 0195-3
PTUE 1 1/2" AH01	INA	OT 0162-3	RTU-7/8	FAFNIR	OT 0132-2	SAHA 208-24	SLB	OT 0083-2	SAT 211-32	SLB	OT 0189-3
PTUE 1 1/4" AH01	INA	OT 0152-3	RTUE 1 1/2" AH01	INA	OT 0163-2	SAHA 209	SLB	OT 0089-2	SAT 211-35	SLB	OT 0198-3
PTUE 1 1/4"-206 AH01	INA	OT 0151-3	RTUE 1 1/4" AH01	INA	OT 0150-2	SAHA 209-28	SLB	OT 0088-2	SEHB-18	SEALMASTER	OT 0074-1
PTUE 1 1/8" AH01	INA	OT 0143-3	RTUE 1 1/4"-206 AH01	INA	OT 0149-2	SAHA 210	SLB	OT 0093-2	SEHB-20	SEALMASTER	OT 0078-1
PTUE 1 15/16" AH01	INA	OT 0182-3	RTUE 1 1/8" AH01	INA	OT 0142-2	SAHA 210-31	SLB	OT 0092-2	SEHB-206	SEALMASTER	OT 0075-1
PTUE 1 3/16" AH01	INA	OT 0148-3	RTUE 1 11/16" AH01	INA	OT 0172-2	SAHA 210-31	SLB	OT 0092-2	SEHB-207	SEALMASTER	OT 0081-1
PTUE 1 3/4" AH01	INA	OT 0173-3	RTUE 1 15/16" AH01	INA	OT 0183-2	SAST 204	SLB	OT 0128-3	SEHB-208	SEALMASTER	OT 0085-1
PTUE 1 7/16" AH01	INA	OT 0161-3	RTUE 1 3/16" AH01	INA	OT 0147-2	SAST 204-12	SLB	OT 0125-3	SEHB-21	SEALMASTER	OT 0079-1
PTUE 1" AH01	INA	OT 0139-3	RTUE 1 3/4" AH01	INA	OT 0174-2	SAST 205	SLB	OT 0136-3	SEHB-212	SEALMASTER	OT 0102-1
PTUE 2 3/16" AH01	INA	OT 0199-3	RTUE 1 5/8" AH01	INA	OT 0170-2	SAST 205-13	SLB	OT 0130-3	SEHB-215	SEALMASTER	OT 0115-1
PTUE 2" AH01	INA	OT 0190-3	RTUE 1 7/16" AH01	INA	OT 0160-2	SAST 205-14	SLB	OT 0132-3	SEHB-22	SEALMASTER	OT 0080-1
PTUE 20 AH01	INA	OT 0128-3	RTUE 1" AH01	INA	OT 0138-2	SAST 205-15	SLB	OT 0134-3	SEHB-24	SEALMASTER	OT 0083-1
PTUE 25 AH01	INA	OT 0136-3	RTUE 15/16" AH01	INA	OT 0133-2	SAST 205-16	SLB	OT 0139-3	SEHB-25	SEALMASTER	OT 0084-1
PTUE 3/4" AH01	INA	OT 0125-3	RTUE 2 15/16" S AH01	INA	OT 0229-2	SAST 206	SLB	OT 0146-3	SEHB-38	SEALMASTER	OT 0103-1
PTUE 30 AH01	INA	OT 0146-3	RTUE 2 3/16" AH01	INA	OT 0198-2	SAST 206-17	SLB	OT 0141-3	SEHB-39	SEALMASTER	OT 0104-1
PTUE 35 AH01	INA	OT 0158-3	RTUE 2 7/16" AH01	INA	OT 0209-2	SAST 206-18	SLB	OT 0143-3	SEHB-47	SEALMASTER	OT 0114-1
PTUE 40 AH01	INA	OT 0166-3	RTUE 20 AH01	INA	OT 0126-2	SAST 206-19	SLB	OT 0148-3	ST1	RHP	OT 0139-1
PTUE 45 AH01	INA	OT 0175-3	RTUE 25 AH01	INA	OT 0135-2	SAST 206-20	SLB	OT 0151-3	ST1 1/2	RHP	OT 0162-1
PTUE 50 AH01	INA	OT 0184-3	RTUE 3/4" AH01	INA	OT 0124-2	SAST 207	SLB	OT 0158-3	ST1 1/2DEC	RHP	OT 0162-2
PTUE 55 AH01	INA	OT 0197-3	RTUE 30 AH01	INA	OT 0144-2	SAST 207-20	SLB	OT 0152-3	ST1 1/2EC	RHP	OT 0162-3
PTUE 7/8" AH01	INA	OT 0132-3	RTUE 35 AH01	INA	OT 0157-2	SAST 207-21	SLB	OT 0154-3	ST1 1/4	RHP	OT 0152-1
RHEY 1 1/2"	INA	OT 0083-1	RTUE 40 AH01	INA	OT 0167-2	SAST 207-22	SLB	OT 0156-3	ST1 1/4DEC	RHP	OT 0152-2
						SAST 207-23	SLB	OT 0161-3	ST1 1/4DECR	RHP	OT 0151-2

BY PART NUMBER

Part No.	Brand	Group No.	Part No.	Brand	Group No.	Part No.	Brand	Group No.	Part No.	Brand	Group No.
ST1 1/4EC	RHP	OT 0152-3	ST-204	SEALMASTER	OT 0128-1	ST55DEC	RHP	OT 0197-2	TBY 2 TM	SKF	OT 0189-1
ST1 1/4ECR	RHP	OT 0151-3	ST205	SEALMASTER	OT 0136-1	ST60	RHP	OT 0205-1	TBY 2 WM	SKF	OT 0189-2
ST1 1/4R	RHP	OT 0151-1	ST-206	SEALMASTER	OT 0146-1	ST60	SNR	OT 0205-1	TBY 20 FM	SKF	OT 0126-3
ST1 1/8	RHP	OT 0143-1	ST-207	SEALMASTER	OT 0158-1	ST60DEC	RHP	OT 0205-2	TBY 20 TM	SKF	OT 0126-1
ST1 1/8DEC	RHP	OT 0143-2	ST-208	SEALMASTER	OT 0166-1	ST65	RHP	OT 0214-1	TBY 20 WM	SKF	OT 0126-2
ST1 1/8EC	RHP	OT 0143-3	ST-209	SEALMASTER	OT 0175-1	ST65DECC	RHP	OT 0214-2	TBY 2-3/16 FM	SKF	OT 0198-3
ST1 11/16	RHP	OT 0171-1	ST20DEC	RHP	OT 0128-2	ST7/8	RHP	OT 0132-1	TBY 2-3/16 TM	SKF	OT 0198-1
ST1 11/16DEC	RHP	OT 0171-2	ST20EC	RHP	OT 0128-3	ST7/8DEC	RHP	OT 0132-2	TBY 2-3/16 WM	SKF	OT 0198-2
ST1 11/16EC	RHP	OT 0171-3	ST-20R	SEALMASTER	OT 0151-1	ST7/8EC	RHP	OT 0132-3	TBY 25 FM	SKF	OT 0135-3
ST1 15/16	RHP	OT 0182-1	ST-21	SEALMASTER	OT 0154-1	ST70	RHP	OT 0224-1	TBY 25 TM	SKF	OT 0135-1
ST1 15/16DEC	RHP	OT 0182-2	ST-210	SEALMASTER	OT 0184-1	ST70DEC	RHP	OT 0224-2	TBY 25 WM	SKF	OT 0135-2
ST1 15/16EC	RHP	OT 0182-3	ST-212	SEALMASTER	OT 0205-1	ST75	RHP	OT 0232-1	TBY 3/4 FM	SKF	OT 0124-3
ST1 3/16	RHP	OT 0148-1	ST-214	SEALMASTER	OT 0224-1	TBY 1 FM	SKF	OT 0138-3	TBY 3/4 TM	SKF	OT 0124-1
ST1 3/16DEC	RHP	OT 0148-2	ST-215	SEALMASTER	OT 0232-1	TBY 1 TM	SKF	OT 0138-1	TBY 3/4 WM	SKF	OT 0124-2
ST1 3/16EC	RHP	OT 0148-3	ST-22	SEALMASTER	OT 0156-1	TBY 1 WM	SKF	OT 0138-2	TBY 30 FM	SKF	OT 0144-3
ST1 3/4	RHP	OT 0173-1	ST-23	SEALMASTER	OT 0161-1	TBY 1-1/16 FM	SKF	OT 0140-3	TBY 30 TM	SKF	OT 0144-1
ST1 3/4DEC	RHP	OT 0173-2	ST-24	SEALMASTER	OT 0162-1	TBY 1-1/16 TM	SKF	OT 0140-1	TBY 30 WM	SKF	OT 0144-2
ST1 3/4EC	RHP	OT 0173-3	ST25	RHP	OT 0136-1	TBY 1-1/16 WM	SKF	OT 0140-2	TBY 35 FM	SKF	OT 0157-3
ST1 3/8	RHP	OT 0156-1	ST25	SNR	OT 0136-1	TBY 1-1/2 FM	SKF	OT 0163-3	TBY 35 TM	SKF	OT 0157-1
ST1 3/8DEC	RHP	OT 0156-2	ST-25	SEALMASTER	OT 0164-1	TBY 1-1/2 TM	SKF	OT 0163-1	TBY 35 WM	SKF	OT 0157-2
ST1 3/8EC	RHP	OT 0156-3	ST25DEC	RHP	OT 0136-2	TBY 1-1/2 WM	SKF	OT 0163-2	TBY 40 FM	SKF	OT 0167-3
ST1 5/8	RHP	OT 0169-1	ST25EC	RHP	OT 0136-3	TBY 1-1/4 AFM	SKF	OT 0149-3	TBY 40 TM	SKF	OT 0167-1
ST1 5/8DEC	RHP	OT 0169-2	ST-26	SEALMASTER	OT 0169-1	TBY 1-1/4 ATM	SKF	OT 0149-1	TBY 40 WM	SKF	OT 0167-2
ST1 5/8EC	RHP	OT 0169-3	ST-27	SEALMASTER	OT 0171-1	TBY 1-1/4 AWM	SKF	OT 0149-2	TBY 45 FM	SKF	OT 0176-3
ST1 7/16	RHP	OT 0161-1	ST-28	SEALMASTER	OT 0173-1	TBY 1-1/4 FM	SKF	OT 0150-3	TBY 45 TM	SKF	OT 0176-1
ST1 7/16DEC	RHP	OT 0161-2	ST-29	SEALMASTER	OT 0178-1	TBY 1-1/4 TM	SKF	OT 0150-1	TBY 45 WM	SKF	OT 0176-2
ST1 7/16EC	RHP	OT 0161-3	ST2DEC	RHP	OT 0190-2	TBY 1-1/4 WM	SKF	OT 0150-2	TBY 50 FM	SKF	OT 0185-3
ST1 7/8	RHP	OT 0180-1	ST2R	RHP	OT 0187-1	TBY 1-1/8 FM	SKF	OT 0142-3	TBY 50 TM	SKF	OT 0185-1
ST1 7/8DEC	RHP	OT 0180-2	ST3	RHP	OT 0234-1	TBY 1-1/8 TM	SKF	OT 0142-1	TBY 50 WM	SKF	OT 0185-2
ST1 7/8EC	RHP	OT 0180-3	ST3/4	RHP	OT 0125-1	TBY 1-1/8 WM	SKF	OT 0142-2	TBY 55 FM	SKF	OT 0195-3
ST-12	SEALMASTER	OT 0125-1	ST3/4DEC	RHP	OT 0125-2	TBY 1-11/16 FM	SKF	OT 0172-3	TBY 55 TM	SKF	OT 0195-1
ST-13	SEALMASTER	OT 0130-1	ST3/4EC	RHP	OT 0125-3	TBY 1-11/16 TM	SKF	OT 0172-1	TBY 55 WM	SKF	OT 0195-2
ST-14	SEALMASTER	OT 0132-1	ST30	RHP	OT 0146-1	TBY 1-11/16 WM	SKF	OT 0172-2	TBY 7/8 FM	SKF	OT 0131-3
ST-15	SEALMASTER	OT 0134-1	ST30	SNR	OT 0146-1	TBY 1-15/16 FM	SKF	OT 0183-3	TBY 7/8 TM	SKF	OT 0131-1
ST15/16	RHP	OT 0134-1	ST-30	SEALMASTER	OT 0180-1	TBY 1-15/16 TM	SKF	OT 0183-1	TBY 7/8 WM	SKF	OT 0131-2
ST15/16DEC	RHP	OT 0134-2	ST30DEC	RHP	OT 0146-2	TBY 1-15/16 WM	SKF	OT 0183-2	TH3-220N	LINK BELT	OT 0152-1
ST15/16EC	RHP	OT 0134-3	ST30EC	RHP	OT 0146-3	TBY 13/16 FM	SKF	OT 0129-3	TH3-U212N	LINK BELT	OT 0125-1
ST-16	SEALMASTER	OT 0139-1	ST-31	SEALMASTER	OT 0182-1	TBY 1-3/16 FM	SKF	OT 0147-3	TH3-U214N	LINK BELT	OT 0132-1
ST-17	SEALMASTER	OT 0141-1	ST-32R	SEALMASTER	OT 0187-1	TBY 13/16 TM	SKF	OT 0129-1	TH3-U215N	LINK BELT	OT 0134-1
ST-18	SEALMASTER	OT 0143-1	ST-32R	SEALMASTER	OT 0190-1	TBY 1-3/16 TM	SKF	OT 0147-1	TH3-U216N	LINK BELT	OT 0139-1
ST-19	SEALMASTER	OT 0148-1	ST-34	SEALMASTER	OT 0194-1	TBY 13/16 WM	SKF	OT 0129-2	TH3-U218N	LINK BELT	OT 0143-1
ST1EC	RHP	OT 0139-3	ST35	RHP	OT 0158-1	TBY 1-3/16 WM	SKF	OT 0147-2	TH3-U219N	LINK BELT	OT 0148-1
ST1EDEC	RHP	OT 0139-2	ST35	SNR	OT 0158-1	TBY 1-3/4 FM	SKF	OT 0174-3	TH3-U222N	LINK BELT	OT 0156-1
ST2	RHP	OT 0190-1	ST-35	SEALMASTER	OT 0199-1	TBY 1-3/4 TM	SKF	OT 0174-1	TH3-U223N	LINK BELT	OT 0161-1
ST2 1/2	RHP	OT 0212-1	ST35DEC	RHP	OT 0158-2	TBY 1-3/4 WM	SKF	OT 0174-2	TH3-U224N	LINK BELT	OT 0162-1
ST2 1/2DEC	RHP	OT 0212-2	ST35EC	RHP	OT 0158-3	TBY 1-3/8 FM	SKF	OT 0155-3	TH3-U226N	LINK BELT	OT 0169-1
ST2 1/4	RHP	OT 0201-1	ST-36	SEALMASTER	OT 0201-1	TBY 1-3/8 TM	SKF	OT 0155-1	TH3-U227N	LINK BELT	OT 0171-1
ST2 1/4DEC	RHP	OT 0201-2	ST-38	SEALMASTER	OT 0208-1	TBY 1-3/8 WM	SKF	OT 0155-2	TH3-U228N	LINK BELT	OT 0173-1
ST2 1/8	RHP	OT 0194-1	ST-39	SEALMASTER	OT 0210-1	TBY 15/16 FM	SKF	OT 0133-3	TH3-U231N	LINK BELT	OT 0182-1
ST2 1/8DEC	RHP	OT 0194-2	ST40	RHP	OT 0166-1	TBY 1-5/16 FM	SKF	OT 0153-3	TH3-U232N	LINK BELT	OT 0190-1
ST2 11/16	RHP	OT 0220-1	ST40	SNR	OT 0166-1	TBY 15/16 TM	SKF	OT 0133-1	TH3-U235N	LINK BELT	OT 0199-1
ST2 11/16DEC	RHP	OT 0220-2	ST-40	SEALMASTER	OT 0212-1	TBY 1-5/16 TM	SKF	OT 0153-1	TH3-U236N	LINK BELT	OT 0201-1
ST2 15/16	RHP	OT 0230-1	ST40DEC	RHP	OT 0166-2	TBY 15/16 WM	SKF	OT 0133-2	TH3-U238N	LINK BELT	OT 0208-1
ST2 15/16DEC	RHP	OT 0230-2	ST40EC	RHP	OT 0166-3	TBY 1-5/16 WM	SKF	OT 0153-2	TH3-U239N	LINK BELT	OT 0210-1
ST2 3/16	RHP	OT 0199-1	ST-43	SEALMASTER	OT 0220-1	TBY 1-5/8 FM	SKF	OT 0170-3	TH3-U2E20N	LINK BELT	OT 0151-1
ST2 3/16DEC	RHP	OT 0199-2	ST45	RHP	OT 0175-1	TBY 1-5/8 TM	SKF	OT 0170-1	TH3-U2E32N	LINK BELT	OT 0187-1
ST2 3/4	RHP	OT 0222-1	ST45	SNR	OT 0175-1	TBY 1-5/8 WM	SKF	OT 0170-2	UCC 201	SLB	FU 0001-1
ST2 3/4DEC	RHP	OT 0222-2	ST45DEC	RHP	OT 0175-2	TBY 1-7/16 FM	SKF	OT 0160-3	UCC 201	ASAHI	FU 0001-1
ST2 3/8	RHP	OT 0208-1	ST45EC	RHP	OT 0175-3	TBY 1-7/16 TM	SKF	OT 0160-1	UCC 201	FYH	FU 0001-1
ST2 3/8DEC	RHP	OT 0208-2	ST-46	SEALMASTER	OT 0228-1	TBY 1-7/16 WM	SKF	OT 0160-2	UCC 201	NACHI	FU 0001-1
ST2 7/16	RHP	OT 0210-1	ST-47	SEALMASTER	OT 0230-1	TBY 1-7/8 FM	SKF	OT 0181-3	UCC 201	NSK	FU 0001-1
ST2 7/16DEC	RHP	OT 0210-2	ST50	RHP	OT 0184-1	TBY 1-7/8 TM	SKF	OT 0181-1	UCC 201-8	SLB	OT 0002-1
ST2 7/8	RHP	OT 0228-1	ST50	SNR	OT 0184-1	TBY 1-7/8 WM	SKF	OT 0181-2	UCC 201-8	ASAHI	OT 0002-1
ST2 7/8DEC	RHP	OT 0228-2	ST50DEC	RHP	OT 0184-2	TBY 1-9/16 FM	SKF	OT 0165-3	UCC 201-8	FYH	OT 0002-1
ST20	RHP	OT 0128-1	ST50EC	RHP	OT 0184-3	TBY 1-9/16 TM	SKF	OT 0165-1	UCC 201-8	NACHI	OT 0002-1
ST20	SNR	OT 0128-1	ST55	RHP	OT 0197-1	TBY 1-9/16 WM	SKF	OT 0165-2	UCC 201-8S	NSK	OT 0002-1
ST-20	SEALMASTER	OT 0152-1	ST55	SNR	OT 0197-1	TBY 2 FM	SKF	OT 0189-3	UCC 202	SLB	OT 0004-1

BY PART NUMBER

Part No.	Brand	Group No.	Part No.	Brand	Group No.	Part No.	Brand	Group No.	Part No.	Brand	Group No.
UCC 202	ASAHI	OT 0004-1	UCC 206-20	SLB	OT 0022-1	UCC 210-30S	NSK	OT 0039-1	UCC204D1	NTN	OT 0009-1
UCC 202	FYH	OT 0004-1	UCC 207	SLB	OT 0026-1	UCC 210-31	SLB	OT 0040-1	UCC205-013D1	NTN	OT 0011-1
UCC 202	NACHI	OT 0004-1	UCC 207	ASAHI	OT 0026-1	UCC 210-31	ASAHI	OT 0040-1	UCC205-014D1	NTN	OT 0012-1
UCC 202	NSK	OT 0004-1	UCC 207	FYH	OT 0026-1	UCC 210-31	FYH	OT 0040-1	UCC205-015D1	NTN	OT 0013-1
UCC 202-10	SLB	OT 0005-1	UCC 207	NACHI	OT 0026-1	UCC 210-31	NACHI	OT 0040-1	UCC205-100D1	NTN	OT 0016-1
UCC 202-10	ASAHI	OT 0005-1	UCC 207	NSK	OT 0026-1	UCC 210-32	SLB	OT 0043-1	UCC205D1	NTN	OT 0014-1
UCC 202-10	FYH	OT 0005-1	UCC 207-20	SLB	OT 0023-1	UCC 211	SLB	OT 0047-1	UCC206-101D1	NTN	OT 0017-1
UCC 202-10	NACHI	OT 0005-1	UCC 207-20	ASAHI	OT 0023-1	UCC 211	ASAHI	OT 0047-1	UCC206-102D1	NTN	OT 0018-1
UCC 202-10S	NSK	OT 0005-1	UCC 207-20	FYH	OT 0023-1	UCC 211	FYH	OT 0047-1	UCC206-103D1	NTN	OT 0021-1
UCC 202-9	SLB	OT 0003-1	UCC 207-20	NACHI	OT 0023-1	UCC 211	NACHI	OT 0047-1	UCC206-104D1	NTN	OT 0022-1
UCC 202-9	ASAHI	OT 0003-1	UCC 207-20S	NSK	OT 0023-1	UCC 211	NSK	OT 0047-1	UCC206D1	NTN	OT 0019-1
UCC 202-9	NACHI	OT 0003-1	UCC 207-21	SLB	OT 0024-1	UCC 211-32	SLB	OT 0044-1	UCC207-104D1	NTN	OT 0023-1
UCC 203	SLB	OT 0006-1	UCC 207-21	ASAHI	OT 0024-1	UCC 211-32	ASAHI	OT 0044-1	UCC207-105D1	NTN	OT 0024-1
UCC 203	ASAHI	OT 0006-1	UCC 207-21	FYH	OT 0024-1	UCC 211-32	FYH	OT 0044-1	UCC207-106D1	NTN	OT 0025-1
UCC 203	FYH	OT 0006-1	UCC 207-21	NACHI	OT 0024-1	UCC 211-32	NACHI	OT 0044-1	UCC207-107D1	NTN	OT 0028-1
UCC 203	NACHI	OT 0006-1	UCC 207-22	SLB	OT 0025-1	UCC 211-32S	NSK	OT 0044-1	UCC207D1	NTN	OT 0026-1
UCC 203	NSK	OT 0006-1	UCC 207-22	ASAHI	OT 0025-1	UCC 211-33	SLB	OT 0045-1	UCC208-108D1	NTN	OT 0029-1
UCC 203-11	SLB	OT 0007-1	UCC 207-22	FYH	OT 0025-1	UCC 211-33	ASAHI	OT 0045-1	UCC208-109D1	NTN	OT 0030-1
UCC 203-11	ASAHI	OT 0007-1	UCC 207-22	NACHI	OT 0025-1	UCC 211-33	NACHI	OT 0045-1	UCC208D1	NTN	OT 0032-1
UCC 203-11	NACHI	OT 0007-1	UCC 207-22S	NSK	OT 0025-1	UCC 211-34	SLB	OT 0046-1	UCC209-110D1	NTN	OT 0033-1
UCC 204	SLB	OT 0009-1	UCC 207-23	SLB	OT 0028-1	UCC 211-34	ASAHI	OT 0046-1	UCC209-111D1	NTN	OT 0034-1
UCC 204	ASAHI	OT 0009-1	UCC 207-23	ASAHI	OT 0028-1	UCC 211-34	FYH	OT 0046-1	UCC209-112D1	NTN	OT 0035-1
UCC 204	FYH	OT 0009-1	UCC 207-23	FYH	OT 0028-1	UCC 211-34	NACHI	OT 0046-1	UCC209D1	NTN	OT 0036-1
UCC 204	NACHI	OT 0009-1	UCC 207-23	NACHI	OT 0028-1	UCC 211-34S	NSK	OT 0046-1	UCC210-113D1	NTN	OT 0038-1
UCC 204	NSK	OT 0009-1	UCC 208	SLB	OT 0032-1	UCC 211-35	SLB	OT 0049-1	UCC210-114D1	NTN	OT 0039-1
UCC 204-12	SLB	OT 0008-1	UCC 208	ASAHI	OT 0032-1	UCC 211-35	ASAHI	OT 0049-1	UCC210-115D1	NTN	OT 0040-1
UCC 204-12	ASAHI	OT 0008-1	UCC 208	FYH	OT 0032-1	UCC 211-35	FYH	OT 0049-1	UCC210-200D1	NTN	OT 0043-1
UCC 204-12	FYH	OT 0008-1	UCC 208	NACHI	OT 0032-1	UCC 211-35	NACHI	OT 0049-1	UCC210D1	NTN	OT 0041-1
UCC 204-12	NACHI	OT 0008-1	UCC 208	NSK	OT 0032-1	UCC 212	SLB	OT 0052-1	UCC211-200D1	NTN	OT 0044-1
UCC 204-12S	NSK	OT 0008-1	UCC 208-24	SLB	OT 0029-1	UCC 212	ASAHI	OT 0052-1	UCC211-201D1	NTN	OT 0045-1
UCC 205	SLB	OT 0014-1	UCC 208-24	ASAHI	OT 0029-1	UCC 212	FYH	OT 0052-1	UCC211-202D1	NTN	OT 0046-1
UCC 205	ASAHI	OT 0014-1	UCC 208-24	FYH	OT 0029-1	UCC 212	NACHI	OT 0052-1	UCC211-203D1	NTN	OT 0049-1
UCC 205	FYH	OT 0014-1	UCC 208-24S	NSK	OT 0029-1	UCC 212	NSK	OT 0052-1	UCC211D1	NTN	OT 0047-1
UCC 205	NACHI	OT 0014-1	UCC 208-25	SLB	OT 0030-1	UCC 212-36	SLB	OT 0050-1	UCC212-204D1	NTN	OT 0050-1
UCC 205	NSK	OT 0014-1	UCC 208-25	ASAHI	OT 0030-1	UCC 212-36	ASAHI	OT 0050-1	UCC212-205D1	NTN	OT 0051-1
UCC 205-13	SLB	OT 0011-1	UCC 208-25	FYH	OT 0030-1	UCC 212-36	FYH	OT 0050-1	UCC212-206D1	NTN	OT 0054-1
UCC 205-14	SLB	OT 0012-1	UCC 208-25	NACHI	OT 0030-1	UCC 212-36	NACHI	OT 0050-1	UCC212-207D1	NTN	OT 0055-1
UCC 205-14	ASAHI	OT 0012-1	UCC 208-25	NSK	OT 0030-1	UCC 212-36S	NSK	OT 0050-1	UCC212D1	NTN	OT 0052-1
UCC 205-14	FYH	OT 0012-1	UCC 209	SLB	OT 0036-1	UCC 212-37	SLB	OT 0051-1	UCC213-208D1	NTN	OT 0056-1
UCC 205-14	NACHI	OT 0012-1	UCC 209	ASAHI	OT 0036-1	UCC 212-38	SLB	OT 0054-1	UCC213-209D1	NTN	OT 0058-1
UCC 205-14S	NSK	OT 0012-1	UCC 209	FYH	OT 0036-1	UCC 212-38	ASAHI	OT 0054-1	UCC213D1	NTN	OT 0057-1
UCC 205-15	SLB	OT 0013-1	UCC 209	NACHI	OT 0036-1	UCC 212-38	FYH	OT 0054-1	UCECH 205	ASAHI	OT 0071-1
UCC 205-15	ASAHI	OT 0013-1	UCC 209	NSK	OT 0036-1	UCC 212-38	NACHI	OT 0054-1	UCECH 205	NACHI	OT 0071-1
UCC 205-15	FYH	OT 0013-1	UCC 209-26	SLB	OT 0033-1	UCC 212-38S	NSK	OT 0054-1	UCECH 205-14	ASAHI	OT 0069-1
UCC 205-15	NACHI	OT 0013-1	UCC 209-26	ASAHI	OT 0033-1	UCC 212-39	SLB	OT 0055-1	UCECH 205-14	NACHI	OT 0069-1
UCC 205-16	SLB	OT 0016-1	UCC 209-26	FYH	OT 0033-1	UCC 212-39	ASAHI	OT 0055-1	UCECH 205-15	ASAHI	OT 0070-1
UCC 205-16	ASAHI	OT 0016-1	UCC 209-26	NACHI	OT 0033-1	UCC 212-39	FYH	OT 0055-1	UCECH 205-15	NACHI	OT 0070-1
UCC 205-16	FYH	OT 0016-1	UCC 209-26S	NSK	OT 0033-1	UCC 212-39	NACHI	OT 0055-1	UCECH 205-16	ASAHI	OT 0072-1
UCC 205-16S	NSK	OT 0016-1	UCC 209-27	SLB	OT 0034-1	UCC 213	SLB	OT 0057-1	UCECH 205-16	NACHI	OT 0072-1
UCC 206	SLB	OT 0019-1	UCC 209-27	ASAHI	OT 0034-1	UCC 213	ASAHI	OT 0057-1	UCECH 206	ASAHI	OT 0075-1
UCC 206	ASAHI	OT 0019-1	UCC 209-27	FYH	OT 0034-1	UCC 213	FYH	OT 0057-1	UCECH 206	NACHI	OT 0075-1
UCC 206	FYH	OT 0019-1	UCC 209-27	NACHI	OT 0034-1	UCC 213	NACHI	OT 0057-1	UCECH 206-17	ASAHI	OT 0073-1
UCC 206	NACHI	OT 0019-1	UCC 209-28	SLB	OT 0035-1	UCC 213	NSK	OT 0057-1	UCECH 206-17	NACHI	OT 0073-1
UCC 206	NSK	OT 0019-1	UCC 209-28	ASAHI	OT 0035-1	UCC 213-40	SLB	OT 0056-1	UCECH 206-18	ASAHI	OT 0074-1
UCC 206-17	SLB	OT 0017-1	UCC 209-28	FYH	OT 0035-1	UCC 213-40	ASAHI	OT 0056-1	UCECH 206-18	NACHI	OT 0074-1
UCC 206-17	ASAHI	OT 0017-1	UCC 209-28S	NSK	OT 0035-1	UCC 213-40	FYH	OT 0056-1	UCECH 206-19	ASAHI	OT 0076-1
UCC 206-17	NACHI	OT 0017-1	UCC 210	SLB	OT 0041-1	UCC 213-40	NACHI	OT 0056-1	UCECH 206-19	NACHI	OT 0076-1
UCC 206-18	SLB	OT 0018-1	UCC 210	ASAHI	OT 0041-1	UCC 213-40S	NSK	OT 0056-1	UCECH 207	ASAHI	OT 0081-1
UCC 206-18	ASAHI	OT 0018-1	UCC 210	FYH	OT 0041-1	UCC 213-41	SLB	OT 0058-1	UCECH 207	NACHI	OT 0081-1
UCC 206-18	FYH	OT 0018-1	UCC 210	NACHI	OT 0041-1	UCC201-008D1	NTN	OT 0002-1	UCECH 207-20	ASAHI	OT 0078-1
UCC 206-18	NACHI	OT 0018-1	UCC 210	NSK	OT 0041-1	UCC201D1	NTN	FU 0001-1	UCECH 207-20	NACHI	OT 0078-1
UCC 206-18S	NSK	OT 0018-1	UCC 210-29	SLB	OT 0038-1	UCC202-009D1	NTN	OT 0003-1	UCECH 207-21	ASAHI	OT 0079-1
UCC 206-19	SLB	OT 0021-1	UCC 210-30	SLB	OT 0039-1	UCC202-010D1	NTN	OT 0005-1	UCECH 207-21	NACHI	OT 0079-1
UCC 206-19	ASAHI	OT 0021-1	UCC 210-30	ASAHI	OT 0039-1	UCC202D1	NTN	OT 0004-1	UCECH 207-22	ASAHI	OT 0080-1
UCC 206-19	FYH	OT 0021-1	UCC 210-30	FYH	OT 0039-1	UCC 203-011D1	NTN	OT 0007-1	UCECH 207-22	NACHI	OT 0080-1
UCC 206-19	NACHI	OT 0021-1	UCC 210-30	NACHI	OT 0039-1	UCC203D1	NTN	OT 0006-1	UCECH 207-23	ASAHI	OT 0082-1
						UCC204-012D1	NTN	OT 0008-1	UCECH 207-23	NACHI	OT 0082-1

BY PART NUMBER

Part No.	Brand	Group No.	Part No.	Brand	Group No.	Part No.	Brand	Group No.	Part No.	Brand	Group No.
UCECH 208	ASAHI	OT 0085-1	UCHA 205	FYH	OT 0071-1	UCHA 213	SLB	OT 0106-1	UCST 204	ASAHI	OT 0128-1
UCECH 208	NACHI	OT 0085-1	UCHA 205-13	SLB	OT 0068-1	UCHA 213	FYH	OT 0106-1	UCST 204-12	SLB	OT 0125-1
UCECH 208-24	ASAHI	OT 0083-1	UCHA 205-14	SLB	OT 0069-1	UCHA 213-40	SLB	OT 0105-1	UCST 204-12	ASAHI	OT 0125-1
UCECH 208-24	NACHI	OT 0083-1	UCHA 205-14	FYH	OT 0069-1	UCHA 213-40	FYH	OT 0105-1	UCST 205	SLB	OT 0136-1
UCECH 208-25	ASAHI	OT 0084-1	UCHA 205-15	SLB	OT 0070-1	UCHA 213-41	SLB	OT 0107-1	UCST 205	ASAHI	OT 0136-1
UCECH 208-25	NACHI	OT 0084-1	UCHA 205-15	FYH	OT 0070-1	UCHA 213-41	FYH	OT 0107-1	UCST 205-13	SLB	OT 0130-1
UCECH 209	ASAHI	OT 0089-1	UCHA 205-16	SLB	OT 0072-1	UCHA 214	SLB	OT 0111-1	UCST 205-14	SLB	OT 0132-1
UCECH 209	NACHI	OT 0089-1	UCHA 205-16	FYH	OT 0072-1	UCHA 214	FYH	OT 0111-1	UCST 205-14	ASAHI	OT 0132-1
UCECH 209-26	ASAHI	OT 0086-1	UCHA 206	SLB	OT 0075-1	UCHA 214-42	SLB	OT 0108-1	UCST 205-15	SLB	OT 0134-1
UCECH 209-26	NACHI	OT 0086-1	UCHA 206	FYH	OT 0075-1	UCHA 214-42	FYH	OT 0108-1	UCST 205-15	ASAHI	OT 0134-1
UCECH 209-27	ASAHI	OT 0087-1	UCHA 206-17	SLB	OT 0073-1	UCHA 214-43	SLB	OT 0109-1	UCST 205-16	SLB	OT 0139-1
UCECH 209-27	NACHI	OT 0087-1	UCHA 206-18	SLB	OT 0074-1	UCHA 214-43	FYH	OT 0109-1	UCST 205-16	ASAHI	OT 0139-1
UCECH 209-28	ASAHI	OT 0088-1	UCHA 206-18	FYH	OT 0074-1	UCHA 214-44	SLB	OT 0110-1	UCST 206	SLB	OT 0146-1
UCECH 209-28	NACHI	OT 0088-1	UCHA 206-19	SLB	OT 0076-1	UCHA 214-44	FYH	OT 0110-1	UCST 206	ASAHI	OT 0146-1
UCECH 210	ASAHI	OT 0093-1	UCHA 206-19	FYH	OT 0076-1	UCHA 215	SLB	OT 0115-1	UCST 206-17	SLB	OT 0141-1
UCECH 210	NACHI	OT 0093-1	UCHA 206-20	SLB	OT 0077-1	UCHA 215	FYH	OT 0115-1	UCST 206-17	ASAHI	OT 0141-1
UCECH 210-30	ASAHI	OT 0091-1	UCHA 207	SLB	OT 0081-1	UCHA 215-45	SLB	OT 0112-1	UCST 206-18	SLB	OT 0143-1
UCECH 210-30	NACHI	OT 0091-1	UCHA 207	FYH	OT 0081-1	UCHA 215-45	FYH	OT 0112-1	UCST 206-18	ASAHI	OT 0143-1
UCECH 210-31	ASAHI	OT 0092-1	UCHA 207-20	SLB	OT 0078-1	UCHA 215-46	SLB	OT 0113-1	UCST 206-19	SLB	OT 0148-1
UCECH 210-31	NACHI	OT 0092-1	UCHA 207-20	FYH	OT 0078-1	UCHA 215-46	FYH	OT 0113-1	UCST 206-19	ASAHI	OT 0148-1
UCEH 201	NSK	OT 0059-1	UCHA 207-21	SLB	OT 0079-1	UCHA 215-47	SLB	OT 0114-1	UCST 206-20	SLB	OT 0151-1
UCEH 201-8S	NSK	OT 0060-1	UCHA 207-21	FYH	OT 0079-1	UCHA 215-48	SLB	OT 0116-1	UCST 207	SLB	OT 0158-1
UCEH 202	NSK	OT 0062-1	UCHA 207-22	SLB	OT 0080-1	UCHA 215-48	FYH	OT 0116-1	UCST 207	ASAHI	OT 0158-1
UCEH 202-10S	NSK	OT 0063-1	UCHA 207-22	FYH	OT 0080-1	UCHB201-008D1	NTN	OT 0060-1	UCST 207-20	SLB	OT 0152-1
UCEH 203	NSK	OT 0064-1	UCHA 207-23	SLB	OT 0082-1	UCHB201D1	NTN	OT 0059-1	UCST 207-20	ASAHI	OT 0152-1
UCEH 204	NSK	OT 0067-1	UCHA 207-23	FYH	OT 0082-1	UCHB202-009D1	NTN	OT 0061-1	UCST 207-21	SLB	OT 0154-1
UCEH 204-12S	NSK	OT 0066-1	UCHA 208	SLB	OT 0085-1	UCHB202-010D1	NTN	OT 0063-1	UCST 207-21	ASAHI	OT 0154-1
UCEH 205	NSK	OT 0071-1	UCHA 208	FYH	OT 0085-1	UCHB202D1	NTN	OT 0062-1	UCST 207-22	SLB	OT 0156-1
UCEH 205-14S	NSK	OT 0069-1	UCHA 208-24	SLB	OT 0083-1	UCHB203-011D1	NTN	OT 0065-1	UCST 207-22	ASAHI	OT 0156-1
UCEH 205-16S	NSK	OT 0072-1	UCHA 208-24	FYH	OT 0083-1	UCHB203D1	NTN	OT 0064-1	UCST 207-23	SLB	OT 0161-1
UCEH 206	NSK	OT 0075-1	UCHA 208-25	SLB	OT 0084-1	UCHB204-012D1	NTN	OT 0066-1	UCST 207-23	ASAHI	OT 0161-1
UCEH 206-18S	NSK	OT 0074-1	UCHA 208-25	FYH	OT 0084-1	UCHB204D1	NTN	OT 0067-1	UCST 208	SLB	OT 0166-1
UCEH 207	NSK	OT 0081-1	UCHA 209	SLB	OT 0089-1	UCHB205-013D1	NTN	OT 0068-1	UCST 208	ASAHI	OT 0166-1
UCEH 207-20S	NSK	OT 0078-1	UCHA 209	FYH	OT 0089-1	UCHB205-014D1	NTN	OT 0069-1	UCST 208-24	SLB	OT 0162-1
UCEH 207-22S	NSK	OT 0080-1	UCHA 209-26	SLB	OT 0086-1	UCHB205-015D1	NTN	OT 0070-1	UCST 208-24	ASAHI	OT 0162-1
UCEH 208	NSK	OT 0085-1	UCHA 209-26	FYH	OT 0086-1	UCHB205-100D1	NTN	OT 0072-1	UCST 208-25	SLB	OT 0164-1
UCEH 208-24S	NSK	OT 0083-1	UCHA 209-27	SLB	OT 0087-1	UCHB205D1	NTN	OT 0071-1	UCST 208-25	ASAHI	OT 0164-1
UCEH 209	NSK	OT 0089-1	UCHA 209-27	FYH	OT 0087-1	UCHB206-101D1	NTN	OT 0073-1	UCST 209	SLB	OT 0175-1
UCEH 209-26S	NSK	OT 0086-1	UCHA 209-28	SLB	OT 0088-1	UCHB206-102D1	NTN	OT 0074-1	UCST 209	ASAHI	OT 0175-1
UCEH 209-28S	NSK	OT 0088-1	UCHA 209-28	FYH	OT 0088-1	UCHB206-103D1	NTN	OT 0076-1	UCST 209-26	SLB	OT 0169-1
UCEH 210	NSK	OT 0093-1	UCHA 210	SLB	OT 0093-1	UCHB206-104D1	NTN	OT 0077-1	UCST 209-26	ASAHI	OT 0169-1
UCEH 210-30S	NSK	OT 0091-1	UCHA 210	FYH	OT 0093-1	UCHB206D1	NTN	OT 0075-1	UCST 209-27	SLB	OT 0171-1
UCEH 211	NSK	OT 0098-1	UCHA 210-29	SLB	OT 0090-1	UCHB207-104D1	NTN	OT 0078-1	UCST 209-27	ASAHI	OT 0171-1
UCEH 211-32S	NSK	OT 0095-1	UCHA 210-30	SLB	OT 0091-1	UCHB207-105D1	NTN	OT 0079-1	UCST 209-28	SLB	OT 0173-1
UCEH 211-34S	NSK	OT 0097-1	UCHA 210-30	FYH	OT 0091-1	UCHB207-106D1	NTN	OT 0080-1	UCST 209-28	ASAHI	OT 0173-1
UCEH 212	NSK	OT 0102-1	UCHA 210-31	SLB	OT 0092-1	UCHB207-107D1	NTN	OT 0082-1	UCST 210	SLB	OT 0184-1
UCEH 212-36S	NSK	OT 0100-1	UCHA 210-31	FYH	OT 0092-1	UCHB207D1	NTN	OT 0081-1	UCST 210	ASAHI	OT 0184-1
UCEH 212-38S	NSK	OT 0103-1	UCHA 210-32	SLB	OT 0094-1	UCHB208-108D1	NTN	OT 0083-1	UCST 210-29	SLB	OT 0178-1
UCEH 213	NSK	OT 0106-1	UCHA 211	SLB	OT 0098-1	UCHB208-109D1	NTN	OT 0084-1	UCST 210-30	SLB	OT 0180-1
UCEH 213-40S	NSK	OT 0105-1	UCHA 211	FYH	OT 0098-1	UCHB208D1	NTN	OT 0085-1	UCST 210-30	ASAHI	OT 0180-1
UCHA 201	SLB	OT 0059-1	UCHA 211-32	SLB	OT 0095-1	UCHB209-110D1	NTN	OT 0086-1	UCST 210-31	SLB	OT 0182-1
UCHA 201	FYH	OT 0059-1	UCHA 211-32	FYH	OT 0095-1	UCHB209-111D1	NTN	OT 0087-1	UCST 210-31	ASAHI	OT 0182-1
UCHA 201-8	SLB	OT 0060-1	UCHA 211-33	SLB	OT 0096-1	UCHB209-112D1	NTN	OT 0088-1	UCST 210-32	SLB	OT 0187-1
UCHA 201-8	FYH	OT 0060-1	UCHA 211-33	FYH	OT 0096-1	UCHB209D1	NTN	OT 0089-1	UCST 211	SLB	OT 0197-1
UCHA 202	SLB	OT 0062-1	UCHA 211-34	SLB	OT 0097-1	UCHB210-113D1	NTN	OT 0090-1	UCST 211	ASAHI	OT 0197-1
UCHA 202	FYH	OT 0062-1	UCHA 211-34	FYH	OT 0097-1	UCHB210-114D1	NTN	OT 0091-1	UCST 211-32	SLB	OT 0190-1
UCHA 202-10	SLB	OT 0063-1	UCHA 211-35	SLB	OT 0099-1	UCHB210-115D1	NTN	OT 0092-1	UCST 211-32	ASAHI	OT 0190-1
UCHA 202-10	FYH	OT 0063-1	UCHA 211-35	FYH	OT 0099-1	UCHB210-200D1	NTN	OT 0094-1	UCST 211-33	SLB	OT 0192-1
UCHA 202-9	SLB	OT 0061-1	UCHA 212	SLB	OT 0102-1	UCHB210D1	NTN	OT 0093-1	UCST 211-33	ASAHI	OT 0192-1
UCHA 203	SLB	OT 0064-1	UCHA 212	FYH	OT 0102-1	UCHB212-204D1	NTN	OT 0100-1	UCST 211-34	SLB	OT 0194-1
UCHA 203	FYH	OT 0064-1	UCHA 212-36	SLB	OT 0100-1	UCHB212-205D1	NTN	OT 0101-1	UCST 211-34	ASAHI	OT 0194-1
UCHA 203-11	SLB	OT 0065-1	UCHA 212-36	FYH	OT 0100-1	UCHB212-206D1	NTN	OT 0103-1	UCST 211-35	SLB	OT 0199-1
UCHA 204	SLB	OT 0067-1	UCHA 212-37	SLB	OT 0101-1	UCHB212-207D1	NTN	OT 0104-1	UCST 211-35	ASAHI	OT 0199-1
UCHA 204	FYH	OT 0067-1	UCHA 212-38	SLB	OT 0103-1	UCHB212D1	NTN	OT 0102-1	UCST 212	SLB	OT 0205-1
UCHA 204-12	SLB	OT 0066-1	UCHA 212-38	FYH	OT 0103-1	UCHB213-208D1	NTN	OT 0105-1	UCST 212	ASAHI	OT 0205-1
UCHA 204-12	FYH	OT 0066-1	UCHA 212-39	SLB	OT 0104-1	UCHB213D1	NTN	OT 0106-1	UCST 212-36	SLB	OT 0201-1
UCHA 205	SLB	OT 0071-1	UCHA 212-39	FYH	OT 0104-1	UCST 204	SLB	OT 0128-1	UCST 212-36	ASAHI	OT 0201-1

BY PART NUMBER

BY PART NUMBER

Part No.	Brand	Group No.	Part No.	Brand	Group No.	Part No.	Brand	Group No.	Part No.	Brand	Group No.
UCST 212-37	SLB	OT 0203-1	UCT 205	SLB	OT 0135-1	UCT 207-22S	NSK	OT 0155-1	UCT 211	ASAHI	OT 0195-1
UCST 212-37	FYH	OT 0203-1	UCT 205	ASAHI	OT 0135-1	UCT 207-23	KOYO	OT 0160-1	UCT 211	FYH	OT 0195-1
UCST 212-38	SLB	OT 0208-1	UCT 205	FYH	OT 0135-1	UCT 207-23	SLB	OT 0160-1	UCT 211	NACHI	OT 0195-1
UCST 212-38	ASAHI	OT 0208-1	UCT 205	NACHI	OT 0135-1	UCT 207-23	ASAHI	OT 0160-1	UCT 211	NSK	OT 0195-1
UCST 212-39	SLB	OT 0210-1	UCT 205	NSK	OT 0135-1	UCT 207-23	FYH	OT 0160-1	UCT 211-32	KOYO	OT 0189-1
UCST 212-39	ASAHI	OT 0210-1	UCT 205-13	KOYO	OT 0129-1	UCT 207-23	NACHI	OT 0160-1	UCT 211-32	SLB	OT 0189-1
UCST 213	SLB	OT 0214-1	UCT 205-13	SLB	OT 0129-1	UCT 208	KOYO	OT 0167-1	UCT 211-32	ASAHI	OT 0189-1
UCST 213	ASAHI	OT 0214-1	UCT 205-14	KOYO	OT 0131-1	UCT 208	SLB	OT 0167-1	UCT 211-32	FYH	OT 0189-1
UCST 213-40	SLB	OT 0212-1	UCT 205-14	SLB	OT 0131-1	UCT 208	ASAHI	OT 0167-1	UCT 211-32	NACHI	OT 0189-1
UCST 213-40	ASAHI	OT 0212-1	UCT 205-14	ASAHI	OT 0131-1	UCT 208	FYH	OT 0167-1	UCT 211-32S	NSK	OT 0189-1
UCST 213-41	SLB	OT 0216-1	UCT 205-14	FYH	OT 0131-1	UCT 208	NACHI	OT 0167-1	UCT 211-33	SLB	OT 0191-1
UCST 213-41	FYH	OT 0216-1	UCT 205-14	NACHI	OT 0131-1	UCT 208	NSK	OT 0167-1	UCT 211-33	ASAHI	OT 0191-1
UCST 214	SLB	OT 0224-1	UCT 205-14S	NSK	OT 0131-1	UCT 208-24	KOYO	OT 0163-1	UCT 211-33	NACHI	OT 0191-1
UCST 214-42	SLB	OT 0218-1	UCT 205-15	KOYO	OT 0133-1	UCT 208-24	SLB	OT 0163-1	UCT 211-34	SLB	OT 0193-1
UCST 214-42	FYH	OT 0218-1	UCT 205-15	SLB	OT 0133-1	UCT 208-24	ASAHI	OT 0163-1	UCT 211-34	ASAHI	OT 0193-1
UCST 214-43	SLB	OT 0220-1	UCT 205-15	ASAHI	OT 0133-1	UCT 208-24	FYH	OT 0163-1	UCT 211-34	FYH	OT 0193-1
UCST 214-44	SLB	OT 0222-1	UCT 205-15	FYH	OT 0133-1	UCT 208-24	NACHI	OT 0163-1	UCT 211-34	NACHI	OT 0193-1
UCST 215	SLB	OT 0232-1	UCT 205-15	NACHI	OT 0133-1	UCT 208-24S	NSK	OT 0163-1	UCT 211-34S	NSK	OT 0193-1
UCST 215-45	SLB	OT 0226-1	UCT 205-16	KOYO	OT 0138-1	UCT 208-25	KOYO	OT 0165-1	UCT 211-35	KOYO	OT 0198-1
UCST 215-45	FYH	OT 0226-1	UCT 205-16	SLB	OT 0138-1	UCT 208-25	SLB	OT 0165-1	UCT 211-35	SLB	OT 0198-1
UCST 215-46	SLB	OT 0228-1	UCT 205-16	ASAHI	OT 0138-1	UCT 208-25	ASAHI	OT 0165-1	UCT 211-35	ASAHI	OT 0198-1
UCST 215-47	SLB	OT 0230-1	UCT 205-16	FYH	OT 0138-1	UCT 208-25	FYH	OT 0165-1	UCT 211-35	FYH	OT 0198-1
UCST 215-48	SLB	OT 0234-1	UCT 205-16	NACHI	OT 0138-1	UCT 208-25	NACHI	OT 0165-1	UCT 211-35	NACHI	OT 0198-1
UCT 201	SLB	OT 0117-1	UCT 205-16S	NSK	OT 0138-1	UCT 209	KOYO	OT 0176-1	UCT 212	SLB	OT 0204-1
UCT 201	ASAHI	OT 0117-1	UCT 206	KOYO	OT 0144-1	UCT 209	SLB	OT 0176-1	UCT 212	ASAHI	OT 0204-1
UCT 201	FYH	OT 0117-1	UCT 206	SLB	OT 0144-1	UCT 209	ASAHI	OT 0176-1	UCT 212	FYH	OT 0204-1
UCT 201	NACHI	OT 0117-1	UCT 206	ASAHI	OT 0144-1	UCT 209	FYH	OT 0176-1	UCT 212	NACHI	OT 0204-1
UCT 201	NSK	OT 0117-1	UCT 206	FYH	OT 0144-1	UCT 209	NACHI	OT 0176-1	UCT 212	NSK	OT 0204-1
UCT 201-8	SLB	OT 0118-1	UCT 206	NACHI	OT 0144-1	UCT 209	NSK	OT 0176-1	UCT 212-36	SLB	OT 0200-1
UCT 201-8	ASAHI	OT 0118-1	UCT 206	NSK	OT 0144-1	UCT 209-26	KOYO	OT 0170-1	UCT 212-36	ASAHI	OT 0200-1
UCT 201-8	FYH	OT 0118-1	UCT 206-17	SLB	OT 0140-1	UCT 209-26	SLB	OT 0170-1	UCT 212-36	FYH	OT 0200-1
UCT 201-8	NACHI	OT 0118-1	UCT 206-17	ASAHI	OT 0140-1	UCT 209-26	ASAHI	OT 0170-1	UCT 212-36	NACHI	OT 0200-1
UCT 201-8S	NSK	OT 0118-1	UCT 206-17	NACHI	OT 0140-1	UCT 209-26	FYH	OT 0170-1	UCT 212-36S	NSK	OT 0200-1
UCT 202	SLB	OT 0120-1	UCT 206-18	KOYO	OT 0142-1	UCT 209-26	NACHI	OT 0170-1	UCT 212-37	SLB	OT 0202-1
UCT 202	ASAHI	OT 0120-1	UCT 206-18	SLB	OT 0142-1	UCT 209-26S	NSK	OT 0170-1	UCT 212-38	SLB	OT 0207-1
UCT 202	FYH	OT 0120-1	UCT 206-18	ASAHI	OT 0142-1	UCT 209-27	KOYO	OT 0172-1	UCT 212-38	ASAHI	OT 0207-1
UCT 202	NACHI	OT 0120-1	UCT 206-18	FYH	OT 0142-1	UCT 209-27	SLB	OT 0172-1	UCT 212-38	FYH	OT 0207-1
UCT 202	NSK	OT 0120-1	UCT 206-18	NACHI	OT 0142-1	UCT 209-27	ASAHI	OT 0172-1	UCT 212-38	NACHI	OT 0207-1
UCT 202-10	SLB	OT 0121-1	UCT 206-18S	NSK	OT 0142-1	UCT 209-27	FYH	OT 0172-1	UCT 212-38S	NSK	OT 0207-1
UCT 202-10	ASAHI	OT 0121-1	UCT 206-19	KOYO	OT 0147-1	UCT 209-27	NACHI	OT 0172-1	UCT 212-39	SLB	OT 0209-1
UCT 202-10	FYH	OT 0121-1	UCT 206-19	SLB	OT 0147-1	UCT 209-28	KOYO	OT 0174-1	UCT 212-39	ASAHI	OT 0209-1
UCT 202-10	NACHI	OT 0121-1	UCT 206-19	ASAHI	OT 0147-1	UCT 209-28	SLB	OT 0174-1	UCT 212-39	FYH	OT 0209-1
UCT 202-10S	NSK	OT 0121-1	UCT 206-19	FYH	OT 0147-1	UCT 209-28	ASAHI	OT 0174-1	UCT 212-39	NACHI	OT 0209-1
UCT 202-9	SLB	OT 0119-1	UCT 206-19	NACHI	OT 0147-1	UCT 209-28	FYH	OT 0174-1	UCT 213	SLB	OT 0213-1
UCT 202-9	ASAHI	OT 0119-1	UCT 206-20	SLB	OT 0149-1	UCT 209-28	NACHI	OT 0174-1	UCT 213	ASAHI	OT 0213-1
UCT 202-9	NACHI	OT 0119-1	UCT 207	KOYO	OT 0157-1	UCT 209-28S	NSK	OT 0174-1	UCT 213	FYH	OT 0213-1
UCT 203	SLB	OT 0122-1	UCT 207	SLB	OT 0157-1	UCT 210	KOYO	OT 0185-1	UCT 213	NACHI	OT 0213-1
UCT 203	ASAHI	OT 0122-1	UCT 207	ASAHI	OT 0157-1	UCT 210	SLB	OT 0185-1	UCT 213	NSK	OT 0213-1
UCT 203	FYH	OT 0122-1	UCT 207	FYH	OT 0157-1	UCT 210	ASAHI	OT 0185-1	UCT 213-40	SLB	OT 0211-1
UCT 203	NACHI	OT 0122-1	UCT 207	NACHI	OT 0157-1	UCT 210	FYH	OT 0185-1	UCT 213-40	ASAHI	OT 0211-1
UCT 203	NSK	OT 0122-1	UCT 207	NSK	OT 0157-1	UCT 210	NACHI	OT 0185-1	UCT 213-40	FYH	OT 0211-1
UCT 203-11	SLB	OT 0123-1	UCT 207-20	KOYO	OT 0150-1	UCT 210	NSK	OT 0185-1	UCT 213-40	NACHI	OT 0211-1
UCT 203-11	ASAHI	OT 0123-1	UCT 207-20	SLB	OT 0150-1	UCT 210-29	SLB	OT 0179-1	UCT 213-40S	NSK	OT 0211-1
UCT 203-11	NACHI	OT 0123-1	UCT 207-20	ASAHI	OT 0150-1	UCT 210-30	KOYO	OT 0181-1	UCT 213-41	SLB	OT 0215-1
UCT 204	KOYO	OT 0126-1	UCT 207-20	FYH	OT 0150-1	UCT 210-30	SLB	OT 0181-1	UCT 214	SLB	OT 0223-1
UCT 204	SLB	OT 0126-1	UCT 207-20	NACHI	OT 0150-1	UCT 210-30	ASAHI	OT 0181-1	UCT 214	ASAHI	OT 0223-1
UCT 204	ASAHI	OT 0126-1	UCT 207-20S	NSK	OT 0150-1	UCT 210-30	FYH	OT 0181-1	UCT 214	FYH	OT 0223-1
UCT 204	FYH	OT 0126-1	UCT 207-21	KOYO	OT 0153-1	UCT 210-30	NACHI	OT 0181-1	UCT 214	NACHI	OT 0223-1
UCT 204	NACHI	OT 0126-1	UCT 207-21	SLB	OT 0153-1	UCT 210-30S	NSK	OT 0181-1	UCT 214	NSK	OT 0223-1
UCT 204	NSK	OT 0126-1	UCT 207-21	ASAHI	OT 0153-1	UCT 210-31	KOYO	OT 0183-1	UCT 214-42	SLB	OT 0217-1
UCT 204-12	KOYO	OT 0124-1	UCT 207-21	FYH	OT 0153-1	UCT 210-31	SLB	OT 0183-1	UCT 214-43	SLB	OT 0219-1
UCT 204-12	SLB	OT 0124-1	UCT 207-21	NACHI	OT 0153-1	UCT 210-31	ASAHI	OT 0183-1	UCT 214-44	SLB	OT 0221-1
UCT 204-12	ASAHI	OT 0124-1	UCT 207-22	KOYO	OT 0155-1	UCT 210-31	FYH	OT 0183-1	UCT 214-44	ASAHI	OT 0221-1
UCT 204-12	FYH	OT 0124-1	UCT 207-22	SLB	OT 0155-1	UCT 210-31	NACHI	OT 0183-1	UCT 214-44	FYH	OT 0221-1
UCT 204-12	NACHI	OT 0124-1	UCT 207-22	ASAHI	OT 0155-1	UCT 210-32	SLB	OT 0188-1	UCT 214-44	NACHI	OT 0221-1
UCT 204-12S	NSK	OT 0124-1	UCT 207-22	FYH	OT 0155-1	UCT 211	KOYO	OT 0195-1	UCT 214-44S	NSK	OT 0221-1
UCT 205	KOYO	OT 0135-1	UCT 207-22	NACHI	OT 0155-1	UCT 211	SLB	OT 0195-1	UCT 215	SLB	OT 0231-1

BY PART NUMBER

Part No.	Brand	Group No.	Part No.	Brand	Group No.	Part No.	Brand	Group No.
UKC 209	NSK	OT 0031-1	UKT210D1	NTN	OT 0177-1	VTWS-235	BROWNING	OT 0199-1
UKC 210	SLB	OT 0037-1	UKT211D1	NTN	OT 0186-1	VTWS-239	BROWNING	OT 0210-1
UKC 210	FYH	OT 0037-1	UKT212D1	NTN	OT 0196-1	YYU-1	FAFNIR	OT 0139-3
UKC 210	NACHI	OT 0037-1	UKT213D1	NTN	OT 0206-1			
UKC 210	NSK	OT 0037-1	VTU-1-1/16	FAFNIR	OT 0141-3			
UKC 211	SLB	OT 0042-1	VTU-1-1/2	FAFNIR	OT 0162-3			
UKC 211	FYH	OT 0042-1	VTU-1-1/4	FAFNIR	OT 0152-3			
UKC 211	NACHI	OT 0042-1	VTU-1-1/8	FAFNIR	OT 0143-3			
UKC 211	NSK	OT 0042-1	VTU-1-11/16	FAFNIR	OT 0171-3			
UKC 212	SLB	OT 0048-1	VTU-1-13/16	FAFNIR	OT 0178-3			
UKC 212	FYH	OT 0048-1	VTU-1-15/16	FAFNIR	OT 0182-3			
UKC 212	NACHI	OT 0048-1	VTU-13/16	FAFNIR	OT 0130-3			
UKC 212	NSK	OT 0048-1	VTU-1-3/16	FAFNIR	OT 0148-3			
UKC 213	SLB	OT 0053-1	VTU-1-3/4	FAFNIR	OT 0173-3			
UKC 213	FYH	OT 0053-1	VTU-1-3/8	FAFNIR	OT 0156-3			
UKC 213	NACHI	OT 0053-1	VTU-15/16	FAFNIR	OT 0134-3			
UKC 213	NSK	OT 0053-1	VTU-1-5/16	FAFNIR	OT 0154-3			
UKC205D1	NTN	OT 0010-1	VTU-1-5/8	FAFNIR	OT 0169-3			
UKC206D1	NTN	OT 0015-1	VTU-1-7/16	FAFNIR	OT 0161-3			
UKC207D1	NTN	OT 0020-1	VTU-1-7/8	FAFNIR	OT 0180-3			
UKC208D1	NTN	OT 0027-1	VTU-1-9/16	FAFNIR	OT 0164-3			
UKC209D1	NTN	OT 0031-1	VTU-2	FAFNIR	OT 0190-3			
UKC210D1	NTN	OT 0037-1	VTU-20	FAFNIR	OT 0128-3			
UKC211D1	NTN	OT 0042-1	VTU-2-1/16	FAFNIR	OT 0192-3			
UKC212D1	NTN	OT 0048-1	VTU-2-1/8	FAFNIR	OT 0194-3			
UKC213D1	NTN	OT 0053-1	VTU-2-3/16	FAFNIR	OT 0199-3			
UKT 205	SLB	OT 0127-1	VTU-25	FAFNIR	OT 0136-3			
UKT 205	FYH	OT 0127-1	VTU-3/4	FAFNIR	OT 0125-3			
UKT 205	NACHI	OT 0127-1	VTU-30	FAFNIR	OT 0146-3			
UKT 205	NSK	OT 0127-1	VTU-35	FAFNIR	OT 0158-3			
UKT 206	SLB	OT 0137-1	VTU-40	FAFNIR	OT 0166-3			
UKT 206	FYH	OT 0137-1	VTU-45	FAFNIR	OT 0175-3			
UKT 206	NACHI	OT 0137-1	VTU-50	FAFNIR	OT 0184-3			
UKT 206	NSK	OT 0137-1	VTU-55	FAFNIR	OT 0197-3			
UKT 207	SLB	OT 0145-1	VTU-7/8	FAFNIR	OT 0132-3			
UKT 207	FYH	OT 0145-1	VTWE-212	BROWNING	OT 0125-2			
UKT 207	NACHI	OT 0145-1	VTWE-214	BROWNING	OT 0132-2			
UKT 207	NSK	OT 0145-1	VTWE-215	BROWNING	OT 0134-2			
UKT 208	SLB	OT 0159-1	VTWE-216	BROWNING	OT 0139-2			
UKT 208	FYH	OT 0159-1	VTWE-218	BROWNING	OT 0143-2			
UKT 208	NACHI	OT 0159-1	VTWE-219	BROWNING	OT 0148-2			
UKT 208	NSK	OT 0159-1	VTWE-220	BROWNING	OT 0151-2			
UKT 209	SLB	OT 0168-1	VTWE-222	BROWNING	OT 0156-2			
UKT 209	FYH	OT 0168-1	VTWE-223	BROWNING	OT 0161-2			
UKT 209	NACHI	OT 0168-1	VTWE-224	BROWNING	OT 0162-2			
UKT 209	NSK	OT 0168-1	VTWE-226	BROWNING	OT 0169-2			
UKT 210	SLB	OT 0177-1	VTWE-227	BROWNING	OT 0171-2			
UKT 210	FYH	OT 0177-1	VTWE-228	BROWNING	OT 0173-2			
UKT 210	NACHI	OT 0177-1	VTWE-231	BROWNING	OT 0182-2			
UKT 210	NSK	OT 0177-1	VTWE-232	BROWNING	OT 0190-2			
UKT 211	SLB	OT 0186-1	VTWE-235	BROWNING	OT 0199-2			
UKT 211	FYH	OT 0186-1	VTWE-239	BROWNING	OT 0210-2			
UKT 211	NACHI	OT 0186-1	VTWS-212	BROWNING	OT 0125-1			
UKT 211	NSK	OT 0186-1	VTWS-214	BROWNING	OT 0132-1			
UKT 212	SLB	OT 0196-1	VTWS-215	BROWNING	OT 0134-1			
UKT 212	FYH	OT 0196-1	VTWS-216	BROWNING	OT 0139-1			
UKT 212	NACHI	OT 0196-1	VTWS-218	BROWNING	OT 0143-1			
UKT 212	NSK	OT 0196-1	VTWS-219	BROWNING	OT 0148-1			
UKT 213	SLB	OT 0206-1	VTWS-220	BROWNING	OT 0151-1			
UKT 213	FYH	OT 0206-1	VTWS-222	BROWNING	OT 0156-1			
UKT 213	NACHI	OT 0206-1	VTWS-223	BROWNING	OT 0161-1			
UKT 213	NSK	OT 0206-1	VTWS-224	BROWNING	OT 0162-1			
UKT205D1	NTN	OT 0127-1	VTWS-226	BROWNING	OT 0169-1			
UKT206D1	NTN	OT 0137-1	VTWS-227	BROWNING	OT 0171-1			
UKT207D1	NTN	OT 0145-1	VTWS-228	BROWNING	OT 0173-1			
UKT208D1	NTN	OT 0159-1	VTWS-231	BROWNING	OT 0182-1			
UKT209D1	NTN	OT 0168-1	VTWS-232	BROWNING	OT 0190-1			

BY PART NUMBER

Part No.	Brand	Group No.	Part No.	Brand	Group No.	Part No.	Brand	Group No.	Part No.	Brand	Group No.
1020-20DECG	RHP	IB 0036-1	1055-50KG	RHP	IB 0189-1	1230-1 1/4ECG	RHP	IB 0096-1	2-16	SEALMASTER	IB 0113-1
1020-20G	RHP	IB 0034-1	1055-55DECG	RHP	IB 0214-1	1230-1 1/4G	RHP	IB 0094-1	2-17	SEALMASTER	IB 0126-1
1020-20G	SNR	IB 0034-1	1055-55G	RHP	IB 0212-1	1230-1 1/8ECG	RHP	IB 0077-1	2-18	SEALMASTER	IB 0132-1
1020-3/4DECG	RHP	IB 0032-1	1055-55G	SNR	IB 0212-1	1230-1 3/16ECG	RHP	IB 0090-1	2-19	SEALMASTER	IB 0138-1
1020-3/4G	RHP	IB 0030-1	1060-2 1/4DECG	RHP	IB 0224-1	1230-30ECG	RHP	IB 0083-1	2-2	SEALMASTER	IB 0197-1
1025-15/16DECG	RHP	IB 0053-1	1060-2 1/4G	RHP	IB 0223-1	1230-30ECG	SNR	IB 0083-1	2-214	SEALMASTER	IB 0276-1
1025-15/16G	RHP	IB 0051-1	1060-2 3/8DECG	RHP	IB 0237-1	1230-30G	RHP	IB 0081-1	2-215	SEALMASTER	IB 0280-1
1025-1DECG	RHP	IB 0066-1	1060-2 3/8G	RHP	IB 0236-1	1230-30G	SNR	IB 0081-1	2-22	SEALMASTER	IB 0207-1
1025-1G	RHP	IB 0064-1	1060-2 7/16DECG	RHP	IB 0241-1	1235-1 1/4ECG	RHP	IB 0102-1	2-23	SEALMASTER	IB 0218-1
1025-20KG	RHP	IB 0037-1	1060-2 7/16G	RHP	IB 0240-1	1235-1 1/4G	RHP	IB 0100-1	2-24	SEALMASTER	IB 0223-1
1025-25DECG	RHP	IB 0059-1	1060-60DECG	RHP	IB 0232-1	1235-1 3/8ECG	RHP	IB 0114-1	2-26	SEALMASTER	IB 0236-1
1025-25G	RHP	IB 0057-1	1060-60G	RHP	IB 0231-1	1235-1 7/16ECG	RHP	IB 0127-1	2-27	SEALMASTER	IB 0240-1
1025-25G	SNR	IB 0057-1	1060-60G	SNR	IB 0231-1	1235-35ECG	RHP	IB 0120-1	2-33	SEALMASTER	IB 0301-1
1025-7/8DECG	RHP	IB 0047-1	1065-2 1/2DECG	RHP	IB 0245-1	1235-35ECG	SNR	IB 0120-1	2-34	SEALMASTER	IB 0302-1
1025-7/8G	RHP	IB 0045-1	1065-2 1/2G	RHP	IB 0244-1	1235-35G	RHP	IB 0118-1	2-37	SEALMASTER	IB 0305-1
1030-1 1/4DECG	RHP	IB 0097-1	1065-65G	RHP	IB 0248-1	1235-35G	SNR	IB 0118-1	2-38	SEALMASTER	IB 0306-1
1030-1 1/4G	RHP	IB 0095-1	1070-2 11/16DECG	RHP	IB 0261-1	1240-40ECG	SNR	IB 0145-1	3-015	SEALMASTER	IB 0054-1
1030-1 1/8DECG	RHP	IB 0078-1	1070-2 11/16G	RHP	IB 0260-1	1240-40G	SNR	IB 0143-1	3-1	SEALMASTER	IB 0067-1
1030-1 1/8G	RHP	IB 0076-1	1070-2 5/8DECG	RHP	IB 0257-1	1245-1 11/16ECG	RHP	IB 0156-1	3-111	SEALMASTER	IB 0158-1
1030-1 3/16DECG	RHP	IB 0091-1	1070-2 5/8G	RHP	IB 0256-1	1245-1 3/4ECG	RHP	IB 0161-1	3-112	SEALMASTER	IB 0163-1
1030-1 3/16G	RHP	IB 0089-1	1070-70DECG	RHP	IB 0269-1	1245-1 5/8ECG	RHP	IB 0151-1	3-115	SEALMASTER	IB 0184-1
1030-25KG	RHP	IB 0060-1	1070-70G	RHP	IB 0268-1	1245-45ECG	RHP	IB 0166-1	3-13	SEALMASTER	IB 0092-1
1030-30DECG	RHP	IB 0084-1	1070-70G	SNR	IB 0268-1	1245-45ECG	SNR	IB 0166-1	3-17	SEALMASTER	IB 0129-1
1030-30G	RHP	IB 0082-1	1075-2 15/16DECG	RHP	IB 0281-1	1250-1 15/16ECG	RHP	IB 0182-1	3-18	SEALMASTER	IB 0135-1
1030-30G	SNR	IB 0082-1	1075-2 15/16G	RHP	IB 0280-1	1250-1 7/8ECG	RHP	IB 0177-1	3-211	SEALMASTER	IB 0262-1
1035-1 1/4DECG	RHP	IB 0103-1	1075-2 7/8DECG	RHP	IB 0277-1	1250-2ECG	RHP	IB 0193-1	3-215	SEALMASTER	IB 0282-1
1035-1 1/4G	RHP	IB 0101-1	1075-2 7/8G	RHP	IB 0276-1	1250-50ECG	RHP	IB 0187-1	3-23	SEALMASTER	IB 0221-1
1035-1 3/8DECG	RHP	IB 0115-1	1075-3G	RHP	IB 0288-1	1250-50ECG	SNR	IB 0187-1	3-27	SEALMASTER	IB 0242-1
1035-1 3/8G	RHP	IB 0113-1	1075-75DECG	RHP	IB 0285-1	16203	FAG	IB 0023-1	3-3	SEALMASTER	IB 0290-1
1035-1 5/16G	RHP	IB 0107-1	1075-75G	RHP	IB 0284-1	16203/15	FAG	IB 0015-1	36204B	FAG	IB 0036-1
1035-1 7/16DECG	RHP	IB 0128-1	1075-75G	SNR	IB 0284-1	16204	FAG	IB 0035-1	36205B	FAG	IB 0059-1
1035-1 7/16G	RHP	IB 0126-1	1080-3 1/4G	RHP	IB 0302-1	16204.012	FAG	IB 0031-1	36206B	FAG	IB 0084-1
1035-30KG	RHP	IB 0085-1	1080-3 1/4G	SNR	IB 0302-1	16205	FAG	IB 0058-1	36207B	FAG	IB 0121-1
1035-35DECG	RHP	IB 0121-1	1080-3 3/16G	RHP	IB 0301-1	16205.014	FAG	IB 0046-1	36208B	FAG	IB 0146-1
1035-35G	RHP	IB 0119-1	1080-3 3/16G	SNR	IB 0301-1	16205.100	FAG	IB 0065-1	36209B	FAG	IB 0167-1
1035-35G	SNR	IB 0119-1	1080-80G	RHP	IB 0298-1	16206	FAG	IB 0083-1	36210B	FAG	IB 0188-1
1040-1 1/2DECG	RHP	IB 0134-1	1080-80G	SNR	IB 0298-1	16206.101	FAG	IB 0071-1	5204	SEALMASTER	IB 0034-1
1040-1 1/2G	RHP	IB 0132-1	1085-3 7/16G	RHP	IB 0305-1	16206.102	FAG	IB 0077-1	5205	SEALMASTER	IB 0057-1
1040-35KG	RHP	IB 0122-1	1085-3 7/16G	SNR	IB 0305-1	16206.103	FAG	IB 0090-1	5206	SEALMASTER	IB 0082-1
1040-40DECG	RHP	IB 0146-1	1085-85G	RHP	IB 0304-1	16206.104	FAG	IB 0096-1	5207	SEALMASTER	IB 0119-1
1040-40G	RHP	IB 0144-1	1085-85G	SNR	IB 0304-1	16207	FAG	IB 0120-1	5208	SEALMASTER	IB 0144-1
1040-40G	SNR	IB 0144-1	1090-3 1/2G	RHP	IB 0306-1	16207.106	FAG	IB 0114-1	5209	SEALMASTER	IB 0165-1
1045-1 11/16DECG	RHP	IB 0157-1	1090-3 1/2G	SNR	IB 0306-1	16208	FAG	IB 0145-1	5210	SEALMASTER	IB 0186-1
1045-1 11/16G	RHP	IB 0155-1	1090-90G	RHP	IB 0307-1	16208.108	FAG	IB 0133-1	5211	SEALMASTER	IB 0122-1
1045-1 3/4DECG	RHP	IB 0162-1	1090-90G	SNR	IB 0307-1	16209	FAG	IB 0166-1	5212	SEALMASTER	IB 0231-1
1045-1 3/4G	RHP	IB 0160-1	1-14	SEALMASTER	IB 0095-1	16209.112	FAG	IB 0161-1	5215	SEALMASTER	IB 0284-1
1045-1 5/8DECG	RHP	IB 0152-1	1-2	SEALMASTER	IB 0192-1	16210	FAG	IB 0187-1	5216	SEALMASTER	IB 0298-1
1045-1 5/8G	RHP	IB 0150-1	1217-1/2ECG	RHP	IB 0007-1	2-010	SEALMASTER	IB 0018-1	5218	SEALMASTER	IB 0307-1
1045-40KG	RHP	IB 0147-1	1217-12ECG	RHP	IB 0003-1	2-011	SEALMASTER	IB 0026-1	5305	SEALMASTER	IB 0061-1
1045-45DECG	RHP	IB 0167-1	1217-15ECG	RHP	IB 0015-1	2-012	SEALMASTER	IB 0030-1	5306	SEALMASTER	IB 0086-1
1045-45G	RHP	IB 0165-1	1217-17ECG	RHP	IB 0023-1	2-013	SEALMASTER	IB 0039-1	5307	SEALMASTER	IB 0123-1
1045-45G	SNR	IB 0165-1	1217-17ECG	SNR	IB 0023-1	2-014	SEALMASTER	IB 0045-1	5308	SEALMASTER	IB 0148-1
1050-1 15/16DECG	RHP	IB 0183-1	1217-5/8ECG	RHP	IB 0019-1	2-015	SEALMASTER	IB 0051-1	5309	SEALMASTER	IB 0169-1
1050-1 15/16G	RHP	IB 0181-1	1220-20ECG	RHP	IB 0035-1	2-08	SEALMASTER	IB 0006-1	5310	SEALMASTER	IB 0190-1
1050-1 7/8DECG	RHP	IB 0178-1	1220-20ECG	SNR	IB 0035-1	2-09	SEALMASTER	IB 0010-1	5311	SEALMASTER	IB 0216-1
1050-1 7/8G	RHP	IB 0176-1	1220-20G	RHP	IB 0033-1	2-1	SEALMASTER	IB 0064-1	5314	SEALMASTER	IB 0270-1
1050-2G	RHP	IB 0192-1	1220-20G	SNR	IB 0033-1	2-11	SEALMASTER	IB 0070-1	5315	SEALMASTER	IB 0286-1
1050-45KG	RHP	IB 0168-1	1220-3/4ECG	RHP	IB 0031-1	2-110	SEALMASTER	IB 0150-1	5316	SEALMASTER	IB 0299-1
1050-50DECG	RHP	IB 0188-1	1220-3/4G	RHP	IB 0029-1	2-111	SEALMASTER	IB 0155-1	56204	FAG	IB 0034-1
1050-50G	RHP	IB 0186-1	1225-15/16ECG	RHP	IB 0052-1	2-112	SEALMASTER	IB 0160-1	56204.012	FAG	IB 0030-1
1050-50G	SNR	IB 0186-1	1225-1ECG	RHP	IB 0065-1	2-113	SEALMASTER	IB 0171-1	56205	FAG	IB 0057-1
1055-2 1/8DECG	RHP	IB 0209-1	1225-1G	RHP	IB 0063-1	2-114	SEALMASTER	IB 0176-1	56205.100	FAG	IB 0064-1
1055-2 1/8G	RHP	IB 0207-1	1225-25ECG	RHP	IB 0058-1	2-115	SEALMASTER	IB 0181-1	56206	FAG	IB 0082-1
1055-2 3/16DECG	RHP	IB 0220-1	1225-25ECG	SNR	IB 0058-1	2-12	SEALMASTER	IB 0076-1	56206.102	FAG	IB 0076-1
1055-2 3/16G	RHP	IB 0218-1	1225-25G	RHP	IB 0056-1	2-13	SEALMASTER	IB 0089-1	56206.103	FAG	IB 0089-1
1055-2DECG	RHP	IB 0199-1	1225-25G	SNR	IB 0056-1	2-14	SEALMASTER	IB 0101-1	56207	FAG	IB 0119-1
1055-2G	RHP	IB 0197-1	1225-7/8ECG	RHP	IB 0046-1	2-15	SEALMASTER	IB 0107-1	56207.104	FAG	IB 0101-1

BY PART NUMBER

Part No.	Brand	Group No.	Part No.	Brand	Group No.	Part No.	Brand	Group No.	Part No.	Brand	Group No.
56207.106	FAG	IB 0113-1	B 4	NACHI	IB 0033-1	EW 204	NSK	IB 0036-1	G1013KRRB	FAFNIR	IB 0041-1
56207.107	FAG	IB 0126-1	B 4-12	ASAHI	IB 0029-1	EW 204-12S	NSK	IB 0032-1	G1014KRRB	FAFNIR	IB 0047-1
56208	FAG	IB 0144-1	B 4-12	NACHI	IB 0029-1	EW 205	NSK	IB 0059-1	G1015KRRB	FAFNIR	IB 0053-1
56208.108	FAG	IB 0132-1	B 5	ASAHI	IB 0056-1	EW 205-13S	NSK	IB 0041-1	G1100KRRB	FAFNIR	IB 0066-1
56209	FAG	IB 0165-1	B 5	NACHI	IB 0056-1	EW 205-14S	NSK	IB 0047-1	G1101KRRB	FAFNIR	IB 0072-1
56209.112	FAG	IB 0160-1	B 5-14	ASAHI	IB 0044-1	EW 205-15S	NSK	IB 0053-1	G1102KRRB	FAFNIR	IB 0078-1
56210	FAG	IB 0186-1	B 5-14	NACHI	IB 0044-1	EW 205-16S	NSK	IB 0066-1	G1103KRRB	FAFNIR	IB 0091-1
56210.115	FAG	IB 0181-1	B 5-15	ASAHI	IB 0050-1	EW 206	NSK	IB 0084-1	G1103KRRB3	FAFNIR	IB 0097-1
56211	FAG	IB 0212-1	B 5-15	NACHI	IB 0050-1	EW 206-17S	NSK	IB 0072-1	G1104KRRB	FAFNIR	IB 0103-1
56211.200	FAG	IB 0197-1	B 5-16	ASAHI	IB 0063-1	EW 206-18S	NSK	IB 0078-1	G1105KRRB	FAFNIR	IB 0109-1
56211.203	FAG	IB 0218-1	B 5-16	NACHI	IB 0063-1	EW 206-19S	NSK	IB 0091-1	G1106KRRB	FAFNIR	IB 0115-1
56212	FAG	IB 0231-1	B 6	ASAHI	IB 0081-1	EW 206-20S	NSK	IB 0097-1	G1107KRRB	FAFNIR	IB 0128-1
56212.204	FAG	IB 0223-1	B 6	NACHI	IB 0081-1	EW 207	NSK	IB 0121-1	G1108KRRB	FAFNIR	IB 0134-1
56212.207	FAG	IB 0240-1	B 6-18	ASAHI	IB 0075-1	EW 207-20S	NSK	IB 0103-1	G1109KRRB	FAFNIR	IB 0140-1
AEL201-008W3	NTN	IB 0007-1	B 6-18	NACHI	IB 0075-1	EW 207-21S	NSK	IB 0109-1	G1110KRRB	FAFNIR	IB 0152-1
AEL201W3	NTN	IB 0003-1	B 6-19	ASAHI	IB 0088-1	EW 207-22S	NSK	IB 0115-1	G1111KRRB	FAFNIR	IB 0157-1
AEL202-009W3	NTN	IB 0011-1	B 6-19	NACHI	IB 0088-1	EW 207-23S	NSK	IB 0128-1	G1112KRRB	FAFNIR	IB 0162-1
AEL202-010W3	NTN	IB 0019-1	B 7	ASAHI	IB 0118-1	EW 208	NSK	IB 0146-1	G1113KRRB	FAFNIR	IB 0173-1
AEL202W3	NTN	IB 0015-1	B 7	NACHI	IB 0118-1	EW 208-24S	NSK	IB 0134-1	G1114KRRB	FAFNIR	IB 0178-1
AEL203-011W3	NTN	IB 0027-1	B 7-20	ASAHI	IB 0100-1	EW 209	NSK	IB 0167-1	G1115KRRB	FAFNIR	IB 0183-1
AEL203W3	NTN	IB 0023-1	B 7-20	NACHI	IB 0100-1	EW 209-26S	NSK	IB 0152-1	G1200KRRB	FAFNIR	IB 0199-1
AEL204-012W3	NTN	IB 0031-1	B 7-21	ASAHI	IB 0106-1	EW 209-27S	NSK	IB 0157-1	G1201KRRB	FAFNIR	IB 0204-1
AEL204W3	NTN	IB 0035-1	B 7-21	NACHI	IB 0106-1	EW 209-28S	NSK	IB 0162-1	G1202KRRB	FAFNIR	IB 0209-1
AEL205-013W3	NTN	IB 0040-1	B 7-22	ASAHI	IB 0112-1	EW 210	NSK	IB 0188-1	G1203KRRB	FAFNIR	IB 0220-1
AEL205-014W3	NTN	IB 0046-1	B 7-22	NACHI	IB 0112-1	EW 210-29S	NSK	IB 0173-1	G1204KRRB	FAFNIR	IB 0224-1
AEL205-015W3	NTN	IB 0052-1	B 7-23	ASAHI	IB 0125-1	EW 210-30S	NSK	IB 0178-1	G1205KRRB	FAFNIR	IB 0228-1
AEL205-100W3	NTN	IB 0065-1	B 7-23	NACHI	IB 0125-1	EW 210-31S	NSK	IB 0183-1	G1206KRRB	FAFNIR	IB 0237-1
AEL205W3	NTN	IB 0058-1	EN 201	NSK	IB 0003-1	EW 210-32S	NSK	IB 0194-1	G1207KRRB	FAFNIR	IB 0241-1
AEL207-104W3	NTN	IB 0102-1	EN 201-8S	NSK	IB 0007-1	EW 211	NSK	IB 0214-1	G1213KRRB	FAFNIR	IB 0273-1
AEL207-105W3	NTN	IB 0108-1	EN 202	NSK	IB 0015-1	EW 211-32S	NSK	IB 0199-1	G1214KRRB	FAFNIR	IB 0277-1
AEL207-106W3	NTN	IB 0114-1	EN 202-10S	NSK	IB 0019-1	EW 211-33S	NSK	IB 0204-1	G1215KRRB	FAFNIR	IB 0281-1
AEL207-107W3	NTN	IB 0127-1	EN 202-9S	NSK	IB 0011-1	EW 211-34S	NSK	IB 0209-1	GA 1012 2RSB	KOYO	IB 0032-1
AEL207W3	NTN	IB 0120-1	EN 203	NSK	IB 0023-1	EW 211-35S	NSK	IB 0220-1	GA 1012 M2RSB	KOYO	IB 0036-1
AS201	NTN	IB 0001-1	EN 203-11S	NSK	IB 0027-1	EW 212	NSK	IB 0232-1	GA 1013 2RSB	KOYO	IB 0041-1
AS201-008	NTN	IB 0005-1	EN 204	NSK	IB 0035-1	EW 212-36S	NSK	IB 0224-1	GA 1014 2RSB	KOYO	IB 0047-1
AS202	NTN	IB 0013-1	EN 204-12S	NSK	IB 0031-1	EW 212-37S	NSK	IB 0228-1	GA 1015 2RSB	KOYO	IB 0053-1
AS202-009	NTN	IB 0009-1	EN 205	NSK	IB 0058-1	EW 212-38S	NSK	IB 0237-1	GA 1100 2RSB	KOYO	IB 0066-1
AS202-010	NTN	IB 0017-1	EN 205-13S	NSK	IB 0040-1	EW 212-39S	NSK	IB 0241-1	GA 1100 M2RSB	KOYO	IB 0059-1
AS203	NTN	IB 0021-1	EN 205-14S	NSK	IB 0046-1	EW 213	NSK	IB 0249-1	GA 1102 2RSB	KOYO	IB 0078-1
AS203-011	NTN	IB 0025-1	EN 205-15S	NSK	IB 0052-1	EW 213-40S	NSK	IB 0245-1	GA 1103 2RSB	KOYO	IB 0091-1
AS204	NTN	IB 0033-1	EN 205-16S	NSK	IB 0065-1	EW 214	NSK	IB 0269-1	GA 1103 M2RSB	KOYO	IB 0084-1
AS204-012	NTN	IB 0029-1	EN 206	NSK	IB 0083-1	EW 214-42S	NSK	IB 0257-1	GA 1103-1 2RSB	KOYO	IB 0097-1
AS205	NTN	IB 0056-1	EN 206-17S	NSK	IB 0071-1	EW 214-43S	NSK	IB 0261-1	GA 1104 2RSB	KOYO	IB 0103-1
AS205-013	NTN	IB 0038-1	EN 206-18S	NSK	IB 0077-1	EW 214-44S	NSK	IB 0265-1	GA 1105 2RSB	KOYO	IB 0109-1
AS205-014	NTN	IB 0044-1	EN 206-19S	NSK	IB 0090-1	EW 215	NSK	IB 0285-1	GA 1106 2RSB	KOYO	IB 0115-1
AS205-015	NTN	IB 0050-1	EN 206-20S	NSK	IB 0096-1	EW 215-45S	NSK	IB 0273-1	GA 1106 M2RSB	KOYO	IB 0121-1
AS205-100	NTN	IB 0063-1	EN 207	NSK	IB 0120-1	EW 215-46S	NSK	IB 0277-1	GA 1107 2RSB	KOYO	IB 0128-1
AS206	NTN	IB 0081-1	EN 207-20S	NSK	IB 0102-1	EW 215-47S	NSK	IB 0281-1	GA 1108 2RSB	KOYO	IB 0134-1
AS206-101	NTN	IB 0069-1	EN 207-21S	NSK	IB 0108-1	EW 215-48S	NSK	IB 0289-1	GA 1109 2RSB	KOYO	IB 0140-1
AS206-102	NTN	IB 0075-1	EN 207-22S	NSK	IB 0114-1	G 1012 KRRB	INA	IB 0032-1	GA 1109 M2RSB	KOYO	IB 0146-1
AS206-103	NTN	IB 0088-1	EN 207-23S	NSK	IB 0127-1	G 1014 KRRB	INA	IB 0047-1	GA 1110 2RSB	KOYO	IB 0152-1
AS206-104	NTN	IB 0094-1	EN 208	NSK	IB 0145-1	G 1015 KRRB	INA	IB 0053-1	GA 1111 2RSB	KOYO	IB 0157-1
B 1	ASAHI	IB 0001-1	EN 208-24S	NSK	IB 0133-1	G 1100 KRRB	INA	IB 0066-1	GA 1112 2RSB	KOYO	IB 0162-1
B 1	NACHI	IB 0001-1	EN 209	NSK	IB 0166-1	G 1102 KRRB	INA	IB 0078-1	GA 1114 M2RSB	KOYO	IB 0167-1
B 1-8	ASAHI	IB 0005-1	EN 209-26S	NSK	IB 0151-1	G 1103 KRRB	INA	IB 0091-1	GA 1114 2RSB	KOYO	IB 0178-1
B 1-8	NACHI	IB 0005-1	EN 209-27S	NSK	IB 0156-1	G 1104 KRRB	INA	IB 0103-1	GA 1115 2RSB	KOYO	IB 0183-1
B 2	ASAHI	IB 0013-1	EN 209-28S	NSK	IB 0161-1	G 1104 KRRB-206	INA	IB 0097-1	GA 1115 M2RSB	KOYO	IB 0188-1
B 2	NACHI	IB 0013-1	EN 210	NSK	IB 0187-1	G 1106 KRRB	INA	IB 0115-1	GA 1203 M2RSB	KOYO	IB 0214-1
B 2-10	ASAHI	IB 0017-1	EN 210-29S	NSK	IB 0172-1	G 1107 KRRB	INA	IB 0128-1	GA 1206 M2RSB	KOYO	IB 0232-1
B 2-10	NACHI	IB 0017-1	EN 210-30S	NSK	IB 0177-1	G 1108 KRRB	INA	IB 0134-1	GARA 010 2RSA	KOYO	IB 0019-1
B 2-9	ASAHI	IB 0009-1	EN 210-31S	NSK	IB 0182-1	G 1110 KRRB	INA	IB 0152-1	GARA 012 2RSA	KOYO	IB 0031-1
B 2-9	NACHI	IB 0009-1	EN 210-32S	NSK	IB 0193-1	G 1111 KRRB	INA	IB 0157-1	GARA 012 M2RSA	KOYO	IB 0035-1
B 3	ASAHI	IB 0021-1	EN 211	NSK	IB 0213-1	G 1112 KRRB	INA	IB 0162-1	GARA 013 2RSA	KOYO	IB 0040-1
B 3	NACHI	IB 0021-1	EN 211-32S	NSK	IB 0198-1	G 1115 KRRB	INA	IB 0183-1	GARA 014 2RSA	KOYO	IB 0046-1
B 3-11	ASAHI	IB 0025-1	EN 211-33S	NSK	IB 0203-1	G 1203 KRRB	INA	IB 0220-1	GARA 015 2RSA	KOYO	IB 0052-1
B 3-11	NACHI	IB 0025-1	EN 211-34S	NSK	IB 0208-1	G 1207 KRRB	INA	IB 0241-1	GARA 100 2RSA	KOYO	IB 0065-1
B 4	ASAHI	IB 0033-1	EN 211-35S	NSK	IB 0219-1	G1012KRRB	FAFNIR	IB 0032-1	GARA 100 M2RSA	KOYO	IB 0058-1

BY PART NUMBER

Part No.	Brand	Group No.	Part No.	Brand	Group No.	Part No.	Brand	Group No.	Part No.	Brand	Group No.
GARA 102 2RSA	KOYO	IB 0077-1	GRA 102 NPPB	INA	IB 0077-1	GY 1207 KRRB	INA	IB 0240-1	KH 209-27 BE	ASAHI	IB 0156-1
GARA 103 2RSA	KOYO	IB 0090-1	GRA 103 NPPB	INA	IB 0090-1	GY 1208 KRRB	INA	IB 0246-1	KH 209-27 BE	NACHI	IB 0156-1
GARA 103 M2RSA	KOYO	IB 0083-1	GRA 104 NPPB	INA	IB 0102-1	GY 1208 KRRB-213	INA	IB 0244-1	KH 209-28 BE	ASAHI	IB 0161-1
GARA 103-1 2RSA	KOYO	IB 0096-1	GRA 104 NPPB-206	INA	IB 0096-1	GY 1215 KRRB	INA	IB 0280-1	KH 209-28 BE	NACHI	IB 0161-1
GARA 104 2RSA	KOYO	IB 0102-1	GRA 106 NPPB	INA	IB 0114-1	GY 1300 KRRB	INA	IB 0290-1	KH 210 BE	ASAHI	IB 0187-1
GARA 105 2RSA	KOYO	IB 0108-1	GRA 107 NPPB	INA	IB 0127-1	GYA014RRB	FAFNIR	IB 0044-1	KH 210 BE	NACHI	IB 0187-1
GARA 106 2RSA	KOYO	IB 0114-1	GRA 108 NPPB	INA	IB 0133-1	GYA015RRB	FAFNIR	IB 0050-1	KH 210-30 BE	ASAHI	IB 0177-1
GARA 106 M2RSA	KOYO	IB 0120-1	GRA 112 NPPB	INA	IB 0161-1	GYA100RRB	FAFNIR	IB 0063-1	KH 210-30 BE	NACHI	IB 0198-1
GARA 107 2RSA	KOYO	IB 0127-1	GRA 115 NPPB	INA	IB 0182-1	GYAE25RRB	FAFNIR	IB 0056-1	KH 210-31 BE	ASAHI	IB 0182-1
GARA 108 2RSA	KOYO	IB 0133-1	GRA 200 NPPB	INA	IB 0198-1	GYE 20 KRRB	INA	IB 0034-1	KH 210-31 BE	NACHI	IB 0182-1
GARA 109 2RSA	KOYO	IB 0139-1	GRA 203 NPPB	INA	IB 0219-1	GYE 25 KRRB	INA	IB 0057-1	KH 211 BE	ASAHI	IB 0213-1
GARA 109 M2RSA	KOYO	IB 0145-1	GRA008RRB	FAFNIR	IB 0007-1	GYE 30 KRRB	INA	IB 0082-1	KH 211 BE	NACHI	IB 0213-1
GARA 110 2RSA	KOYO	IB 0151-1	GRA009RRB	FAFNIR	IB 0011-1	GYE 35 KRRB	INA	IB 0119-1	KH 211-32 BE	ASAHI	IB 0198-1
GARA 111 2RSA	KOYO	IB 0156-1	GRA010RRB	FAFNIR	IB 0019-1	GYE 40 KRRB	INA	IB 0144-1	KH 211-32 BE	NACHI	IB 0198-1
GARA 112 2RSA	KOYO	IB 0161-1	GRA012RRB	FAFNIR	IB 0031-1	GYE 40 KRRB-209	INA	IB 0148-1	KH 211-34 BE	ASAHI	IB 0208-1
GARA 112 M2RSA	KOYO	IB 0166-1	GRA013RRB	FAFNIR	IB 0040-1	GYE 45 KRRB	INA	IB 0165-1	KH 211-34 BE	NACHI	IB 0208-1
GARA 114 2RSA	KOYO	IB 0177-1	GRA014RRB	FAFNIR	IB 0046-1	GYE 45 KRRB-210	INA	IB 0169-1	KH 211-35 BE	ASAHI	IB 0219-1
GARA 115 2RSA	KOYO	IB 0182-1	GRA015RRB	FAFNIR	IB 0052-1	GYE 50 KRRB	INA	IB 0186-1	KH 211-35 BE	NACHI	IB 0219-1
GARA 115 M2RSA	KOYO	IB 0187-1	GRA100RRB	FAFNIR	IB 0065-1	GYE 50 KRRB-211	INA	IB 0190-1	NA 201	FYH	IB 0004-1
GARA 200 2RSA	KOYO	IB 0198-1	GRA103RRB2	FAFNIR	IB 0096-1	GYE 55 KRRB	INA	IB 0212-1	NA 201-8	FYH	IB 0008-1
GARA 203 2RSA	KOYO	IB 0219-1	GRA104RRB	FAFNIR	IB 0102-1	GYE 60 KRRB	INA	IB 0231-1	NA 202	FYH	IB 0016-1
GARA 203 M2RSA	KOYO	IB 0213-1	GRA105RRB	FAFNIR	IB 0108-1	GYE 65 KRRB	INA	IB 0250-1	NA 202-10	FYH	IB 0020-1
GAY 008 NPPB	INA	IB 0005-1	GRA106RRB	FAFNIR	IB 0114-1	GYE 65 KRRB-213	INA	IB 0248-1	NA 202-9	FYH	IB 0012-1
GAY 010 NPPB	INA	IB 0017-1	GRA107RRB	FAFNIR	IB 0127-1	GYE 70 KRRB	INA	IB 0268-1	NA 203	FYH	IB 0024-1
GAY 012 NPPB	INA	IB 0029-1	GRA110RRB	FAFNIR	IB 0151-1	GYE 75 KRRB	INA	IB 0284-1	NA 203-11	FYH	IB 0028-1
GAY 100 NPPB	INA	IB 0063-1	GRA111RRB	FAFNIR	IB 0156-1	GYE 80 KRRB	INA	IB 0298-1	NA 204	FYH	IB 0036-1
GAY 103 NPPB	INA	IB 0088-1	GRA112RRB	FAFNIR	IB 0161-1	GYE 90 KRRB	INA	IB 0307-1	NA 204-12	FYH	IB 0032-1
GAY 104 NPPB	INA	IB 0100-1	GRA113RRB	FAFNIR	IB 0172-1				NA 205	FYH	IB 0059-1
GAY 107 NPPB	INA	IB 0125-1	GRA114RRB	FAFNIR	IB 0177-1	KH 201 AE	NACHI	IB 0003-1	NA 205-14	FYH	IB 0047-1
GAY 108 NPPB	INA	IB 0131-1	GRA115RRB	FAFNIR	IB 0182-1	KH 201-8 AE	ASAHI	IB 0007-1	NA 205-15	FYH	IB 0053-1
GAY 12 NPPB	INA	IB 0001-1	GRA200RRB	FAFNIR	IB 0198-1	KH 201-8 AE	NACHI	IB 0007-1	NA 205-16	FYH	IB 0066-1
GAY 15 NPPB	INA	IB 0013-1	GRA201RRB	FAFNIR	IB 0203-1	KH 202 AE	ASAHI	IB 0015-1	NA 206	FYH	IB 0084-1
GAY 17 NPPB	INA	IB 0021-1	GRA202RRB	FAFNIR	IB 0208-1	KH 202 AE	NACHI	IB 0015-1	NA 206-18	FYH	IB 0078-1
GAY 20 NPPB	INA	IB 0033-1	GRA203RRB	FAFNIR	IB 0219-1	KH 202-10 AE	ASAHI	IB 0019-1	NA 206-19	FYH	IB 0091-1
GAY 25 NPPB	INA	IB 0056-1	GRAE 12 NPPB	INA	IB 0003-1	KH 202-10 AE	NACHI	IB 0019-1	NA 206-20	FYH	IB 0097-1
GAY 30 NPPB	INA	IB 0081-1	GRAE 15 NPPB	INA	IB 0015-1	KH 202-9 AE	ASAHI	IB 0011-1	NA 207	FYH	IB 0121-1
GAY 35 NPPB	INA	IB 0118-1	GRAE 17 NPPB	INA	IB 0023-1	KH 202-9 AE	NACHI	IB 0011-1	NA 207-20	FYH	IB 0103-1
GAY 40 NPPB	INA	IB 0143-1	GRAE 20 NPPB	INA	IB 0035-1	KH 203 AE	ASAHI	IB 0023-1	NA 207-22	FYH	IB 0115-1
GE 20 KRRB	INA	IB 0036-1	GRAE 25 NPPB	INA	IB 0058-1	KH 203 AE	NACHI	IB 0023-1	NA 207-23	FYH	IB 0128-1
GE 25 KRRB	INA	IB 0059-1	GRAE 30 NPPB	INA	IB 0083-1	KH 203-11 AE	ASAHI	IB 0027-1	NA 208	FYH	IB 0146-1
GE 30 KRRB	INA	IB 0084-1	GRAE 35 NPPB	INA	IB 0120-1	KH 203-11 AE	NACHI	IB 0027-1	NA 208-24	FYH	IB 0134-1
GE 35 KRRB	INA	IB 0121-1	GRAE 40 NPPB	INA	IB 0145-1	KH 204 AE	ASAHI	IB 0035-1	NA 209	FYH	IB 0167-1
GE 40 KRRB	INA	IB 0146-1	GRAE 45 NPPB	INA	IB 0166-1	KH 204 AE	NACHI	IB 0035-1	NA 209-26	FYH	IB 0152-1
GE 45 KRRB	INA	IB 0167-1	GRAE 50 NPPB	INA	IB 0187-1	KH 204-12 AE	ASAHI	IB 0031-1	NA 209-27	FYH	IB 0157-1
GE 50 KRRB	INA	IB 0188-1	GRAE 55 NPPB	INA	IB 0213-1	KH 204-12 AE	NACHI	IB 0031-1	NA 209-28	FYH	IB 0162-1
GE 55 KRRB	INA	IB 0214-1	GRAE17RRB	FAFNIR	IB 0023-1	KH 205 AE	ASAHI	IB 0058-1	NA 210	FYH	IB 0188-1
GE 60 KRRB	INA	IB 0232-1	GRAE20RRB	FAFNIR	IB 0035-1	KH 205 AE	NACHI	IB 0058-1	NA 210-31	FYH	IB 0183-1
GE20KRRB	FAFNIR	IB 0036-1	GRAE25RRB	FAFNIR	IB 0058-1	KH 205-14 AE	ASAHI	IB 0046-1	NA 211	FYH	IB 0214-1
GE25KRRB	FAFNIR	IB 0059-1	GRAE35RRB	FAFNIR	IB 0120-1	KH 205-14 AE	NACHI	IB 0046-1	NA 211-32	FYH	IB 0199-1
GE30KRRB	FAFNIR	IB 0084-1	GRAE45RRB	FAFNIR	IB 0166-1	KH 205-15 AE	ASAHI	IB 0052-1	NA 211-35	FYH	IB 0220-1
GE35KRRB	FAFNIR	IB 0121-1	GRAE50RRB	FAFNIR	IB 0187-1	KH 205-15 AE	NACHI	IB 0052-1	NA 212	FYH	IB 0232-1
GE40KRRB	FAFNIR	IB 0146-1	GRAE55RRB	FAFNIR	IB 0213-1	KH 205-16 AE	ASAHI	IB 0065-1	NA 212-36	FYH	IB 0224-1
GE45KRRB	FAFNIR	IB 0167-1	GY 1012 KRRB	INA	IB 0030-1	KH 205-16 AE	NACHI	IB 0065-1	NA 212-39	FYH	IB 0241-1
GE50KRRB	FAFNIR	IB 0188-1	GY 1014 KRRB	INA	IB 0045-1	KH 207 AE	ASAHI	IB 0120-1	NA 213-40	FYH	IB 0245-1
GE55KRRB	FAFNIR	IB 0214-1	GY 1100 KRRB	INA	IB 0064-1	KH 207 AE	NACHI	IB 0120-1	NA 215-47	FYH	IB 0281-1
GE60KRRB	FAFNIR	IB 0232-1	GY 1102 KRRB	INA	IB 0076-1	KH 207-20 AE	ASAHI	IB 0102-1	PB 10	KOYO	IB 0017-1
GE75KRRB	FAFNIR	IB 0285-1	GY 1104 KRRB	INA	IB 0098-1	KH 207-20 AE	NACHI	IB 0102-1	PB 11	KOYO	IB 0025-1
GNYE 30 KRRB	INA	IB 0087-1	GY 1104 KRRB	INA	IB 0101-1	KH 207-21 AE	ASAHI	IB 0108-1	PB 11 M	KOYO	IB 0021-1
GNYE 40 KRRB	INA	IB 0149-1	GY 1104 KRRB-206	INA	IB 0095-1	KH 207-21 AE	NACHI	IB 0108-1	PB 12	KOYO	IB 0029-1
GNYE 50 KRRB	INA	IB 0191-1	GY 1106 KRRB	INA	IB 0113-1	KH 207-22 AE	ASAHI	IB 0114-1	PB 12 M	KOYO	IB 0033-1
GNYE 60 KRRB	INA	IB 0235-1	GY 1108 KRRB	INA	IB 0132-1	KH 207-22 AE	NACHI	IB 0114-1	PB 13	KOYO	IB 0038-1
GRA 008 NPPB	INA	IB 0007-1	GY 1108 KRRB-209	INA	IB 0135-1	KH 207-23 AE	ASAHI	IB 0127-1	PB 14	KOYO	IB 0044-1
GRA 010 NPPB	INA	IB 0019-1	GY 1112 KRRB	INA	IB 0160-1	KH 207-23 AE	NACHI	IB 0127-1	PB 15	KOYO	IB 0050-1
GRA 012 NPPB	INA	IB 0031-1	GY 1112 KRRB-210	INA	IB 0163-1	KH 209 BE	ASAHI	IB 0166-1	PB 16	KOYO	IB 0063-1
GRA 014 NPPB	INA	IB 0046-1	GY 1115 KRRB	INA	IB 0181-1	KH 209 BE	NACHI	IB 0166-1	PB 16 M	KOYO	IB 0056-1
GRA 100 NPPB	INA	IB 0065-1	GY 1200 KRRB	INA	IB 0195-1	KH 209-26 BE	ASAHI	IB 0151-1	PB 18	KOYO	IB 0075-1
GRA 101 NPPB	INA	IB 0071-1	GY 1200 KRRB	INA	IB 0197-1	KH 209-26 BE	NACHI	IB 0151-1	PB 19	KOYO	IB 0088-1

BY PART NUMBER

Part No.	Brand	Group No.	Part No.	Brand	Group No.	Part No.	Brand	Group No.	Part No.	Brand	Group No.
PB 19 M	KOYO	IB 0081-1	SB 201	SLB	IB 0001-1	UB 207-20S	NSK	IB 0100-1	UC 205-15	SLB	IB 0051-1
PB 20	KOYO	IB 0094-1	SB 201	FYH	IB 0001-1	UB 207-21S	NSK	IB 0106-1	UC 205-15	ASAHI	IB 0051-1
PB 21	KOYO	IB 0106-1	SB 201-8	SLB	IB 0005-1	UB 207-22S	NSK	IB 0112-1	UC 205-15	FYH	IB 0051-1
PB 22	KOYO	IB 0112-1	SB 201-8	FYH	IB 0005-1	UB 207-23S	NSK	IB 0125-1	UC 205-15	NACHI	IB 0051-1
PB 22 M	KOYO	IB 0118-1	SB 202	SLB	IB 0013-1	UB 208	NSK	IB 0143-1	UC 205-15S	NSK	IB 0051-1
PB 23	KOYO	IB 0125-1	SB 202	FYH	IB 0013-1	UB 208-24S	NSK	IB 0131-1	UC 205-16	KOYO	IB 0064-1
SA 201	SLB	IB 0003-1	SB 202-10	SLB	IB 0017-1	UC 201	SLB	IB 0002-1	UC 205-16	SLB	IB 0064-1
SA 201	FYH	IB 0003-1	SB 202-10	FYH	IB 0017-1	UC 201	ASAHI	IB 0002-1	UC 205-16	ASAHI	IB 0064-1
SA 201-8	SLB	IB 0007-1	SB 202-9	SLB	IB 0009-1	UC 201	FYH	IB 0002-1	UC 205-16	FYH	IB 0064-1
SA 201-8	FYH	IB 0007-1	SB 203	SLB	IB 0021-1	UC 201	NACHI	IB 0002-1	UC 205-16	NACHI	IB 0064-1
SA 202	SLB	IB 0015-1	SB 203	FYH	IB 0021-1	UC 201	NSK	IB 0002-1	UC 205-16S	NSK	IB 0064-1
SA 202	FYH	IB 0015-1	SB 203-11	SLB	IB 0025-1	UC 201-8	SLB	IB 0006-1	UC 206	KOYO	IB 0082-1
SA 202-10	SLB	IB 0019-1	SB 204	SLB	IB 0033-1	UC 201-8	ASAHI	IB 0006-1	UC 206	SLB	IB 0082-1
SA 202-10	FYH	IB 0019-1	SB 204	FYH	IB 0033-1	UC 201-8	FYH	IB 0006-1	UC 206	ASAHI	IB 0082-1
SA 202-9	SLB	IB 0011-1	SB 204-12	SLB	IB 0029-1	UC 201-8	NACHI	IB 0006-1	UC 206	FYH	IB 0082-1
SA 203	SLB	IB 0023-1	SB 204-12	FYH	IB 0029-1	UC 201-8S	NSK	IB 0006-1	UC 206	NACHI	IB 0082-1
SA 203	FYH	IB 0023-1	SB 205	SLB	IB 0056-1	UC 202	SLB	IB 0014-1	UC 206	NSK	IB 0082-1
SA 203-11	SLB	IB 0027-1	SB 205	FYH	IB 0056-1	UC 202	ASAHI	IB 0014-1	UC 206-17	SLB	IB 0070-1
SA 204	SLB	IB 0035-1	SB 205-13	SLB	IB 0038-1	UC 202	FYH	IB 0014-1	UC 206-17	ASAHI	IB 0070-1
SA 204	FYH	IB 0035-1	SB 205-14	SLB	IB 0044-1	UC 202	NACHI	IB 0014-1	UC 206-17	NACHI	IB 0070-1
SA 204-12	SLB	IB 0031-1	SB 205-14	FYH	IB 0044-1	UC 202	NSK	IB 0014-1	UC 206-17S	NSK	IB 0070-1
SA 204-12	FYH	IB 0031-1	SB 205-15	SLB	IB 0050-1	UC 202-10	SLB	IB 0018-1	UC 206-18	KOYO	IB 0076-1
SA 205	SLB	IB 0058-1	SB 205-16	SLB	IB 0063-1	UC 202-10	ASAHI	IB 0018-1	UC 206-18	SLB	IB 0076-1
SA 205	FYH	IB 0058-1	SB 205-16	FYH	IB 0063-1	UC 202-10	FYH	IB 0018-1	UC 206-18	ASAHI	IB 0076-1
SA 205-13	SLB	IB 0040-1	SB 206	SLB	IB 0081-1	UC 202-10	NACHI	IB 0018-1	UC 206-18	FYH	IB 0076-1
SA 205-14	SLB	IB 0046-1	SB 206	FYH	IB 0081-1	UC 202-10S	NSK	IB 0018-1	UC 206-18	NACHI	IB 0076-1
SA 205-14	FYH	IB 0046-1	SB 206-17	SLB	IB 0069-1	UC 202-9	SLB	IB 0010-1	UC 206-18S	NSK	IB 0076-1
SA 205-15	SLB	IB 0052-1	SB 206-18	SLB	IB 0075-1	UC 202-9	ASAHI	IB 0010-1	UC 206-19	KOYO	IB 0089-1
SA 205-16	SLB	IB 0065-1	SB 206-18	FYH	IB 0075-1	UC 202-9	NACHI	IB 0010-1	UC 206-19	SLB	IB 0089-1
SA 205-16	FYH	IB 0065-1	SB 206-19	SLB	IB 0088-1	UC 202-9S	NSK	IB 0010-1	UC 206-19	ASAHI	IB 0089-1
SA 206	SLB	IB 0083-1	SB 206-19	FYH	IB 0088-1	UC 203	SLB	IB 0022-1	UC 206-19	FYH	IB 0089-1
SA 206	FYH	IB 0083-1	SB 206-20	SLB	IB 0094-1	UC 203	ASAHI	IB 0022-1	UC 206-19	NACHI	IB 0089-1
SA 206-17	SLB	IB 0071-1	SB 207	SLB	IB 0118-1	UC 203	FYH	IB 0022-1	UC 206-19S	NSK	IB 0089-1
SA 206-18	SLB	IB 0077-1	SB 207	FYH	IB 0118-1	UC 203	NACHI	IB 0022-1	UC 206-20	SLB	IB 0095-1
SA 206-18	FYH	IB 0077-1	SB 207-20	SLB	IB 0100-1	UC 203	NSK	IB 0022-1	UC 206-20S	NSK	IB 0095-1
SA 206-19	SLB	IB 0090-1	SB 207-20	FYH	IB 0100-1	UC 203-11	SLB	IB 0026-1	UC 207	KOYO	IB 0119-1
SA 206-19	FYH	IB 0090-1	SB 207-21	SLB	IB 0106-1	UC 203-11	ASAHI	IB 0026-1	UC 207	SLB	IB 0119-1
SA 206-20	SLB	IB 0096-1	SB 207-22	SLB	IB 0112-1	UC 203-11	NACHI	IB 0026-1	UC 207	ASAHI	IB 0119-1
SA 206-20	FYH	IB 0096-1	SB 207-22	FYH	IB 0112-1	UC 203-11S	NSK	IB 0026-1	UC 207	FYH	IB 0119-1
SA 207	SLB	IB 0120-1	SB 207-23	SLB	IB 0125-1	UC 204	KOYO	IB 0034-1	UC 207	NACHI	IB 0119-1
SA 207	FYH	IB 0120-1	SB 207-23	FYH	IB 0125-1	UC 204	SLB	IB 0034-1	UC 207	NSK	IB 0119-1
SA 207-20	SLB	IB 0102-1	SB 208	SLB	IB 0143-1	UC 204	ASAHI	IB 0034-1	UC 207-20	KOYO	IB 0101-1
SA 207-20	FYH	IB 0102-1	SB 208	FYH	IB 0143-1	UC 204	NACHI	IB 0034-1	UC 207-20	SLB	IB 0101-1
SA 207-21	SLB	IB 0108-1	SB 208-24	SLB	IB 0131-1	UC 204	FYH	IB 0034-1	UC 207-20	ASAHI	IB 0101-1
SA 207-22	SLB	IB 0114-1	SB 208-24	FYH	IB 0131-1	UC 204	NSK	IB 0034-1	UC 207-20	FYH	IB 0101-1
SA 207-22	FYH	IB 0114-1	SB 208-25	SLB	IB 0137-1	UC 204-12	KOYO	IB 0030-1	UC 207-20	NACHI	IB 0101-1
SA 207-23	SLB	IB 0127-1	SB 208-25	FYH	IB 0137-1	UC 204-12	SLB	IB 0030-1	UC 207-20S	NSK	IB 0101-1
SA 207-23	FYH	IB 0127-1	UB 201	NSK	IB 0001-1	UC 204-12	ASAHI	IB 0030-1	UC 207-21	KOYO	IB 0107-1
SA 208	SLB	IB 0145-1	UB 201-8S	NSK	IB 0005-1	UC 204-12	FYH	IB 0030-1	UC 207-21	SLB	IB 0107-1
SA 208	FYH	IB 0145-1	UB 202	NSK	IB 0013-1	UC 204-12	NACHI	IB 0030-1	UC 207-21	ASAHI	IB 0107-1
SA 208-24	SLB	IB 0133-1	UB 202-10S	NSK	IB 0017-1	UC 204-12S	NSK	IB 0030-1	UC 207-21	FYH	IB 0107-1
SA 208-24	FYH	IB 0133-1	UB 202-9S	NSK	IB 0009-1	UC 205	KOYO	IB 0057-1	UC 207-21	NACHI	IB 0107-1
SA 208-25	SLB	IB 0139-1	UB 203	NSK	IB 0021-1	UC 205	SLB	IB 0057-1	UC 207-21S	NSK	IB 0107-1
SA 209	SLB	IB 0166-1	UB 203-11S	NSK	IB 0025-1	UC 205	ASAHI	IB 0057-1	UC 207-22	KOYO	IB 0113-1
SA 209-26	SLB	IB 0151-1	UB 204	NSK	IB 0033-1	UC 205	FYH	IB 0057-1	UC 207-22	SLB	IB 0113-1
SA 209-27	SLB	IB 0156-1	UB 204-12S	NSK	IB 0029-1	UC 205	NACHI	IB 0057-1	UC 207-22	ASAHI	IB 0113-1
SA 209-28	SLB	IB 0161-1	UB 205	NSK	IB 0056-1	UC 205	NSK	IB 0057-1	UC 207-22	FYH	IB 0113-1
SA 210	SLB	IB 0187-1	UB 205-13S	NSK	IB 0038-1	UC 205-13	KOYO	IB 0039-1	UC 207-22	NACHI	IB 0113-1
SA 210-29	SLB	IB 0172-1	UB 205-14S	NSK	IB 0044-1	UC 205-13	SLB	IB 0039-1	UC 207-22S	NSK	IB 0113-1
SA 210-30	SLB	IB 0177-1	UB 205-15S	NSK	IB 0050-1	UC 205-13S	NSK	IB 0039-1	UC 207-23	KOYO	IB 0126-1
SA 210-31	SLB	IB 0182-1	UB 205-16S	NSK	IB 0063-1	UC 205-14	KOYO	IB 0045-1	UC 207-23	SLB	IB 0126-1
SA 210-32	SLB	IB 0193-1	UB 206	NSK	IB 0081-1	UC 205-14	SLB	IB 0045-1	UC 207-23	ASAHI	IB 0126-1
SA 211	SLB	IB 0213-1	UB 206-17S	NSK	IB 0069-1	UC 205-14	ASAHI	IB 0045-1	UC 207-23	FYH	IB 0126-1
SA 211-32	SLB	IB 0198-1	UB 206-18S	NSK	IB 0075-1	UC 205-14	FYH	IB 0045-1	UC 207-23	NACHI	IB 0126-1
SA 211-33	SLB	IB 0203-1	UB 206-19S	NSK	IB 0088-1	UC 205-14	NACHI	IB 0045-1	UC 207-23S	NSK	IB 0126-1
SA 211-34	SLB	IB 0208-1	UB 206-20S	NSK	IB 0094-1	UC 205-14S	NSK	IB 0045-1	UC 208	KOYO	IB 0144-1
SA 211-35	SLB	IB 0219-1	UB 207	NSK	IB 0118-1	UC 205-15	KOYO	IB 0051-1	UC 208	SLB	IB 0144-1

BY PART NUMBER

Part No.	Brand	Group No.	Part No.	Brand	Group No.	Part No.	Brand	Group No.	Part No.	Brand	Group No.
UC 208	ASAHI	IB 0144-1	UC 211-32	KOYO	IB 0197-1	UC 214-43	SLB	IB 0260-1	UC 305-13S	NSK	IB 0043-1
UC 208	FYH	IB 0144-1	UC 211-32	SLB	IB 0197-1	UC 214-43S	NSK	IB 0260-1	UC 305-14	SLB	IB 0049-1
UC 208	NACHI	IB 0144-1	UC 211-32	ASAHI	IB 0197-1	UC 214-44	SLB	IB 0264-1	UC 305-14	ASAHI	IB 0049-1
UC 208	NSK	IB 0144-1	UC 211-32	FYH	IB 0197-1	UC 214-44	ASAHI	IB 0264-1	UC 305-14S	NSK	IB 0049-1
UC 208-24	KOYO	IB 0132-1	UC 211-32	NACHI	IB 0197-1	UC 214-44	FYH	IB 0264-1	UC 305-15	SLB	IB 0055-1
UC 208-24	SLB	IB 0132-1	UC 211-32S	NSK	IB 0197-1	UC 214-44	NACHI	IB 0264-1	UC 305-15S	NSK	IB 0055-1
UC 208-24	ASAHI	IB 0132-1	UC 211-33	SLB	IB 0202-1	UC 214-44S	NSK	IB 0264-1	UC 305-16	SLB	IB 0068-1
UC 208-24	FYH	IB 0132-1	UC 211-33	ASAHI	IB 0202-1	UC 215	KOYO	IB 0284-1	UC 305-16	ASAHI	IB 0068-1
UC 208-24	NACHI	IB 0132-1	UC 211-33	NACHI	IB 0202-1	UC 215	SLB	IB 0284-1	UC 305-16	FYH	IB 0068-1
UC 208-24S	NSK	IB 0132-1	UC 211-33S	NSK	IB 0202-1	UC 215	ASAHI	IB 0284-1	UC 305-16S	NSK	IB 0068-1
UC 208-25	KOYO	IB 0138-1	UC 211-34	SLB	IB 0207-1	UC 215	FYH	IB 0284-1	UC 306	SLB	IB 0087-1
UC 208-25	SLB	IB 0138-1	UC 211-34	ASAHI	IB 0207-1	UC 215	NACHI	IB 0284-1	UC 306	ASAHI	IB 0087-1
UC 208-25	ASAHI	IB 0138-1	UC 211-34	FYH	IB 0207-1	UC 215	NSK	IB 0284-1	UC 306	FYH	IB 0087-1
UC 208-25	FYH	IB 0138-1	UC 211-34	NACHI	IB 0207-1	UC 215-45	SLB	IB 0272-1	UC 306	NSK	IB 0087-1
UC 208-25	NACHI	IB 0138-1	UC 211-34S	NSK	IB 0207-1	UC 215-45S	NSK	IB 0272-1	UC 306-17	SLB	IB 0074-1
UC 209	KOYO	IB 0165-1	UC 211-35	KOYO	IB 0218-1	UC 215-46	SLB	IB 0276-1	UC 306-17S	NSK	IB 0074-1
UC 209	SLB	IB 0165-1	UC 211-35	SLB	IB 0218-1	UC 215-46S	NSK	IB 0276-1	UC 306-18	SLB	IB 0080-1
UC 209	ASAHI	IB 0165-1	UC 211-35	ASAHI	IB 0218-1	UC 215-47	KOYO	IB 0280-1	UC 306-18	ASAHI	IB 0080-1
UC 209	FYH	IB 0165-1	UC 211-35	FYH	IB 0218-1	UC 215-47	SLB	IB 0280-1	UC 306-18	FYH	IB 0080-1
UC 209	NACHI	IB 0165-1	UC 211-35	NACHI	IB 0218-1	UC 215-47S	NSK	IB 0280-1	UC 306-18S	NSK	IB 0080-1
UC 209	NSK	IB 0165-1	UC 211-35S	NSK	IB 0218-1	UC 215-48	SLB	IB 0288-1	UC 306-19	SLB	IB 0093-1
UC 209-26	KOYO	IB 0150-1	UC 212	KOYO	IB 0231-1	UC 215-48	ASAHI	IB 0288-1	UC 306-19S	NSK	IB 0093-1
UC 209-26	SLB	IB 0150-1	UC 212	SLB	IB 0231-1	UC 215-48	FYH	IB 0288-1	UC 306-20	SLB	IB 0099-1
UC 209-26	ASAHI	IB 0150-1	UC 212	ASAHI	IB 0231-1	UC 215-48	NACHI	IB 0288-1	UC 306-20S	NSK	IB 0099-1
UC 209-26	FYH	IB 0150-1	UC 212	FYH	IB 0231-1	UC 215-48S	NSK	IB 0288-1	UC 307	SLB	IB 0124-1
UC 209-26	NACHI	IB 0150-1	UC 212	NACHI	IB 0231-1	UC 216	KOYO	IB 0298-1	UC 307	ASAHI	IB 0124-1
UC 209-26S	NSK	IB 0150-1	UC 212	NSK	IB 0231-1	UC 216	SLB	IB 0298-1	UC 307	FYH	IB 0124-1
UC 209-27	KOYO	IB 0155-1	UC 212-36	KOYO	IB 0223-1	UC 216	ASAHI	IB 0298-1	UC 307	NSK	IB 0124-1
UC 209-27	SLB	IB 0155-1	UC 212-36	SLB	IB 0223-1	UC 216	FYH	IB 0298-1	UC 307-20	SLB	IB 0105-1
UC 209-27	ASAHI	IB 0155-1	UC 212-36	ASAHI	IB 0223-1	UC 216	NACHI	IB 0298-1	UC 307-20	ASAHI	IB 0105-1
UC 209-27	FYH	IB 0155-1	UC 212-36	FYH	IB 0223-1	UC 216	NSK	IB 0298-1	UC 307-20	FYH	IB 0105-1
UC 209-27	NACHI	IB 0155-1	UC 212-36	NACHI	IB 0223-1	UC 216-49	SLB	IB 0292-1	UC 307-20S	NSK	IB 0105-1
UC 209-27S	NSK	IB 0155-1	UC 212-36S	NSK	IB 0223-1	UC 216-50	SLB	IB 0295-1	UC 307-21	SLB	IB 0111-1
UC 209-28	KOYO	IB 0160-1	UC 212-37	SLB	IB 0227-1	UC 216-50	ASAHI	IB 0295-1	UC 307-21S	NSK	IB 0111-1
UC 209-28	SLB	IB 0160-1	UC 212-37S	NSK	IB 0227-1	UC 216-50	NACHI	IB 0295-1	UC 307-22	SLB	IB 0117-1
UC 209-28	ASAHI	IB 0160-1	UC 212-38	SLB	IB 0236-1	UC 216-50S	NSK	IB 0295-1	UC 307-22	ASAHI	IB 0117-1
UC 209-28	FYH	IB 0160-1	UC 212-38	ASAHI	IB 0236-1	UC 216-51	SLB	IB 0301-1	UC 307-22	FYH	IB 0117-1
UC 209-28	NACHI	IB 0160-1	UC 212-38	FYH	IB 0236-1	UC 217	KOYO	IB 0304-1	UC 307-22S	NSK	IB 0117-1
UC 209-28S	NSK	IB 0160-1	UC 212-38	NACHI	IB 0236-1	UC 217	SLB	IB 0304-1	UC 307-23	SLB	IB 0130-1
UC 210	KOYO	IB 0186-1	UC 212-38S	NSK	IB 0236-1	UC 217	ASAHI	IB 0304-1	UC 307-23S	NSK	IB 0130-1
UC 210	SLB	IB 0186-1	UC 212-39	KOYO	IB 0240-1	UC 217	FYH	IB 0304-1	UC 308	SLB	IB 0149-1
UC 210	ASAHI	IB 0186-1	UC 212-39	SLB	IB 0240-1	UC 217	NACHI	IB 0304-1	UC 308	ASAHI	IB 0149-1
UC 210	FYH	IB 0186-1	UC 212-39	ASAHI	IB 0240-1	UC 217	NSK	IB 0304-1	UC 308	FYH	IB 0149-1
UC 210	NACHI	IB 0186-1	UC 212-39	FYH	IB 0240-1	UC 217-52	SLB	IB 0302-1	UC 308	NSK	IB 0149-1
UC 210	NSK	IB 0186-1	UC 212-39	NACHI	IB 0240-1	UC 217-52	ASAHI	IB 0302-1	UC 308-24	SLB	IB 0136-1
UC 210-29	SLB	IB 0171-1	UC 212-39S	NSK	IB 0240-1	UC 217-52	FYH	IB 0302-1	UC 308-24	ASAHI	IB 0136-1
UC 210-29S	NSK	IB 0171-1	UC 213	KOYO	IB 0248-1	UC 217-52	NACHI	IB 0302-1	UC 308-24	FYH	IB 0136-1
UC 210-30	KOYO	IB 0176-1	UC 213	SLB	IB 0248-1	UC 217-52S	NSK	IB 0302-1	UC 308-24S	NSK	IB 0136-1
UC 210-30	SLB	IB 0176-1	UC 213	ASAHI	IB 0248-1	UC 217-53	SLB	IB 0303-1	UC 308-25	SLB	IB 0142-1
UC 210-30	ASAHI	IB 0176-1	UC 213	FYH	IB 0248-1	UC 217-55	SLB	IB 0305-1	UC 309	SLB	IB 0170-1
UC 210-30	FYH	IB 0176-1	UC 213	NACHI	IB 0248-1	UC 217-55S	NSK	IB 0305-1	UC 309	ASAHI	IB 0170-1
UC 210-30	NACHI	IB 0176-1	UC 213	NSK	IB 0248-1	UC 218	KOYO	IB 0307-1	UC 309	FYH	IB 0170-1
UC 210-30S	NSK	IB 0176-1	UC 213-40	KOYO	IB 0244-1	UC 218	SLB	IB 0307-1	UC 309	NSK	IB 0170-1
UC 210-31	KOYO	IB 0181-1	UC 213-40	SLB	IB 0244-1	UC 218	ASAHI	IB 0307-1	UC 309-26	SLB	IB 0154-1
UC 210-31	SLB	IB 0181-1	UC 213-40	ASAHI	IB 0244-1	UC 218	FYH	IB 0307-1	UC 309-26	ASAHI	IB 0154-1
UC 210-31	ASAHI	IB 0181-1	UC 213-40	FYH	IB 0244-1	UC 218	NACHI	IB 0307-1	UC 309-26S	NSK	IB 0154-1
UC 210-31	FYH	IB 0181-1	UC 213-40	NACHI	IB 0244-1	UC 218	NSK	IB 0307-1	UC 309-27	SLB	IB 0159-1
UC 210-31	NACHI	IB 0181-1	UC 213-40S	NSK	IB 0244-1	UC 218-56	SLB	IB 0306-1	UC 309-27S	NSK	IB 0159-1
UC 210-31S	NSK	IB 0181-1	UC 213-41	SLB	IB 0252-1	UC 218-56	ASAHI	IB 0306-1	UC 309-28	SLB	IB 0164-1
UC 210-32	SLB	IB 0192-1	UC 214	KOYO	IB 0268-1	UC 218-56	FYH	IB 0306-1	UC 309-28	ASAHI	IB 0164-1
UC 210-32S	NSK	IB 0192-1	UC 214	SLB	IB 0268-1	UC 218-56	NACHI	IB 0306-1	UC 309-28	FYH	IB 0164-1
UC 211	KOYO	IB 0212-1	UC 214	ASAHI	IB 0268-1	UC 218-56S	NSK	IB 0306-1	UC 309-28S	NSK	IB 0164-1
UC 211	SLB	IB 0212-1	UC 214	FYH	IB 0268-1	UC 305	SLB	IB 0062-1	UC 310	SLB	IB 0191-1
UC 211	ASAHI	IB 0212-1	UC 214	NACHI	IB 0268-1	UC 305	ASAHI	IB 0062-1	UC 310	ASAHI	IB 0191-1
UC 211	FYH	IB 0212-1	UC 214	NSK	IB 0268-1	UC 305	FYH	IB 0062-1	UC 310	FYH	IB 0191-1
UC 211	NACHI	IB 0212-1	UC 214-42	SLB	IB 0256-1	UC 305	NSK	IB 0062-1	UC 310	NSK	IB 0191-1
UC 211	NSK	IB 0212-1	UC 214-42S	NSK	IB 0256-1	UC 305-13	SLB	IB 0043-1	UC 310-29	SLB	IB 0175-1

BY PART NUMBER

Part No.	Brand	Group No.	Part No.	Brand	Group No.	Part No.	Brand	Group No.	Part No.	Brand	Group No.
UC 310-29S	NSK	IB 0175-1	UC 315-47	SLB	IB 0283-1	UC X08-24	SLB	IB 0135-1	UC X12-39	ASAHI	IB 0242-1
UC 310-30	SLB	IB 0180-1	UC 315-47S	NSK	IB 0283-1	UC X08-24	ASAHI	IB 0135-1	UC X12-39	FYH	IB 0242-1
UC 310-30	ASAHI	IB 0180-1	UC 315-48	SLB	IB 0291-1	UC X08-24	FYH	IB 0135-1	UC X12-39S	NSK	IB 0242-1
UC 310-30S	NSK	IB 0180-1	UC 315-48	ASAHI	IB 0291-1	UC X08-24S	NSK	IB 0135-1	UC X13	SLB	IB 0250-1
UC 310-31	FYH	IB 0185-1	UC 315-48	FYH	IB 0291-1	UC X08-25	SLB	IB 0141-1	UC X13	ASAHI	IB 0250-1
UC 310-31	SLB	IB 0185-1	UC 315-48S	NSK	IB 0291-1	UC X09	SLB	IB 0169-1	UC X13	FYH	IB 0250-1
UC 310-31S	NSK	IB 0185-1	UC 316	SLB	IB 0300-1	UC X09	ASAHI	IB 0169-1	UC X13	NSK	IB 0250-1
UC 310-32	SLB	IB 0196-1	UC 316	ASAHI	IB 0300-1	UC X09	FYH	IB 0169-1	UC X13-40	SLB	IB 0246-1
UC 310-32S	NSK	IB 0196-1	UC 316	FYH	IB 0300-1	UC X09	NSK	IB 0169-1	UC X13-40	ASAHI	IB 0246-1
UC 311	SLB	IB 0217-1	UC 316	NSK	IB 0300-1	UC X09-26	SLB	IB 0153-1	UC X13-40	FYH	IB 0246-1
UC 311	ASAHI	IB 0217-1	UC 316-49	SLB	IB 0294-1	UC X09-26	ASAHI	IB 0153-1	UC X13-40S	NSK	IB 0246-1
UC 311	FYH	IB 0217-1	UC 316-50	SLB	IB 0297-1	UC X09-26S	NSK	IB 0153-1	UC X13-41	SLB	IB 0254-1
UC 311	NSK	IB 0217-1	UC 316-50	ASAHI	IB 0297-1	UC X09-27	SLB	IB 0158-1	UC X14	SLB	IB 0270-1
UC 311-32	SLB	IB 0201-1	UC 316-50S	NSK	IB 0297-1	UC X09-27	ASAHI	IB 0158-1	UC X14	ASAHI	IB 0270-1
UC 311-32	ASAHI	IB 0201-1	UC X05	SLB	IB 0061-1	UC X09-27	FYH	IB 0158-1	UC X14	FYH	IB 0270-1
UC 311-32	FYH	IB 0201-1	UC X05	ASAHI	IB 0061-1	UC X09-27S	NSK	IB 0158-1	UC X14	NSK	IB 0270-1
UC 311-32S	NSK	IB 0201-1	UC X05	FYH	IB 0061-1	UC X09-28	SLB	IB 0163-1	UC X14-42	SLB	IB 0258-1
UC 311-33	SLB	IB 0206-1	UC X05	NSK	IB 0061-1	UC X09-28	ASAHI	IB 0163-1	UC X14-42S	NSK	IB 0258-1
UC 311-33S	NSK	IB 0206-1	UC X05-13	SLB	IB 0042-1	UC X09-28	FYH	IB 0163-1	UC X14-43	SLB	IB 0262-1
UC 311-34	SLB	IB 0211-1	UC X05-13S	NSK	IB 0042-1	UC X09-28S	NSK	IB 0163-1	UC X14-43	ASAHI	IB 0262-1
UC 311-34	ASAHI	IB 0211-1	UC X05-14	SLB	IB 0048-1	UC X10	SLB	IB 0190-1	UC X14-43S	NSK	IB 0262-1
UC 311-34S	NSK	IB 0211-1	UC X05-14	ASAHI	IB 0048-1	UC X10	ASAHI	IB 0190-1	UC X14-44	SLB	IB 0266-1
UC 311-35	SLB	IB 0222-1	UC X05-14S	NSK	IB 0048-1	UC X10	FYH	IB 0190-1	UC X14-44	ASAHI	IB 0266-1
UC 311-35S	NSK	IB 0222-1	UC X05-15	SLB	IB 0054-1	UC X10	NSK	IB 0190-1	UC X14-44	FYH	IB 0266-1
UC 312	SLB	IB 0235-1	UC X05-15	ASAHI	IB 0054-1	UC X10-29	SLB	IB 0174-1	UC X14-44S	NSK	IB 0266-1
UC 312	ASAHI	IB 0235-1	UC X05-15S	NSK	IB 0054-1	UC X10-29S	NSK	IB 0174-1	UC X15	SLB	IB 0286-1
UC 312	FYH	IB 0235-1	UC X05-16	SLB	IB 0067-1	UC X10-30	SLB	IB 0179-1	UC X15	ASAHI	IB 0286-1
UC 312	NSK	IB 0235-1	UC X05-16	ASAHI	IB 0067-1	UC X10-30	ASAHI	IB 0179-1	UC X15	FYH	IB 0286-1
UC 312-36	SLB	IB 0226-1	UC X05-16	FYH	IB 0067-1	UC X10-30S	NSK	IB 0179-1	UC X15	NSK	IB 0286-1
UC 312-36	ASAHI	IB 0226-1	UC X05-16S	NSK	IB 0067-1	UC X10-31	SLB	IB 0184-1	UC X15-45	SLB	IB 0274-1
UC 312-36S	NSK	IB 0226-1	UC X06	SLB	IB 0086-1	UC X10-31	ASAHI	IB 0184-1	UC X15-45S	NSK	IB 0274-1
UC 312-37	SLB	IB 0230-1	UC X06	ASAHI	IB 0086-1	UC X10-31	FYH	IB 0184-1	UC X15-46	SLB	IB 0278-1
UC 312-37S	NSK	IB 0230-1	UC X06	FYH	IB 0086-1	UC X10-31S	NSK	IB 0184-1	UC X15-46S	NSK	IB 0278-1
UC 312-38	SLB	IB 0239-1	UC X06	NSK	IB 0086-1	UC X10-32	SLB	IB 0195-1	UC X15-47	SLB	IB 0282-1
UC 312-38	ASAHI	IB 0239-1	UC X06-17	SLB	IB 0073-1	UC X10-32	ASAHI	IB 0195-1	UC X15-47	ASAHI	IB 0282-1
UC 312-38S	NSK	IB 0239-1	UC X06-17S	NSK	IB 0073-1	UC X10-32	FYH	IB 0195-1	UC X15-47S	NSK	IB 0282-1
UC 312-39	SLB	IB 0243-1	UC X06-18	SLB	IB 0079-1	UC X10-32S	NSK	IB 0195-1	UC X15-48	SLB	IB 0290-1
UC 312-39S	NSK	IB 0243-1	UC X06-18	ASAHI	IB 0079-1	UC X11	SLB	IB 0216-1	UC X15-48	ASAHI	IB 0290-1
UC 313	SLB	IB 0251-1	UC X06-18S	NSK	IB 0079-1	UC X11	ASAHI	IB 0216-1	UC X15-48	FYH	IB 0290-1
UC 313	ASAHI	IB 0251-1	UC X06-19	SLB	IB 0092-1	UC X11	FYH	IB 0216-1	UC X15-48S	NSK	IB 0290-1
UC 313	FYH	IB 0251-1	UC X06-19	ASAHI	IB 0092-1	UC X11	NSK	IB 0216-1	UC X16	SLB	IB 0299-1
UC 313	NSK	IB 0251-1	UC X06-19	FYH	IB 0092-1	UC X11-32	SLB	IB 0200-1	UC X16	ASAHI	IB 0299-1
UC 313-40	SLB	IB 0247-1	UC X06-19S	NSK	IB 0092-1	UC X11-32S	NSK	IB 0200-1	UC X16	FYH	IB 0299-1
UC 313-40	ASAHI	IB 0247-1	UC X06-20	SLB	IB 0098-1	UC X11-33	SLB	IB 0205-1	UC X16	NSK	IB 0299-1
UC 313-40	FYH	IB 0247-1	UC X06-20	ASAHI	IB 0098-1	UC X11-33S	NSK	IB 0205-1	UC X16-49	SLB	IB 0293-1
UC 313-40S	NSK	IB 0247-1	UC X06-20	FYH	IB 0098-1	UC X11-34	SLB	IB 0210-1	UC X16-50	SLB	IB 0296-1
UC 313-41	SLB	IB 0255-1	UC X06-20S	NSK	IB 0098-1	UC X11-34	ASAHI	IB 0210-1	UC X16-50S	NSK	IB 0296-1
UC 314	SLB	IB 0271-1	UC X07	SLB	IB 0123-1	UC X11-34S	NSK	IB 0210-1	UC201-008D1	NTN	IB 0006-1
UC 314	ASAHI	IB 0271-1	UC X07	ASAHI	IB 0123-1	UC X11-35	SLB	IB 0221-1	UC201D1	NTN	IB 0002-1
UC 314	FYH	IB 0271-1	UC X07	FYH	IB 0123-1	UC X11-35	ASAHI	IB 0221-1	UC202-009D1	NTN	IB 0010-1
UC 314	NSK	IB 0271-1	UC X07	NSK	IB 0123-1	UC X11-35	FYH	IB 0221-1	UC202-010D1	NTN	IB 0018-1
UC 314-42	SLB	IB 0259-1	UC X07-20	SLB	IB 0104-1	UC X11-35S	NSK	IB 0221-1	UC202D1	NTN	IB 0014-1
UC 314-42S	NSK	IB 0259-1	UC X07-20S	NSK	IB 0104-1	UC X12	SLB	IB 0234-1	UC203-011D1	NTN	IB 0026-1
UC 314-43	SLB	IB 0263-1	UC X07-21	SLB	IB 0110-1	UC X12	ASAHI	IB 0234-1	UC203D1	NTN	IB 0022-1
UC 314-43S	NSK	IB 0263-1	UC X07-21S	NSK	IB 0110-1	UC X12	FYH	IB 0234-1	UC204-012D1	NTN	IB 0030-1
UC 314-44	SLB	IB 0267-1	UC X07-22	SLB	IB 0116-1	UC X12	NSK	IB 0234-1	UC204D1	NTN	IB 0034-1
UC 314-44	ASAHI	IB 0267-1	UC X07-22	ASAHI	IB 0116-1	UC X12-36	SLB	IB 0225-1	UC205-013D1	NTN	IB 0039-1
UC 314-44	FYH	IB 0267-1	UC X07-22	FYH	IB 0116-1	UC X12-36	ASAHI	IB 0225-1	UC205-014D1	NTN	IB 0045-1
UC 314-44S	NSK	IB 0267-1	UC X07-22S	NSK	IB 0116-1	UC X12-36	FYH	IB 0225-1	UC205-015D1	NTN	IB 0051-1
UC 315	SLB	IB 0287-1	UC X07-23	SLB	IB 0129-1	UC X12-36S	NSK	IB 0225-1	UC205-100D1	NTN	IB 0064-1
UC 315	ASAHI	IB 0287-1	UC X07-23	ASAHI	IB 0129-1	UC X12-37	SLB	IB 0229-1	UC205D1	NTN	IB 0057-1
UC 315	FYH	IB 0287-1	UC X07-23	FYH	IB 0129-1	UC X12-37S	NSK	IB 0229-1	UC206-101D1	NTN	IB 0070-1
UC 315	NSK	IB 0287-1	UC X07-23S	NSK	IB 0129-1	UC X12-38	SLB	IB 0238-1	UC206-102D1	NTN	IB 0076-1
UC 315-45	SLB	IB 0275-1	UC X08	SLB	IB 0148-1	UC X12-38	ASAHI	IB 0238-1	UC206-103D1	NTN	IB 0089-1
UC 315-45S	NSK	IB 0275-1	UC X08	ASAHI	IB 0148-1	UC X12-38	FYH	IB 0238-1	UC206-104D1	NTN	IB 0095-1
UC 315-46	SLB	IB 0279-1	UC X08	FYH	IB 0148-1	UC X12-38S	NSK	IB 0238-1	UC206D1	NTN	IB 0082-1
UC 315-46S	NSK	IB 0279-1	UC X08	NSK	IB 0148-1	UC X12-39	SLB	IB 0242-1	UC207-104D1	NTN	IB 0101-1

BY PART NUMBER

Part No.	Brand	Group No.	Part No.	Brand	Group No.	Part No.	Brand	Group No.	Part No.	Brand	Group No.
UC207-105D1	NTN	IB 0107-1	UC309-112D1	NTN	IB 0164-1	UCX14D1	NTN	IB 0270-1	UEL204-012D1W3	NTN	IB 0032-1
UC207-106D1	NTN	IB 0113-1	UC309D1	NTN	IB 0170-1	UCX15-213D1	NTN	IB 0274-1	UEL204D1W3	NTN	IB 0036-1
UC207-107D1	NTN	IB 0126-1	UC310-113D1	NTN	IB 0175-1	UCX15-214D1	NTN	IB 0278-1	UEL205-013D1W3	NTN	IB 0041-1
UC207D1	NTN	IB 0119-1	UC310-114D1	NTN	IB 0180-1	UCX15-215D1	NTN	IB 0282-1	UEL205-014D1W3	NTN	IB 0047-1
UC208-108D1	NTN	IB 0132-1	UC310-115D1	NTN	IB 0185-1	UCX15-300D1	NTN	IB 0290-1	UEL205-015D1W3	NTN	IB 0053-1
UC208-109D1	NTN	IB 0138-1	UC310D1	NTN	IB 0191-1	UCX15D1	NTN	IB 0286-1	UEL205-100D1W3	NTN	IB 0066-1
UC208D1	NTN	IB 0144-1	UC311-200D1	NTN	IB 0201-1	UCX16-301D1	NTN	IB 0293-1	UEL205D1W3	NTN	IB 0059-1
UC209-110D1	NTN	IB 0150-1	UC311-201D1	NTN	IB 0206-1	UCX16-302D1	NTN	IB 0296-1	UEL206-101D1W3	NTN	IB 0072-1
UC209-111D1	NTN	IB 0155-1	UC311-202D1	NTN	IB 0211-1	UCX16D1	NTN	IB 0299-1	UEL206-102D1W3	NTN	IB 0078-1
UC209-112D1	NTN	IB 0160-1	UC311-203D1	NTN	IB 0222-1	UEL 201	SLB	IB 0004-1	UEL206-103D1W3	NTN	IB 0091-1
UC209D1	NTN	IB 0165-1	UC311D1	NTN	IB 0217-1	UEL 201-8	SLB	IB 0008-1	UEL206-104D1W3	NTN	IB 0097-1
UC210-113D1	NTN	IB 0171-1	UC312-204D1	NTN	IB 0226-1	UEL 202	SLB	IB 0016-1	UEL206D1W3	NTN	IB 0084-1
UC210-114D1	NTN	IB 0176-1	UC312-205D1	NTN	IB 0230-1	UEL 202-10	SLB	IB 0020-1	UEL207-104D1W3	NTN	IB 0103-1
UC210-115D1	NTN	IB 0181-1	UC312-206D1	NTN	IB 0239-1	UEL 202-9	SLB	IB 0012-1	UEL207-105D1W3	NTN	IB 0109-1
UC210-200D1	NTN	IB 0192-1	UC312-207D1	NTN	IB 0243-1	UEL 203	SLB	IB 0024-1	UEL207-106D1W3	NTN	IB 0115-1
UC210D1	NTN	IB 0186-1	UC312D1	NTN	IB 0235-1	UEL 203-11	SLB	IB 0028-1	UEL207-107D1W3	NTN	IB 0128-1
UC211-200D1	NTN	IB 0197-1	UC313-208D1	NTN	IB 0247-1	UEL 204	SLB	IB 0036-1	UEL207D1W3	NTN	IB 0121-1
UC211-201D1	NTN	IB 0202-1	UC313-209D1	NTN	IB 0255-1	UEL 204-12	SLB	IB 0032-1	UEL208-108D1W3	NTN	IB 0134-1
UC211-202D1	NTN	IB 0207-1	UC313D1	NTN	IB 0251-1	UEL 205	SLB	IB 0059-1	UEL208-109D1W3	NTN	IB 0140-1
UC211-203D1	NTN	IB 0218-1	UC314-210D1	NTN	IB 0259-1	UEL 205-13	SLB	IB 0041-1	UEL208D1W3	NTN	IB 0146-1
UC211D1	NTN	IB 0212-1	UC314-211D1	NTN	IB 0263-1	UEL 205-14	SLB	IB 0047-1	UEL209-110D1W3	NTN	IB 0152-1
UC212-204D1	NTN	IB 0223-1	UC314-212D1	NTN	IB 0267-1	UEL 205-15	SLB	IB 0053-1	UEL209-111D1W3	NTN	IB 0157-1
UC212-205D1	NTN	IB 0227-1	UC314D1	NTN	IB 0271-1	UEL 205-16	SLB	IB 0066-1	UEL209-112D1W3	NTN	IB 0162-1
UC212-206D1	NTN	IB 0236-1	UC315-213D1	NTN	IB 0275-1	UEL 206	SLB	IB 0084-1	UEL209D1W3	NTN	IB 0167-1
UC212-207D1	NTN	IB 0240-1	UC315-214D1	NTN	IB 0279-1	UEL 206-17	SLB	IB 0072-1	UEL210-113D1W3	NTN	IB 0173-1
UC212D1	NTN	IB 0231-1	UC315-215D1	NTN	IB 0283-1	UEL 206-18	SLB	IB 0078-1	UEL210-114D1W3	NTN	IB 0178-1
UC213-208D1	NTN	IB 0244-1	UC315-300D1	NTN	IB 0291-1	UEL 206-19	SLB	IB 0091-1	UEL210-115D1W3	NTN	IB 0183-1
UC213-209D1	NTN	IB 0252-1	UC315D1	NTN	IB 0287-1	UEL 206-20	SLB	IB 0097-1	UEL210-200D1W3	NTN	IB 0194-1
UC213D1	NTN	IB 0248-1	UC316-301D1	NTN	IB 0294-1	UEL 207	SLB	IB 0121-1	UEL210D1W3	NTN	IB 0188-1
UC214-210D1	NTN	IB 0256-1	UC316-302D1	NTN	IB 0297-1	UEL 207-20	SLB	IB 0103-1	UEL211-200D1W3	NTN	IB 0199-1
UC214-211D1	NTN	IB 0260-1	UC316D1	NTN	IB 0300-1	UEL 207-21	SLB	IB 0109-1	UEL211-201D1W3	NTN	IB 0204-1
UC214-212D1	NTN	IB 0264-1	UCX05-013D1	NTN	IB 0042-1	UEL 207-22	SLB	IB 0115-1	UEL211-202D1W3	NTN	IB 0209-1
UC214D1	NTN	IB 0268-1	UCX05-014D1	NTN	IB 0048-1	UEL 207-23	SLB	IB 0128-1	UEL211-203D1W3	NTN	IB 0220-1
UC215-213D1	NTN	IB 0272-1	UCX05-015D1	NTN	IB 0054-1	UEL 208	SLB	IB 0146-1	UEL211D1W3	NTN	IB 0214-1
UC215-214D1	NTN	IB 0276-1	UCX05-100D1	NTN	IB 0067-1	UEL 208-24	SLB	IB 0134-1	UEL212-204D1W3	NTN	IB 0224-1
UC215-215D1	NTN	IB 0280-1	UCX05D1	NTN	IB 0061-1	UEL 208-25	SLB	IB 0140-1	UEL212-205D1W3	NTN	IB 0228-1
UC215-300D1	NTN	IB 0288-1	UCX06-101D1	NTN	IB 0073-1	UEL 209	SLB	IB 0167-1	UEL212-206D1W3	NTN	IB 0237-1
UC215D1	NTN	IB 0284-1	UCX06-102D1	NTN	IB 0079-1	UEL 209-26	SLB	IB 0152-1	UEL212-207D1W3	NTN	IB 0241-1
UC216-301D1	NTN	IB 0292-1	UCX06-103D1	NTN	IB 0092-1	UEL 209-27	SLB	IB 0157-1	UEL212D1W3	NTN	IB 0232-1
UC216-302D1	NTN	IB 0295-1	UCX06D1	NTN	IB 0086-1	UEL 209-28	SLB	IB 0162-1	UEL213-208D1W3	NTN	IB 0245-1
UC216-303D1	NTN	IB 0301-1	UCX07-105D1	NTN	IB 0110-1	UEL 210	SLB	IB 0188-1	UEL213-209D1W3	NTN	IB 0253-1
UC216D1	NTN	IB 0298-1	UCX07-106D1	NTN	IB 0116-1	UEL 210-29	SLB	IB 0173-1	UEL213D1W3	NTN	IB 0249-1
UC217-304D1	NTN	IB 0302-1	UCX07-107D1	NTN	IB 0129-1	UEL 210-30	SLB	IB 0178-1	UEL214-210D1W3	NTN	IB 0257-1
UC217-305D1	NTN	IB 0303-1	UCX07D1	NTN	IB 0123-1	UEL 210-31	SLB	IB 0183-1	UEL214-211D1W3	NTN	IB 0261-1
UC217-307D1	NTN	IB 0305-1	UCX08-108D1	NTN	IB 0135-1	UEL 210-32	SLB	IB 0194-1	UEL214-212D1W3	NTN	IB 0265-1
UC217D1	NTN	IB 0304-1	UCX08-109D1	NTN	IB 0141-1	UEL 211	SLB	IB 0214-1	UEL214D1W3	NTN	IB 0269-1
UC218-308D1	NTN	IB 0306-1	UCX08D1	NTN	IB 0148-1	UEL 211-32	SLB	IB 0199-1	UEL215-213D1W3	NTN	IB 0273-1
UC218D1	NTN	IB 0307-1	UCX09-110D1	NTN	IB 0153-1	UEL 211-33	SLB	IB 0204-1	UEL215-214D1W3	NTN	IB 0277-1
UC305-013D1	NTN	IB 0043-1	UCX09-111D1	NTN	IB 0158-1	UEL 211-34	SLB	IB 0209-1	UEL215-215D1W3	NTN	IB 0281-1
UC305-014D1	NTN	IB 0049-1	UCX09-112D1	NTN	IB 0163-1	UEL 211-35	SLB	IB 0220-1	UEL215-300D1W3	NTN	IB 0289-1
UC305-015D1	NTN	IB 0055-1	UCX09D1	NTN	IB 0169-1	UEL 212	SLB	IB 0232-1	UEL215D1W3	NTN	IB 0285-1
UC305-100D1	NTN	IB 0068-1	UCX10-114D1	NTN	IB 0179-1	UEL 212-36	SLB	IB 0224-1	UG 204 + ER	ASAHI	IB 0036-1
UC305D1	NTN	IB 0062-1	UCX10-115D1	NTN	IB 0184-1	UEL 212-37	SLB	IB 0228-1	UG 204 + ER	NACHI	IB 0036-1
UC306-101D1	NTN	IB 0074-1	UCX10D1	NTN	IB 0190-1	UEL 212-38	SLB	IB 0237-1	UG 204-12 + ER	ASAHI	IB 0032-1
UC306-102D1	NTN	IB 0080-1	UCX11-201D1	NTN	IB 0205-1	UEL 212-39	SLB	IB 0241-1	UG 204-12 + ER	NACHI	IB 0032-1
UC306-103D1	NTN	IB 0093-1	UCX11-202D1	NTN	IB 0210-1	UEL 213	SLB	IB 0249-1	UG 205 + ER	ASAHI	IB 0059-1
UC306D1	NTN	IB 0087-1	UCX11-203D1	NTN	IB 0221-1	UEL 213-40	SLB	IB 0245-1	UG 205 + ER	NACHI	IB 0059-1
UC307-104D1	NTN	IB 0105-1	UCX11D1	NTN	IB 0216-1	UEL 213-41	SLB	IB 0253-1	UG 205-14 + ER	ASAHI	IB 0047-1
UC307-105D1	NTN	IB 0111-1	UCX12-206D1	NTN	IB 0238-1	UEL 214	SLB	IB 0269-1	UG 205-14 + ER	NACHI	IB 0047-1
UC307-106D1	NTN	IB 0117-1	UCX12-207D1	NTN	IB 0242-1	UEL 214-42	SLB	IB 0257-1	UG 205-15 + ER	ASAHI	IB 0053-1
UC307-107D1	NTN	IB 0130-1	UCX12D1	NTN	IB 0234-1	UEL 214-43	SLB	IB 0261-1	UG 205-15 + ER	NACHI	IB 0053-1
UC307D1	NTN	IB 0124-1	UCX13-208D1	NTN	IB 0246-1	UEL 214-44	SLB	IB 0265-1	UG 205-16 + ER	ASAHI	IB 0066-1
UC308-108D1	NTN	IB 0136-1	UCX13-209D1	NTN	IB 0254-1	UEL 215	SLB	IB 0285-1	UG 205-16 + ER	NACHI	IB 0066-1
UC308-109D1	NTN	IB 0142-1	UCX13D1	NTN	IB 0250-1	UEL 215-45	SLB	IB 0273-1	UG 206 + ER	ASAHI	IB 0084-1
UC308D1	NTN	IB 0149-1	UCX14-210D1	NTN	IB 0258-1	UEL 215-46	SLB	IB 0277-1	UG 206 + ER	NACHI	IB 0084-1
UC309-110D1	NTN	IB 0154-1	UCX14-211D1	NTN	IB 0262-1	UEL 215-47	SLB	IB 0281-1	UG 206-18 + ER	ASAHI	IB 0078-1
UC309-111D1	NTN	IB 0159-1	UCX14-212D1	NTN	IB 0266-1	UEL 215-48	SLB	IB 0289-1	UG 206-18 + ER	NACHI	IB 0078-1

BY PART NUMBER

Part No.	Brand	Group No.	Part No.	Brand	Group No.	Part No.	Brand	Group No.	Part No.	Brand	Group No.
UG 206-19 + ER	ASAHI	IB 0091-1	UG2M30NL	LINK-BELT	IB 0082-1	V-19	SEALMASTER	IB 0088-1	VS-327	BROWNING	IB 0158-1
UG 206-19 + ER	NACHI	IB 0091-1	UG2M40NL	LINK-BELT	IB 0144-1	V-20	SEALMASTER	IB 0100-1	VS-328	BROWNING	IB 0163-1
UG 206-20 + ER	ASAHI	IB 0097-1	UG2M50NL	LINK-BELT	IB 0186-1	V-20R	SEALMASTER	IB 0094-1	VS-331	BROWNING	IB 0184-1
UG 206-20 + ER	NACHI	IB 0097-1	UG2M55NL	LINK-BELT	IB 0212-1	V-22	SEALMASTER	IB 0112-1	VS-332	BROWNING	IB 0195-1
UG 207 + ER	ASAHI	IB 0121-1	UG2M60NL	LINK-BELT	IB 0231-1	V-23	SEALMASTER	IB 0125-1	VS-332	BROWNING	IB 0197-1
UG 207 + ER	NACHI	IB 0121-1	UK 205	SLB	IB 0037-1	V-31E	SEALMASTER	IB 0182-1	VS-335	BROWNING	IB 0221-1
UG 207-20 + ER	ASAHI	IB 0103-1	UK 205	ASAHI	IB 0037-1	V-31RE	SEALMASTER	IB 0193-1	VS-336	BROWNING	IB 0223-1
UG 207-20 + ER	NACHI	IB 0103-1	UK 205	FYH	IB 0037-1	V-32E	SEALMASTER	IB 0198-1	VS-339	BROWNING	IB 0240-1
UG 207-21 + ER	ASAHI	IB 0109-1	UK 205	NACHI	IB 0037-1	V-35E	SEALMASTER	IB 0219-1	VS-343	BROWNING	IB 0262-1
UG 207-21 + ER	NACHI	IB 0109-1	UK 205	NSK	IB 0037-1	V-8E	SEALMASTER	IB 0007-1	VS-347	BROWNING	IB 0282-1
UG 207-22 + ER	ASAHI	IB 0115-1	UK 206	SLB	IB 0060-1	VE-108	BROWNING	IB 0007-1	VS-348	BROWNING	IB 0290-1
UG 207-22 + ER	NACHI	IB 0115-1	UK 206	ASAHI	IB 0060-1	VE-110	BROWNING	IB 0019-1	WG210UL	LINK-BELT	IB 0019-1
UG 207-23 + ER	ASAHI	IB 0128-1	UK 206	FYH	IB 0060-1	VE-114	BROWNING	IB 0046-1	WG211UL	LINK-BELT	IB 0027-1
UG 207-23 + ER	NACHI	IB 0128-1	UK 206	NACHI	IB 0060-1	VE-115	BROWNING	IB 0052-1	WG212UL	LINK-BELT	IB 0031-1
UG 208 + ER	ASAHI	IB 0146-1	UK 206	NSK	IB 0060-1	VE-116	BROWNING	IB 0065-1	WG214UL	LINK-BELT	IB 0046-1
UG 208 + ER	NACHI	IB 0146-1	UK 207	SLB	IB 0085-1	VE-212	BROWNING	IB 0032-1	WG215UL	LINK-BELT	IB 0052-1
UG 208-24 + ER	ASAHI	IB 0134-1	UK 207	ASAHI	IB 0085-1	VE-214	BROWNING	IB 0047-1	WG216UL	LINK-BELT	IB 0065-1
UG 208-24 + ER	NACHI	IB 0134-1	UK 207	FYH	IB 0085-1	VE-215	BROWNING	IB 0053-1	WG220EL	LINK-BELT	IB 0102-1
UG 208-25 + ER	ASAHI	IB 0140-1	UK 207	NACHI	IB 0085-1	VE-216	BROWNING	IB 0066-1	WG222EL	LINK-BELT	IB 0114-1
UG 208-25 + ER	NACHI	IB 0140-1	UK 207	NSK	IB 0085-1	VE-218	BROWNING	IB 0078-1	WG223EL	LINK-BELT	IB 0127-1
UG 209 + ER	ASAHI	IB 0167-1	UK 208	SLB	IB 0122-1	VE-219	BROWNING	IB 0091-1	WG226UL	LINK-BELT	IB 0151-1
UG 209 + ER	NACHI	IB 0167-1	UK 208	ASAHI	IB 0122-1	VE-220	BROWNING	IB 0103-1	WG227UL	LINK-BELT	IB 0156-1
UG 209-26 + ER	ASAHI	IB 0152-1	UK 208	FYH	IB 0122-1	VE-220S	BROWNING	IB 0097-1	WG228UL	LINK-BELT	IB 0161-1
UG 209-26 + ER	NACHI	IB 0152-1	UK 208	NACHI	IB 0122-1	VE-222	BROWNING	IB 0115-1	WG231UL	LINK-BELT	IB 0182-1
UG 209-27 + ER	ASAHI	IB 0157-1	UK 208	NSK	IB 0122-1	VE-223	BROWNING	IB 0128-1	WG2B08UL	LINK-BELT	IB 0007-1
UG 209-27 + ER	NACHI	IB 0157-1	UK 209	SLB	IB 0147-1	VE-224	BROWNING	IB 0134-1	WG2E32UL	LINK-BELT	IB 0193-1
UG 209-28 + ER	ASAHI	IB 0162-1	UK 209	ASAHI	IB 0147-1	VE-226	BROWNING	IB 0152-1	YAR 204	SKF	IB 0034-1
UG 209-28 + ER	NACHI	IB 0162-1	UK 209	FYH	IB 0147-1	VE-227	BROWNING	IB 0157-1	YAR 204-012	SKF	IB 0030-1
UG 210 + ER	ASAHI	IB 0188-1	UK 209	NACHI	IB 0147-1	VE-228	BROWNING	IB 0162-1	YAR 205	SKF	IB 0057-1
UG 210 + ER	NACHI	IB 0188-1	UK 209	NSK	IB 0147-1	VE-231	BROWNING	IB 0183-1	YAR 205-013	SKF	IB 0039-1
UG 210-30 + ER	ASAHI	IB 0178-1	UK 210	SLB	IB 0168-1	VE-232	BROWNING	IB 0199-1	YAR 205-014	SKF	IB 0045-1
UG 210-30 + ER	NACHI	IB 0178-1	UK 210	ASAHI	IB 0168-1	VE-235	BROWNING	IB 0220-1	YAR 205-015	SKF	IB 0051-1
UG 210-31 + ER	ASAHI	IB 0183-1	UK 210	FYH	IB 0168-1	VE-236	BROWNING	IB 0224-1	YAR 205-100	SKF	IB 0064-1
UG 210-31 + ER	NACHI	IB 0183-1	UK 210	NACHI	IB 0168-1	VE-239	BROWNING	IB 0241-1	YAR 206	SKF	IB 0082-1
UG 211 + ER	ASAHI	IB 0214-1	UK 210	NSK	IB 0168-1	VE-243	BROWNING	IB 0261-1	YAR 206-101	SKF	IB 0070-1
UG 211 + ER	NACHI	IB 0214-1	UK 211	SLB	IB 0189-1	VE-247	BROWNING	IB 0281-1	YAR 206-102	SKF	IB 0076-1
UG 211-32 + ER	ASAHI	IB 0199-1	UK 211	ASAHI	IB 0189-1	VS-114	BROWNING	IB 0044-1	YAR 206-103	SKF	IB 0089-1
UG 211-32 + ER	NACHI	IB 0199-1	UK 211	FYH	IB 0189-1	VS-115	BROWNING	IB 0050-1	YAR 206-104	SKF	IB 0095-1
UG 211-34 + ER	ASAHI	IB 0209-1	UK 211	NACHI	IB 0189-1	VS-116	BROWNING	IB 0063-1	YAR 207	SKF	IB 0119-1
UG 211-34 + ER	NACHI	IB 0209-1	UK 211	NSK	IB 0189-1	VS-118	BROWNING	IB 0075-1	YAR 207-104	SKF	IB 0098-1
UG 211-35 + ER	ASAHI	IB 0220-1	UK 212	SLB	IB 0215-1	VS-119	BROWNING	IB 0088-1	YAR 207-104	SKF	IB 0101-1
UG 211-35 + ER	NACHI	IB 0220-1	UK 212	ASAHI	IB 0215-1	VS-120S	BROWNING	IB 0094-1	YAR 207-105	SKF	IB 0107-1
UG 212 + ER	ASAHI	IB 0232-1	UK 212	FYH	IB 0215-1	VS-122	BROWNING	IB 0112-1	YAR 207-106	SKF	IB 0113-1
UG 212 + ER	NACHI	IB 0232-1	UK 212	NACHI	IB 0215-1	VS-123	BROWNING	IB 0125-1	YAR 207-107	SKF	IB 0126-1
UG 212-36 + ER	ASAHI	IB 0224-1	UK 212	NSK	IB 0215-1	VS-212	BROWNING	IB 0030-1	YAR 208	SKF	IB 0144-1
UG 212-36 + ER	NACHI	IB 0224-1	UK 213	SLB	IB 0233-1	VS-214	BROWNING	IB 0045-1	YAR 208-107	SKF	IB 0129-1
UG 212-38 + ER	ASAHI	IB 0237-1	UK 213	ASAHI	IB 0233-1	VS-215	BROWNING	IB 0051-1	YAR 208-108	SKF	IB 0132-1
UG 212-38 + ER	NACHI	IB 0237-1	UK 213	FYH	IB 0233-1	VS-216	BROWNING	IB 0064-1	YAR 208-109	SKF	IB 0138-1
UG 212-39 + ER	ASAHI	IB 0241-1	UK 213	NACHI	IB 0233-1	VS-218	BROWNING	IB 0076-1	YAR 209	SKF	IB 0165-1
UG 212-39 + ER	NACHI	IB 0241-1	UK 213	NSK	IB 0233-1	VS-219	BROWNING	IB 0089-1	YAR 209-108	SKF	IB 0135-1
UG212NL	LINK-BELT	IB 0030-1	UK205D1	NTN	IB 0037-1	VS-220S	BROWNING	IB 0095-1	YAR 209-110	SKF	IB 0150-1
UG214NL	LINK-BELT	IB 0045-1	UK206D1	NTN	IB 0060-1	VS-222	BROWNING	IB 0113-1	YAR 209-111	SKF	IB 0155-1
UG215NL	LINK-BELT	IB 0051-1	UK207D1	NTN	IB 0085-1	VS-223	BROWNING	IB 0126-1	YAR 209-112	SKF	IB 0160-1
UG216NL	LINK-BELT	IB 0064-1	UK208D1	NTN	IB 0122-1	VS-224	BROWNING	IB 0132-1	YAR 210	SKF	IB 0186-1
UG218NL	LINK-BELT	IB 0076-1	UK209D1	NTN	IB 0147-1	VS-226	BROWNING	IB 0150-1	YAR 210-111	SKF	IB 0158-1
UG219NL	LINK-BELT	IB 0089-1	UK210D1	NTN	IB 0168-1	VS-227	BROWNING	IB 0155-1	YAR 210-112	SKF	IB 0163-1
UG224NL	LINK-BELT	IB 0132-1	UK211D1	NTN	IB 0189-1	VS-228	BROWNING	IB 0160-1	YAR 210-114	SKF	IB 0176-1
UG231NL	LINK-BELT	IB 0181-1	UK212D1	NTN	IB 0215-1	VS-231	BROWNING	IB 0181-1	YAR 210-115	SKF	IB 0181-1
UG232NL	LINK-BELT	IB 0197-1	UK213D1	NTN	IB 0233-1	VS-232S	BROWNING	IB 0192-1	YAR 211	SKF	IB 0212-1
UG235NL	LINK-BELT	IB 0218-1	V-10E	SEALMASTER	IB 0019-1	VS-235	BROWNING	IB 0218-1	YAR 211-115	SKF	IB 0184-1
UG236NL	LINK-BELT	IB 0223-1	V-14	SEALMASTER	IB 0044-1	VS-247	BROWNING	IB 0280-1	YAR 211-200	SKF	IB 0197-1
UG238NL	LINK-BELT	IB 0236-1	V-14E	SEALMASTER	IB 0046-1	VS-316	BROWNING	IB 0067-1	YAR 211-203	SKF	IB 0218-1
UG239NL	LINK-BELT	IB 0240-1	V-15	SEALMASTER	IB 0050-1	VS-319	BROWNING	IB 0092-1	YAR 212	SKF	IB 0231-1
UG2E20NL	LINK-BELT	IB 0095-1	V-15E	SEALMASTER	IB 0052-1	VS-320	BROWNING	IB 0098-1	YAR 212-203	SKF	IB 0221-1
UG2E32NL	LINK-BELT	IB 0192-1	V-16	SEALMASTER	IB 0063-1	VS-320	BROWNING	IB 0101-1	YAR 212-204	SKF	IB 0223-1
UG2M20NL	LINK-BELT	IB 0034-1	V-16E	SEALMASTER	IB 0065-1	VS-323	BROWNING	IB 0129-1	YAR 212-207	SKF	IB 0240-1
UG2M25NL	LINK-BELT	IB 0057-1	V-18	SEALMASTER	IB 0075-1	VS-324	BROWNING	IB 0135-1	YAR 213	SKF	IB 0248-1

BY PART NUMBER

Part No.	Brand	Group No.	Part No.	Brand	Group No.
YAR 213-208	SKF	IB 0244-1	YET 207-107	SKF	IB 0127-1
YAR 214	SKF	IB 0268-1	YET 208	SKF	IB 0145-1
YAR 214-208	SKF	IB 0246-1	YET 208-108	SKF	IB 0133-1
YAR 215	SKF	IB 0284-1	YET 208-109	SKF	IB 0139-1
YAR 215-211	SKF	IB 0262-1	YET 209	SKF	IB 0166-1
YAR 215-215	SKF	IB 0280-1	YET 209-110	SKF	IB 0151-1
YAR 216	SKF	IB 0298-1	YET 209-111	SKF	IB 0156-1
YAR 216-215	SKF	IB 0282-1	YET 209-112	SKF	IB 0161-1
YAR 216-300	SKF	IB 0290-1	YET 210	SKF	IB 0187-1
YAR 217	SKF	IB 0304-1	YET 210-114	SKF	IB 0177-1
YAR 218	SKF	IB 0307-1	YET 210-115	SKF	IB 0182-1
YAR 218-308	SKF	IB 0306-1	YET 211	SKF	IB 0213-1
YEL 204	SKF	IB 0036-1	YET 211-200	SKF	IB 0198-1
YEL 204-012	SKF	IB 0032-1	YET 211-203	SKF	IB 0219-1
YEL 205	SKF	IB 0059-1	YG212NL	LINK-BELT	IB 0032-1
YEL 205-013	SKF	IB 0041-1	YG214NL	LINK-BELT	IB 0047-1
YEL 205-014	SKF	IB 0047-1	YG215NL	LINK-BELT	IB 0053-1
YEL 205-015	SKF	IB 0053-1	YG216NL	LINK-BELT	IB 0059-1
YEL 205-100	SKF	IB 0066-1	YG218NL	LINK-BELT	IB 0078-1
YEL 206	SKF	IB 0084-1	YG219NL	LINK-BELT	IB 0091-1
YEL 206-101	SKF	IB 0072-1	YG220NL	LINK-BELT	IB 0103-1
YEL 206-102	SKF	IB 0078-1	YG222NL	LINK-BELT	IB 0115-1
YEL 206-103	SKF	IB 0091-1	YG223NL	LINK-BELT	IB 0128-1
YEL 206-104	SKF	IB 0097-1	YG224NL	LINK-BELT	IB 0134-1
YEL 207	SKF	IB 0121-1	YG226NL	LINK-BELT	IB 0152-1
YEL 207-104	SKF	IB 0103-1	YG227NL	LINK-BELT	IB 0157-1
YEL 207-105	SKF	IB 0109-1	YG228NL	LINK-BELT	IB 0162-1
YEL 207-106	SKF	IB 0115-1	YG231NL	LINK-BELT	IB 0183-1
YEL 207-107	SKF	IB 0128-1	YG232NL	LINK-BELT	IB 0199-1
YEL 208	SKF	IB 0146-1	YG235NL	LINK-BELT	IB 0220-1
YEL 208-108	SKF	IB 0134-1	YG236NL	LINK-BELT	IB 0224-1
YEL 208-109	SKF	IB 0140-1	YG238NL	LINK-BELT	IB 0237-1
YEL 209	SKF	IB 0167-1	YG239NL	LINK-BELT	IB 0241-1
YEL 209-110	SKF	IB 0152-1	YG2E20NL	LINK-BELT	IB 0097-1
YEL 209-111	SKF	IB 0157-1	YG2E32NL	LINK-BELT	IB 0194-1
YEL 209-112	SKF	IB 0162-1			
YEL 210	SKF	IB 0188-1			
YEL 210-114	SKF	IB 0178-1			
YEL 210-115	SKF	IB 0183-1			
YEL 211	SKF	IB 0214-1			
YEL 211-200	SKF	IB 0199-1			
YEL 211-203	SKF	IB 0220-1			
YEL 212	SKF	IB 0232-1			
YEL 212-204	SKF	IB 0224-1			
YEL 212-207	SKF	IB 0241-1			
YET 203	SKF	IB 0023-1			
YET 203/12	SKF	IB 0003-1			
YET 203/15	SKF	IB 0015-1			
YET 203-008	SKF	IB 0007-1			
YET 203-010	SKF	IB 0019-1			
YET 203-011	SKF	IB 0027-1			
YET 204	SKF	IB 0035-1			
YET 204-012	SKF	IB 0031-1			
YET 205	SKF	IB 0058-1			
YET 205-013	SKF	IB 0040-1			
YET 205-014	SKF	IB 0046-1			
YET 205-015	SKF	IB 0052-1			
YET 205-100	SKF	IB 0065-1			
YET 206	SKF	IB 0083-1			
YET 206-101	SKF	IB 0071-1			
YET 206-102	SKF	IB 0077-1			
YET 206-103	SKF	IB 0090-1			
YET 206-104	SKF	IB 0096-1			
YET 207	SKF	IB 0120-1			
YET 207-104	SKF	IB 0102-1			
YET 207-105	SKF	IB 0108-1			
YET 207-106	SKF	IB 0114-1			

FIGURE NUMBER

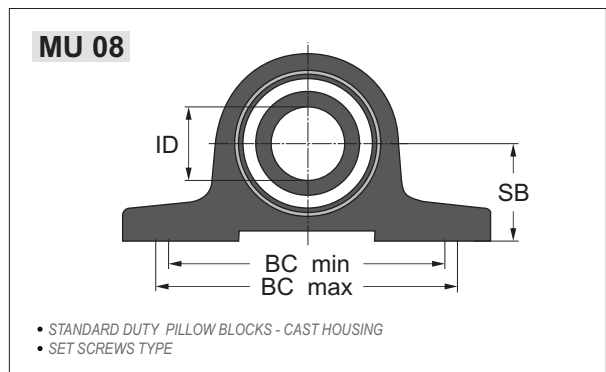
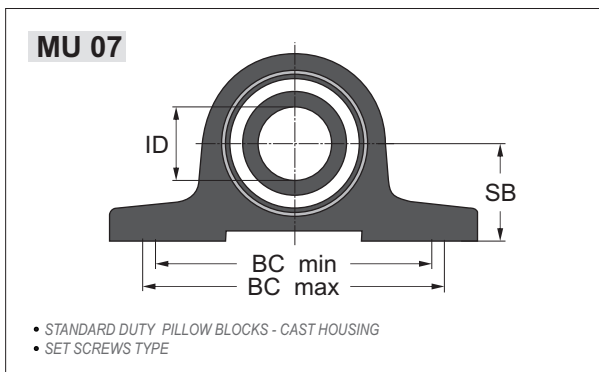
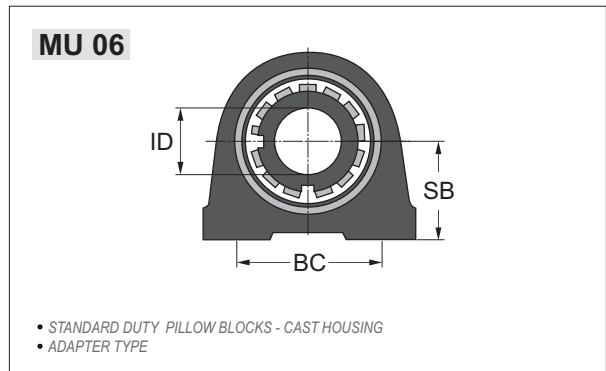
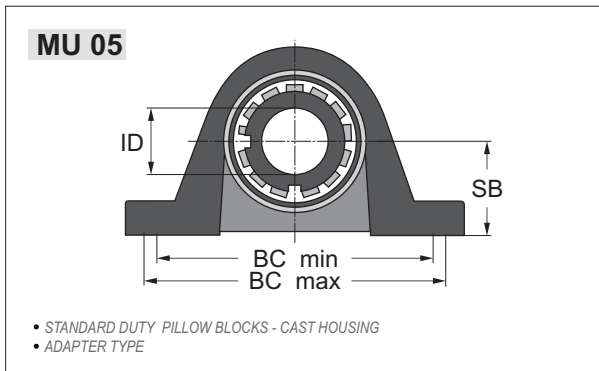
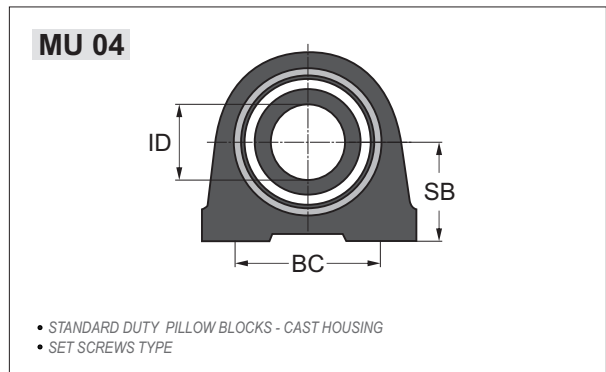
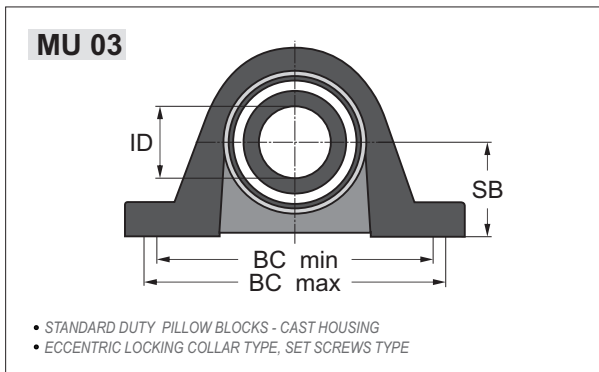
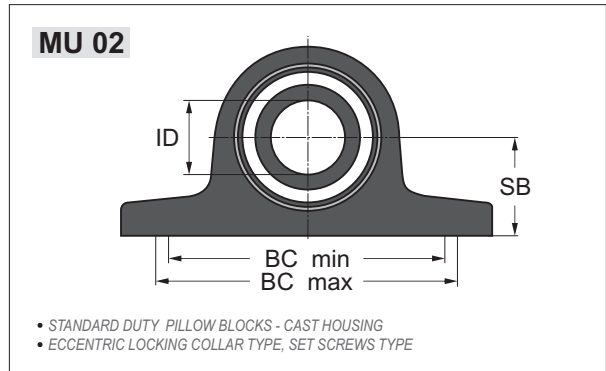
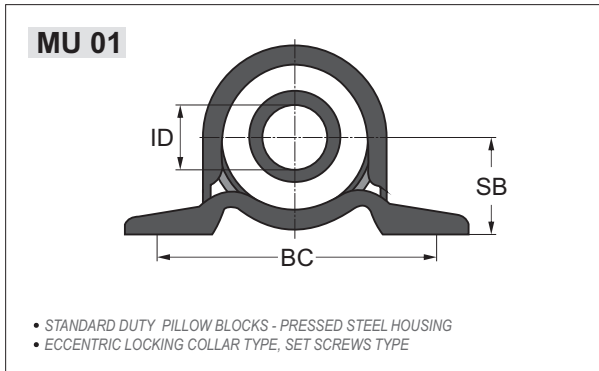

MU 09

- STANDARD DUTY TWO BOLTS FLANGED UNITS - PRESSED STEEL HOUSING
- ECCENTRIC LOCKING COLLAR TYPE, SET SCREWS TYPE

MU 10

- STANDARD DUTY FLANGED CARTRIDGE UNITS - PRESSED STEEL HOUSING
- ECCENTRIC LOCKING COLLAR TYPE, SET SCREWS TYPE

MU 11

- STANDARD DUTY FLANGED UNITS - CAST HOUSING
- ECCENTRIC LOCKING COLLAR TYPE, SET SCREWS TYPE

MU 12

- STANDARD DUTY FLANGED UNITS - CAST HOUSING
- ECCENTRIC LOCKING COLLAR TYPE, SET SCREWS TYPE

MU 13

- STANDARD DUTY FLANGED CARTRIDGE UNITS - CAST HOUSING
- ECCENTRIC LOCKING COLLAR TYPE, SET SCREWS TYPE

MU 14

- STANDARD DUTY TWO BOLTS FLANGED UNITS - CAST HOUSING
- ECCENTRIC LOCKING COLLAR TYPE, SET SCREWS TYPE

MU 15

- STANDARD DUTY TWO BOLTS FLANGED UNITS - CAST HOUSING
- ECCENTRIC LOCKING COLLAR TYPE, SET SCREWS TYPE

MU 16

- STANDARD DUTY FLANGED UNITS - CAST HOUSING
- ADAPTER TYPE

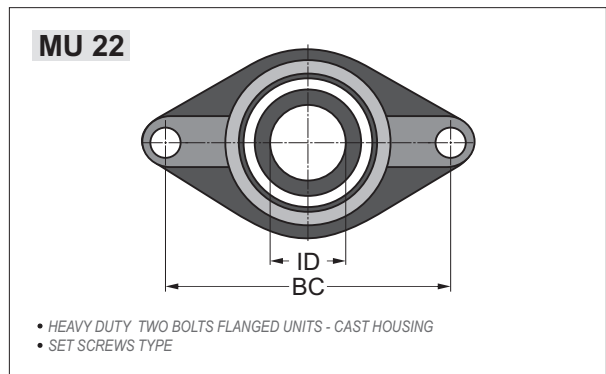
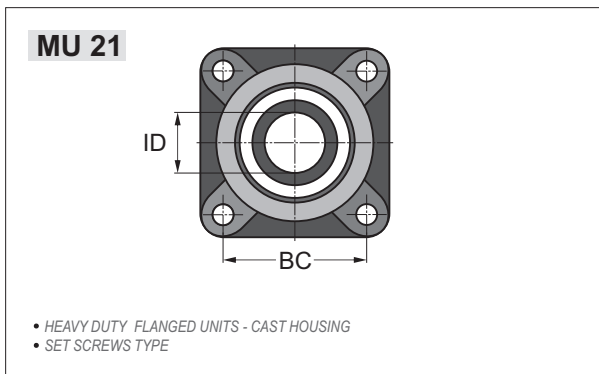
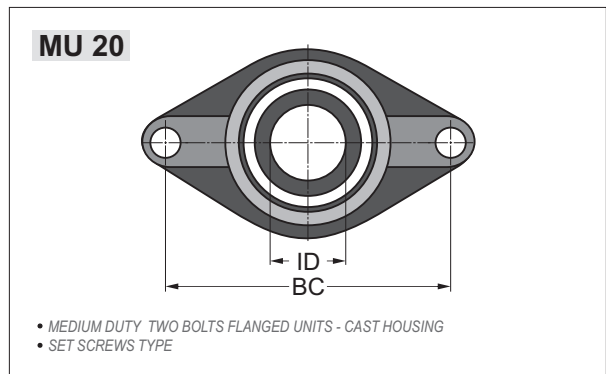
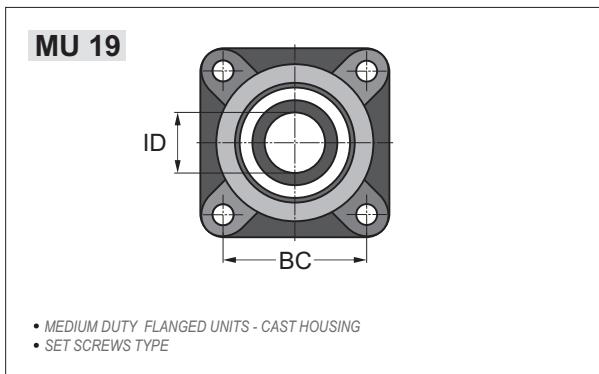
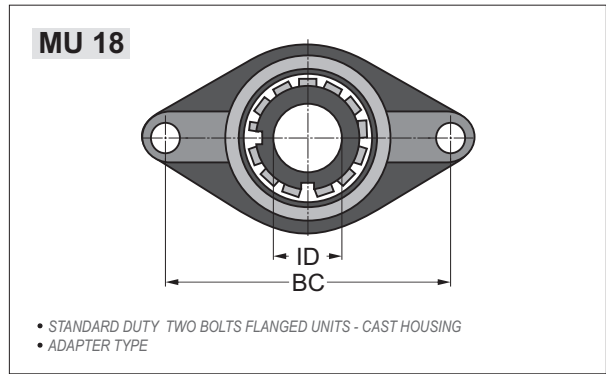
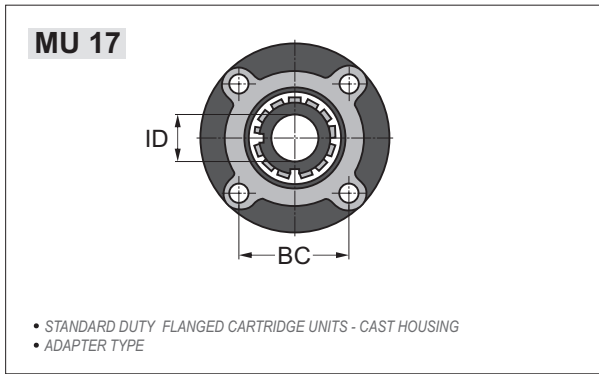

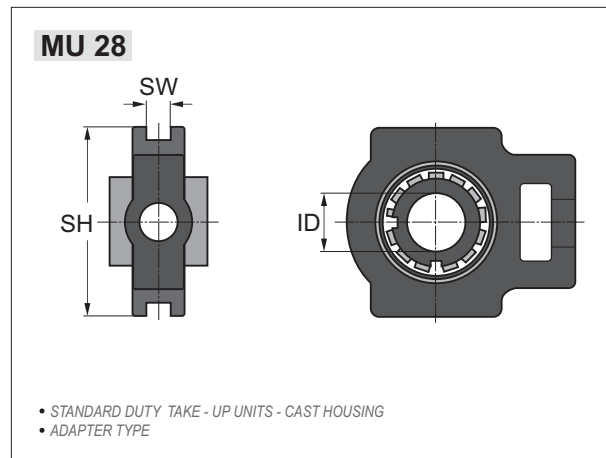
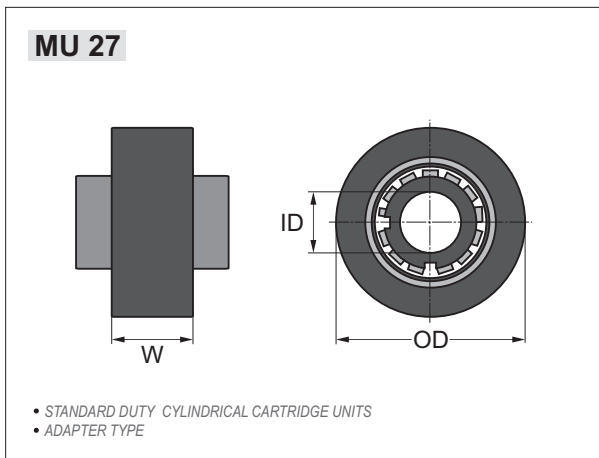
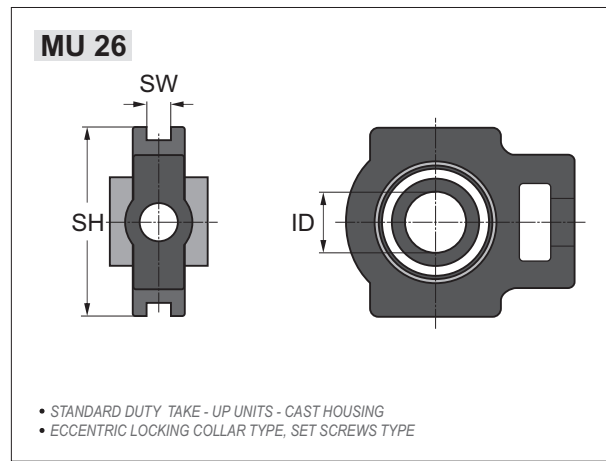
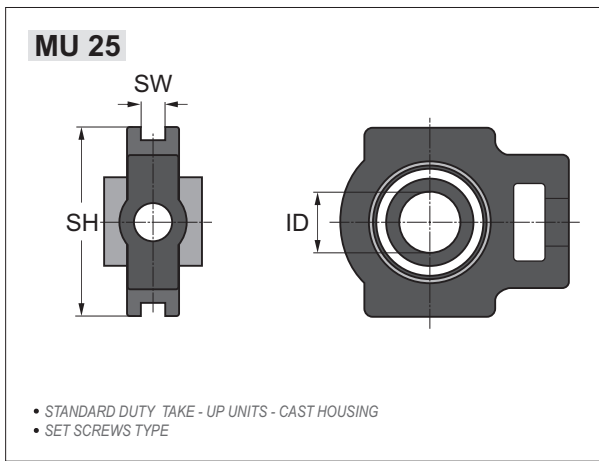
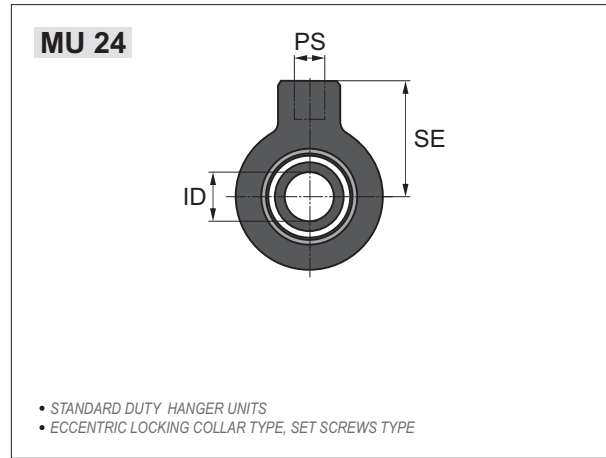
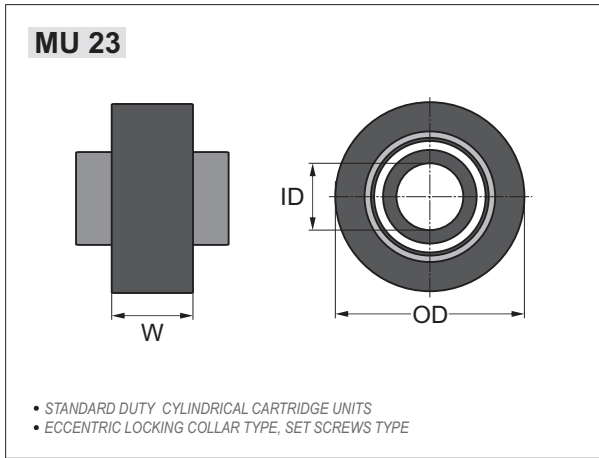

MU 29

• STANDARD DUTY SPHERICAL OUTSIDE SURFACE BALL BEARINGS
• ECCENTRIC LOCKING COLLAR TYPE

MU 30

• STANDARD DUTY SPHERICAL OUTSIDE SURFACE BALL BEARINGS
• SET SCREWS TYPE

MU 31

• STANDARD DUTY SPHERICAL OUTSIDE SURFACE BALL BEARINGS
• SET SCREWS TYPE

MU 32

• HEAVY DUTY SPHERICAL OUTSIDE SURFACE BALL BEARINGS
• SET SCREWS TYPE

MU 33

• MEDIUM DUTY SPHERICAL OUTSIDE SURFACE BALL BEARINGS
• SET SCREWS TYPE

MU 34

• STANDARD DUTY SPHERICAL OUTSIDE SURFACE BALL BEARINGS
• ECCENTRIC LOCKING COLLAR TYPE

MU 35

• STANDARD DUTY SPHERICAL OUTSIDE SURFACE BALL BEARINGS
• ADAPTER TYPE

FIGURE NUMBER



DIMENSIONS

PILLOW BLOCKS **DIMENSIONS**

HYC	Number	ID		SB		Graphic	Figure No.	Group No.
		in	mm	in	mm			
SAPP	201	0.4724	12.00	0.8740	22.20		MU 01	PB 0001 - 1
SBPP	201	0.4724	12.00	0.8740	22.20		MU 01	PB 0001 - 2
UCP	201	0.4724	12.00	1.1890	30.20		MU 03	PB 0002 - 1
UELP	201	0.4724	12.00	1.1890	30.20		MU 03	PB 0002 - 2
UCPA	201	0.4724	12.00	1.1890	30.20		MU 04	PB 0003 - 1
SAPP	201 - 8	0.5000	12.70	0.8740	22.20		MU 01	PB 0004 - 1
SBPP	201 - 8	0.5000	12.70	0.8740	22.20		MU 01	PB 0004 - 2
UCP	201 - 8	0.5000	12.70	1.1890	30.20		MU 03	PB 0005 - 1
UELP	201 - 8	0.5000	12.70	1.1890	30.20		MU 03	PB 0005 - 2
UCPA	201 - 8	0.5000	12.70	1.1890	30.20		MU 04	PB 0006 - 1
SAPP	202 - 9	0.5625	14.29	0.8740	22.20		MU 01	PB 0007 - 1
SBPP	202 - 9	0.5625	14.29	0.8740	22.20		MU 01	PB 0007 - 2
UCP	202 - 9	0.5625	14.29	1.1890	30.20		MU 03	PB 0008 - 1
UCPA	202 - 9	0.5625	14.29	1.1890	30.20		MU 04	PB 0009 - 1
SAPP	202	0.5906	15.00	0.8740	22.20		MU 01	PB 0010 - 1
SBPP	202	0.5906	15.00	0.8740	22.20		MU 01	PB 0010 - 2
UCP	202	0.5906	15.00	1.1890	30.20		MU 03	PB 0011 - 1
UELP	202	0.5906	15.00	1.1890	30.20		MU 03	PB 0011 - 2
UCPA	202	0.5906	15.00	1.1890	30.20		MU 04	PB 0012 - 1
SAPP	202 - 10	0.6250	15.88	0.8740	22.20		MU 01	PB 0013 - 1
SBPP	202 - 10	0.6250	15.88	0.8740	22.20		MU 01	PB 0013 - 2
UCP	202 - 10	0.6250	15.88	1.1890	30.20		MU 03	PB 0014 - 1
UELP	202 - 10	0.6250	15.88	1.1890	30.20		MU 03	PB 0014 - 2
UCPA	202 - 10	0.6250	15.88	1.1890	30.20		MU 04	PB 0015 - 1
SAPP	203	0.6693	17.00	0.8740	22.20		MU 01	PB 0016 - 1
SBPP	203	0.6693	17.00	0.8740	22.20		MU 01	PB 0016 - 2
UCP	203	0.6693	17.00	1.1890	30.20		MU 03	PB 0017 - 1
UELP	203	0.6693	17.00	1.1890	30.20		MU 03	PB 0017 - 2
UCPA	203	0.6693	17.00	1.1890	30.20		MU 04	PB 0018 - 1
SAPP	203 - 11	0.6875	17.46	0.8740	22.20		MU 01	PB 0019 - 1
SBPP	203 - 11	0.6875	17.46	0.8740	22.20		MU 01	PB 0019 - 2
UCP	203 - 11	0.6875	17.46	1.1890	30.20		MU 03	PB 0020 - 1
UELP	203 - 11	0.6875	17.46	1.1890	30.20		MU 03	PB 0020 - 2
UCPA	203 - 11	0.6875	17.46	1.1890	30.20		MU 04	PB 0021 - 1
SAPP	204 - 12	0.7500	19.05	1.0000	25.40		MU 01	PB 0022 - 1
SBPP	204 - 12	0.7500	19.05	1.0000	25.40		MU 01	PB 0022 - 2
UCPA	204 - 12	0.7500	19.05	1.1890	30.20		MU 04	PB 0023 - 1
UCAK	204 - 12	0.7500	19.05	1.2520	31.80		MU 02	PB 0024 - 1
UELAK	204 - 12	0.7500	19.05	1.2520	31.80		MU 02	PB 0024 - 2
SAAK	204 - 12	0.7500	19.05	1.2520	31.80		MU 02	PB 0024 - 3
SBAK	204 - 12	0.7500	19.05	1.2520	31.80		MU 02	PB 0024 - 4
UCP	204 - 12	0.7500	19.05	1.3110	33.30		MU 03	PB 0025 - 1











































DIMENSIONS

PILLOW BLOCKS DIMENSIONS

HYC Number	ID		SB		Graphic	Figure No.	Group No.
	in	mm	in	mm			
UELP 204 - 12	0.7500	19.05	1.3110	33.30		MU 03	PB 0025 - 2
SAP 204 - 12	0.7500	19.05	1.3110	33.30		MU 03	PB 0025 - 3
SBP 204 - 12	0.7500	19.05	1.3110	33.30		MU 03	PB 0025 - 4
SAPP 204	0.7874	20.00	1.0000	25.40		MU 01	PB 0026 - 1
SBPP 204	0.7874	20.00	1.0000	25.40		MU 01	PB 0026 - 2
UCPA 204	0.7874	20.00	1.1890	30.20		MU 04	PB 0027 - 1
UCAK 204	0.7874	20.00	1.2520	31.80		MU 02	PB 0028 - 1
UELAK 204	0.7874	20.00	1.2520	31.80		MU 02	PB 0028 - 2
SAAK 204	0.7874	20.00	1.2520	31.80		MU 02	PB 0028 - 3
SBAK 204	0.7874	20.00	1.2520	31.80		MU 02	PB 0028 - 4
UCP 204	0.7874	20.00	1.3110	33.30		MU 03	PB 0029 - 1
UELP 204	0.7874	20.00	1.3110	33.30		MU 03	PB 0029 - 2
SAP 204	0.7874	20.00	1.3110	33.30		MU 03	PB 0029 - 3
SBP 204	0.7874	20.00	1.3110	33.30		MU 03	PB 0029 - 4
UKP 205	0.7874	20.00	1.4370	36.50		MU 05	PB 0030 - 1
UKPA 205	0.7874	20.00	1.4370	36.50		MU 06	PB 0031 - 1
SAPP 205 - 13	0.8125	20.64	1.1260	28.60		MU 01	PB 0032 - 1
SBPP 205 - 13	0.8125	20.64	1.1260	28.60		MU 01	PB 0032 - 2
UCAK 205 - 13	0.8125	20.64	1.3110	33.30		MU 02	PB 0033 - 1
UELAK 205 - 13	0.8125	20.64	1.3110	33.30		MU 02	PB 0033 - 2
SAAK 205 - 13	0.8125	20.64	1.3110	33.30		MU 02	PB 0033 - 3
SBAK 205 - 13	0.8125	20.64	1.3110	33.30		MU 02	PB 0033 - 4
UCP 205 - 13	0.8125	20.64	1.4370	36.50		MU 03	PB 0034 - 1
UELP 205 - 13	0.8125	20.64	1.4370	36.50		MU 03	PB 0034 - 2
SAP 205 - 13	0.8125	20.64	1.4370	36.50		MU 03	PB 0034 - 3
UCPA 205 - 13	0.8125	20.64	1.4370	36.50		MU 04	PB 0035 - 1
UCP X05 - 13	0.8125	20.64	1.7480	44.40		MU 07	PB 0036 - 1
UCP 305 - 13	0.8125	20.64	1.7717	45.00		MU 08	PB 0037 - 1
SAPP 205 - 14	0.8750	22.23	1.1260	28.60		MU 01	PB 0038 - 1
SBPP 205 - 14	0.8750	22.23	1.1260	28.60		MU 01	PB 0038 - 2
UCAK 205 - 14	0.8750	22.23	1.3110	33.30		MU 02	PB 0039 - 1
UELAK 205 - 14	0.8750	22.23	1.3110	33.30		MU 02	PB 0039 - 2
SAAK 205 - 14	0.8750	22.23	1.3110	33.30		MU 02	PB 0039 - 3
SBAK 205 - 14	0.8750	22.23	1.3110	33.30		MU 02	PB 0039 - 4
UCP 205 - 14	0.8750	22.23	1.4370	36.50		MU 03	PB 0040 - 1
UELP 205 - 14	0.8750	22.23	1.4370	36.50		MU 03	PB 0040 - 2
SAP 205 - 14	0.8750	22.23	1.4370	36.50		MU 03	PB 0040 - 3
SBP 205 - 14	0.8750	22.23	1.4370	36.50		MU 03	PB 0040 - 4
UCPA 205 - 14	0.8750	22.23	1.4370	36.50		MU 04	PB 0041 - 1
UCP X05 - 14	0.8750	22.23	1.7480	44.40		MU 07	PB 0042 - 1
UCP 305 - 14	0.8750	22.23	1.7717	45.00		MU 08	PB 0043 - 1
SAPP 205 - 15	0.9375	23.81	1.1260	28.60		MU 01	PB 0044 - 1











































PILLOW BLOCKS

DIMENSIONS

HYC	Number	ID		SB		Graphic	Figure No.	Group No.
		in	mm	in	mm			
SBPP	205 - 15	0.9375	23.81	1.1260	28.60		MU 01	PB 0044 - 2
UCAK	205 - 15	0.9375	23.81	1.3110	33.30		MU 02	PB 0045 - 1
UELAK	205 - 15	0.9375	23.81	1.3110	33.30		MU 02	PB 0045 - 2
SAAK	205 - 15	0.9375	23.81	1.3110	33.30		MU 02	PB 0045 - 3
SBAK	205 - 15	0.9375	23.81	1.3110	33.30		MU 02	PB 0045 - 4
UCP	205 - 15	0.9375	23.81	1.4370	36.50		MU 03	PB 0046 - 1
UELP	205 - 15	0.9375	23.81	1.4370	36.50		MU 03	PB 0046 - 2
SAP	205 - 15	0.9375	23.81	1.4370	36.50		MU 03	PB 0046 - 3
SBP	205 - 15	0.9375	23.81	1.4370	36.50		MU 03	PB 0046 - 4
UCPA	205 - 15	0.9375	23.81	1.4370	36.50		MU 04	PB 0047 - 1
UCP X05	205 - 15	0.9375	23.81	1.7480	44.40		MU 07	PB 0048 - 1
UCP 305	205 - 15	0.9375	23.81	1.7717	45.00		MU 08	PB 0049 - 1
SAPP	205	0.9843	25.00	1.1260	28.60		MU 01	PB 0050 - 1
SBPP	205	0.9843	25.00	1.1260	28.60		MU 01	PB 0050 - 2
UCAK	205	0.9843	25.00	1.3110	33.30		MU 02	PB 0051 - 1
UELAK	205	0.9843	25.00	1.3110	33.30		MU 02	PB 0051 - 2
SAAK	205	0.9843	25.00	1.3110	33.30		MU 02	PB 0051 - 3
SBAK	205	0.9843	25.00	1.3110	33.30		MU 02	PB 0051 - 4
UCP	205	0.9843	25.00	1.4370	36.50		MU 03	PB 0052 - 1
UELP	205	0.9843	25.00	1.4370	36.50		MU 03	PB 0052 - 2
SAP	205	0.9843	25.00	1.4370	36.50		MU 03	PB 0052 - 3
SBP	205	0.9843	25.00	1.4370	36.50		MU 03	PB 0052 - 4
UCPA	205	0.9843	25.00	1.4370	36.50		MU 04	PB 0053 - 1
UKP	206	0.9843	25.00	1.6890	42.90		MU 05	PB 0054 - 1
UKPA	206	0.9843	25.00	1.6890	42.90		MU 06	PB 0055 - 1
UCP X05	205	0.9843	25.00	1.7480	44.40		MU 07	PB 0056 - 1
UCP 305	205	0.9843	25.00	1.7717	45.00		MU 08	PB 0057 - 1
SAPP	205 - 16	1.0000	25.40	1.1260	28.60		MU 01	PB 0058 - 1
SBPP	205 - 16	1.0000	25.40	1.1260	28.60		MU 01	PB 0058 - 2
UCAK	205 - 16	1.0000	25.40	1.3110	33.30		MU 02	PB 0059 - 1
UELAK	205 - 16	1.0000	25.40	1.3110	33.30		MU 02	PB 0059 - 2
SAAK	205 - 16	1.0000	25.40	1.3110	33.30		MU 02	PB 0059 - 3
SBAK	205 - 16	1.0000	25.40	1.3110	33.30		MU 02	PB 0059 - 4
UCP	205 - 16	1.0000	25.40	1.4370	36.50		MU 03	PB 0060 - 1
UELP	205 - 16	1.0000	25.40	1.4370	36.50		MU 03	PB 0060 - 2
SAP	205 - 16	1.0000	25.40	1.4370	36.50		MU 03	PB 0060 - 3
SBP	205 - 16	1.0000	25.40	1.4370	36.50		MU 03	PB 0060 - 4
UCPA	205 - 16	1.0000	25.40	1.4370	36.50		MU 04	PB 0061 - 1
UCP X05	205 - 16	1.0000	25.40	1.7480	44.40		MU 07	PB 0062 - 1
UCP 305	205 - 16	1.0000	25.40	1.7717	45.00		MU 08	PB 0063 - 1
SAPP	206 - 17	1.0625	26.99	1.3110	33.30		MU 01	PB 0064 - 1
SBPP	206 - 17	1.0625	26.99	1.3110	33.30		MU 01	PB 0064 - 2

DIMENSIONS

PILLOW BLOCKS DIMENSIONS

HYC	Number	ID		SB		Graphic	Figure No.	Group No.
		in	mm	in	mm			
UCAK	206 - 17	1.0625	26.99	1.5630	39.70		MU 02	PB 0065 - 1
UELAK	206 - 17	1.0625	26.99	1.5630	39.70		MU 02	PB 0065 - 2
SAAK	206 - 17	1.0625	26.99	1.5630	39.70		MU 02	PB 0065 - 3
SBAK	206 - 17	1.0625	26.99	1.5630	39.70		MU 02	PB 0065 - 4
UCP	206 - 17	1.0625	26.99	1.6890	42.90		MU 03	PB 0066 - 1
UELP	206 - 17	1.0625	26.99	1.6890	42.90		MU 03	PB 0066 - 2
SAP	206 - 17	1.0625	26.99	1.6890	42.90		MU 03	PB 0066 - 3
UCPA	206 - 17	1.0625	26.99	1.6890	42.90		MU 04	PB 0067 - 1
UCP X06	206 - 17	1.0625	26.99	1.8740	47.60		MU 07	PB 0068 - 1
UCP 306	206 - 17	1.0625	26.99	1.9685	50.00		MU 08	PB 0069 - 1
SAPP	206 - 18	1.1250	28.58	1.3228	33.60		MU 01	PB 0070 - 1
SBPP	206 - 18	1.1250	28.58	1.3228	33.60		MU 01	PB 0070 - 2
UCAK	206 - 18	1.1250	28.58	1.5630	39.70		MU 02	PB 0071 - 1
UELAK	206 - 18	1.1250	28.58	1.5630	39.70		MU 02	PB 0071 - 2
SAAK	206 - 18	1.1250	28.58	1.5630	39.70		MU 02	PB 0071 - 3
SBAK	206 - 18	1.1250	28.58	1.5630	39.70		MU 02	PB 0071 - 4
UCP	206 - 18	1.1250	28.58	1.6890	42.90		MU 03	PB 0072 - 1
UELP	206 - 18	1.1250	28.58	1.6890	42.90		MU 03	PB 0072 - 2
SAP	206 - 18	1.1250	28.58	1.6890	42.90		MU 03	PB 0072 - 3
SBP	206 - 18	1.1250	28.58	1.6890	42.90		MU 03	PB 0072 - 4
UCPA	206 - 18	1.1250	28.58	1.6890	42.90		MU 04	PB 0073 - 1
UCP X06	206 - 18	1.1250	28.58	1.8740	47.60		MU 07	PB 0074 - 1
UCP 306	206 - 18	1.1250	28.58	1.9685	50.00		MU 08	PB 0075 - 1
SAPP	206	1.1811	30.00	1.3110	33.30		MU 01	PB 0076 - 1
SBPP	206	1.1811	30.00	1.3110	33.30		MU 01	PB 0076 - 2
UCAK	206	1.1811	30.00	1.5630	39.70		MU 02	PB 0077 - 1
UELAK	206	1.1811	30.00	1.5630	39.70		MU 02	PB 0077 - 2
SAAK	206	1.1811	30.00	1.5630	39.70		MU 02	PB 0077 - 3
SBAK	206	1.1811	30.00	1.5630	39.70		MU 02	PB 0077 - 4
UCP	206	1.1811	30.00	1.6890	42.90		MU 03	PB 0078 - 1
UELP	206	1.1811	30.00	1.6890	42.90		MU 03	PB 0078 - 2
SAP	206	1.1811	30.00	1.6890	42.90		MU 03	PB 0078 - 3
SBP	206	1.1811	30.00	1.6890	42.90		MU 03	PB 0078 - 4
UCPA	206	1.1811	30.00	1.6890	42.90		MU 04	PB 0079 - 1
UKP	207	1.1811	30.00	1.8740	47.60		MU 05	PB 0080 - 1
UKPA	207	1.1811	30.00	1.8740	47.60		MU 06	PB 0081 - 1
UCP X06	206	1.1811	30.00	1.8740	47.60		MU 07	PB 0082 - 1
UCP 306	206	1.1811	30.00	1.9685	50.00		MU 08	PB 0083 - 1
SAPP	206 - 19	1.1875	30.16	1.3110	33.30		MU 01	PB 0084 - 1
SBPP	206 - 19	1.1875	30.16	1.3110	33.30		MU 01	PB 0084 - 2
UCAK	206 - 19	1.1875	30.16	1.5630	39.70		MU 02	PB 0085 - 1
UELAK	206 - 19	1.1875	30.16	1.5630	39.70		MU 02	PB 0085 - 2

PILLOW BLOCKS **DIMENSIONS**

HYC	Number	ID		SB		Graphic	Figure No.	Group No.
		in	mm	in	mm			
SAAK	206 - 19	1.1875	30.16	1.5630	39.70		MU 02	PB 0085 - 3
SBAK	206 - 19	1.1875	30.16	1.5630	39.70		MU 02	PB 0085 - 4
UCP	206 - 19	1.1875	30.16	1.6890	42.90		MU 03	PB 0086 - 1
UELP	206 - 19	1.1875	30.16	1.6890	42.90		MU 03	PB 0086 - 2
SAP	206 - 19	1.1875	30.16	1.6890	42.90		MU 03	PB 0086 - 3
SBP	206 - 19	1.1875	30.16	1.6890	42.90		MU 03	PB 0086 - 4
UCPA	206 - 19	1.1875	30.16	1.6890	42.90		MU 04	PB 0087 - 1
UCP	X06 - 19	1.1875	30.16	1.8740	47.60		MU 07	PB 0088 - 1
UCP	306 - 19	1.1875	30.16	1.9685	50.00		MU 08	PB 0089 - 1
SAPP	206 - 20	1.2500	31.75	1.3110	33.30		MU 01	PB 0090 - 1
SBPP	206 - 20	1.2500	31.75	1.3110	33.30		MU 01	PB 0090 - 2
SAPP	207 - 20	1.2500	31.75	1.5630	39.70		MU 01	PB 0091 - 1
SBPP	207 - 20	1.2500	31.75	1.5630	39.70		MU 01	PB 0091 - 2
UCAK	206 - 20	1.2500	31.75	1.5630	39.70		MU 02	PB 0092 - 1
UELAK	206 - 20	1.2500	31.75	1.5630	39.70		MU 02	PB 0092 - 2
SAAK	206 - 20	1.2500	31.75	1.5630	39.70		MU 02	PB 0092 - 3
SBAK	206 - 20	1.2500	31.75	1.5630	39.70		MU 02	PB 0092 - 4
UCP	206 - 20	1.2500	31.75	1.6890	42.90		MU 03	PB 0093 - 1
UELP	206 - 20	1.2500	31.75	1.6890	42.90		MU 03	PB 0093 - 2
SAP	206 - 20	1.2500	31.75	1.6890	42.90		MU 03	PB 0093 - 3
SBP	206 - 20	1.2500	31.75	1.6890	42.90		MU 03	PB 0093 - 4
UCPA	206 - 20	1.2500	31.75	1.6890	42.90		MU 04	PB 0094 - 1
UCAK	207 - 20	1.2500	31.75	1.8110	46.00		MU 02	PB 0095 - 1
UELAK	207 - 20	1.2500	31.75	1.8110	46.00		MU 02	PB 0095 - 2
SAAK	207 - 20	1.2500	31.75	1.8110	46.00		MU 02	PB 0095 - 3
SBAK	207 - 20	1.2500	31.75	1.8110	46.00		MU 02	PB 0095 - 4
UCP	207 - 20	1.2500	31.75	1.8740	47.60		MU 03	PB 0096 - 1
UELP	207 - 20	1.2500	31.75	1.8740	47.60		MU 03	PB 0096 - 2
SAP	207 - 20	1.2500	31.75	1.8740	47.60		MU 03	PB 0096 - 3
SBP	207 - 20	1.2500	31.75	1.8740	47.60		MU 03	PB 0096 - 4
UCPA	207 - 20	1.2500	31.75	1.8740	47.60		MU 04	PB 0097 - 1
UCP	X06 - 20	1.2500	31.75	1.8740	47.60		MU 07	PB 0098 - 1
UCP	306 - 20	1.2500	31.75	1.9685	50.00		MU 08	PB 0099 - 1
UCP	X07 - 20	1.2500	31.75	2.1260	54.00		MU 07	PB 0100 - 1
UCP	307 - 20	1.2500	31.75	2.2047	56.00		MU 08	PB 0101 - 1
SAPP	207 - 21	1.3125	33.34	1.5630	39.70		MU 01	PB 0102 - 1
SBPP	207 - 21	1.3125	33.34	1.5630	39.70		MU 01	PB 0102 - 2
UCAK	207 - 21	1.3125	33.34	1.8110	46.00		MU 02	PB 0103 - 1
UELAK	207 - 21	1.3125	33.34	1.8110	46.00		MU 02	PB 0103 - 2
SAAK	207 - 21	1.3125	33.34	1.8110	46.00		MU 02	PB 0103 - 3
SAAK	207 - 21	1.3125	33.34	1.8110	46.00		MU 02	PB 0103 - 4
UCP	207 - 21	1.3125	33.34	1.8740	47.60		MU 03	PB 0104 - 1











































DIMENSIONS

PILLOW BLOCKS DIMENSIONS

HYC	Number	ID		SB		Graphic	Figure No.	Group No.
		in	mm	in	mm			
UEL	207 - 21	1.3125	33.34	1.8740	47.60		MU 03	PB 0104 - 2
SAP	207 - 21	1.3125	33.34	1.8740	47.60		MU 03	PB 0104 - 3
SBP	207 - 21	1.3125	33.34	1.8740	47.60		MU 03	PB 0104 - 4
UCPA	207 - 21	1.3125	33.34	1.8740	47.60		MU 04	PB 0105 - 1
UCP	X07 - 21	1.3125	33.34	2.1260	54.00		MU 07	PB 0106 - 1
UCP	307 - 21	1.3125	33.34	2.2047	56.00		MU 08	PB 0107 - 1
SAPP	207 - 22	1.3750	34.93	1.5630	39.70		MU 01	PB 0108 - 1
SBPP	207 - 22	1.3750	34.93	1.5630	39.70		MU 01	PB 0108 - 2
UCAK	207 - 22	1.3750	34.93	1.8110	46.00		MU 02	PB 0109 - 1
UELAK	207 - 22	1.3750	34.93	1.8110	46.00		MU 02	PB 0109 - 2
SAAK	207 - 22	1.3750	34.93	1.8110	46.00		MU 02	PB 0109 - 3
SBAK	207 - 22	1.3750	34.93	1.8110	46.00		MU 02	PB 0109 - 4
UCP	207 - 22	1.3750	34.93	1.8740	47.60		MU 03	PB 0110 - 1
UEL	207 - 22	1.3750	34.93	1.8740	47.60		MU 03	PB 0110 - 2
SAP	207 - 22	1.3750	34.93	1.8740	47.60		MU 03	PB 0110 - 3
SBP	207 - 22	1.3750	34.93	1.8740	47.60		MU 03	PB 0110 - 4
UCPA	207 - 22	1.3750	34.93	1.8740	47.60		MU 04	PB 0111 - 1
UCP	X07 - 22	1.3750	34.93	2.1260	54.00		MU 07	PB 0112 - 1
UCP	307 - 22	1.3750	34.93	2.2047	56.00		MU 08	PB 0113 - 1
SAPP	207	1.3780	35.00	1.5630	39.70		MU 01	PB 0114 - 1
SBPP	207	1.3780	35.00	1.5630	39.70		MU 01	PB 0114 - 2
UCAK	207	1.3780	35.00	1.8110	46.00		MU 02	PB 0115 - 1
UELAK	207	1.3780	35.00	1.8110	46.00		MU 02	PB 0115 - 2
SAAK	207	1.3780	35.00	1.8110	46.00		MU 02	PB 0115 - 3
SBAK	207	1.3780	35.00	1.8110	46.00		MU 02	PB 0115 - 4
UCP	207	1.3780	35.00	1.8740	47.60		MU 03	PB 0116 - 1
UEL	207	1.3780	35.00	1.8740	47.60		MU 03	PB 0116 - 2
SAP	207	1.3780	35.00	1.8740	47.60		MU 03	PB 0116 - 3
SBP	207	1.3780	35.00	1.8740	47.60		MU 03	PB 0116 - 4
UCPA	207	1.3780	35.00	1.8740	47.60		MU 04	PB 0117 - 1
UKP	208	1.3780	35.00	1.9370	49.20		MU 05	PB 0118 - 1
UKPA	208	1.3780	35.00	1.9370	49.20		MU 06	PB 0119 - 1
UCP	X07	1.3780	35.00	2.1260	54.00		MU 07	PB 0120 - 1
UCP	307	1.3780	35.00	2.2047	56.00		MU 08	PB 0121 - 1
SAPP	207 - 23	1.4375	36.51	1.5630	39.70		MU 01	PB 0122 - 1
SBPP	207 - 23	1.4375	36.51	1.5630	39.70		MU 01	PB 0122 - 2
UCAK	207 - 23	1.4375	36.51	1.8110	46.00		MU 02	PB 0123 - 1
UELAK	207 - 23	1.4375	36.51	1.8110	46.00		MU 02	PB 0123 - 2
SAAK	207 - 23	1.4375	36.51	1.8110	46.00		MU 02	PB 0123 - 3
SBAK	207 - 23	1.4375	36.51	1.8110	46.00		MU 02	PB 0123 - 4
UCP	207 - 23	1.4375	36.51	1.8740	47.60		MU 03	PB 0124 - 1
UEL	207 - 23	1.4375	36.51	1.8740	47.60		MU 03	PB 0124 - 2











































PILLOW BLOCKS

DIMENSIONS

HYC	Number	ID		SB		Graphic	Figure No.	Group No.
		in	mm	in	mm			
SAP	207 - 23	1.4375	36.51	1.8740	47.60		MU 03	PB 0124 - 3
SBP	207 - 23	1.4375	36.51	1.8740	47.60		MU 03	PB 0124 - 4
UCPA	207 - 23	1.4375	36.51	1.8740	47.60		MU 04	PB 0125 - 1
UCP	X07 - 23	1.4375	36.51	2.1260	54.00		MU 07	PB 0126 - 1
UCP	307 - 23	1.4375	36.51	2.2047	56.00		MU 08	PB 0127 - 1
UCAK	208 - 24	1.5000	38.10	1.9370	49.20		MU 02	PB 0128 - 1
UELAK	208 - 24	1.5000	38.10	1.9370	49.20		MU 02	PB 0128 - 2
SAAK	208 - 24	1.5000	38.10	1.9370	49.20		MU 02	PB 0128 - 3
SBAK	208 - 24	1.5000	38.10	1.9370	49.20		MU 02	PB 0128 - 4
UCP	208 - 24	1.5000	38.10	1.9370	49.20		MU 03	PB 0129 - 1
UELP	208 - 24	1.5000	38.10	1.9370	49.20		MU 03	PB 0129 - 2
SAP	208 - 24	1.5000	38.10	1.9370	49.20		MU 03	PB 0129 - 3
SBP	208 - 24	1.5000	38.10	1.9370	49.20		MU 03	PB 0129 - 4
UCPA	208 - 24	1.5000	38.10	1.9370	49.20		MU 04	PB 0130 - 1
UCP	X08 - 24	1.5000	38.10	2.3110	58.70		MU 07	PB 0131 - 1
UCP	308 - 24	1.5000	38.10	2.3622	60.00		MU 08	PB 0132 - 1
UCAK	208 - 25	1.5625	39.69	1.9370	49.20		MU 02	PB 0133 - 1
UELAK	208 - 25	1.5625	39.69	1.9370	49.20		MU 02	PB 0133 - 2
SAAK	208 - 25	1.5625	39.69	1.9370	49.20		MU 02	PB 0133 - 3
UCP	208 - 25	1.5625	39.69	1.9370	49.20		MU 03	PB 0134 - 1
UELP	208 - 25	1.5625	39.69	1.9370	49.20		MU 03	PB 0134 - 2
SAP	208 - 25	1.5625	39.69	1.9370	49.20		MU 03	PB 0134 - 3
UCPA	208 - 25	1.5625	39.69	1.9370	49.20		MU 04	PB 0135 - 1
UCP	X08 - 25	1.5625	39.69	2.3110	58.70		MU 07	PB 0136 - 1
UCP	308 - 25	1.5625	39.69	2.3622	60.00		MU 08	PB 0137 - 1
UCAK	208	1.5748	40.00	1.9370	49.20		MU 02	PB 0138 - 1
UELAK	208	1.5748	40.00	1.9370	49.20		MU 02	PB 0138 - 2
SAAK	208	1.5748	40.00	1.9370	49.20		MU 02	PB 0138 - 3
SBAK	208	1.5748	40.00	1.9370	49.20		MU 02	PB 0138 - 4
UCP	208	1.5748	40.00	1.9370	49.20		MU 03	PB 0139 - 1
UELP	208	1.5748	40.00	1.9370	49.20		MU 03	PB 0139 - 2
SAP	208	1.5748	40.00	1.9370	49.20		MU 03	PB 0139 - 3
SBP	208	1.5748	40.00	1.9370	49.20		MU 03	PB 0139 - 4
UCPA	208	1.5748	40.00	1.9370	49.20		MU 04	PB 0140 - 1
UKP	209	1.5748	40.00	2.1260	54.00		MU 05	PB 0141 - 1
UKPA	209	1.5748	40.00	2.1339	54.20		MU 06	PB 0142 - 1
UCP	X08	1.5748	40.00	2.3110	58.70		MU 07	PB 0143 - 1
UCP	308	1.5748	40.00	2.3622	60.00		MU 08	PB 0144 - 1
UCAK	209 - 26	1.6250	41.28	2.0630	52.40		MU 02	PB 0145 - 1
UELAK	209 - 26	1.6250	41.28	2.0630	52.40		MU 02	PB 0145 - 2
SAAK	209 - 26	1.6250	41.28	2.0630	52.40		MU 02	PB 0145 - 3
UCP	209 - 26	1.6250	41.28	2.1260	54.00		MU 03	PB 0146 - 1











































DIMENSIONS

PILLOW BLOCKS DIMENSIONS

HYC	Number	ID		SB		Graphic	Figure No.	Group No.
		in	mm	in	mm			
UERP	209 - 26	1.6250	41.28	2.1260	54.00		MU 03	PB 0146 - 2
SAP	209 - 26	1.6250	41.28	2.1260	54.00		MU 03	PB 0146 - 3
UCPA	209 - 26	1.6250	41.28	2.1339	54.20		MU 04	PB 0147 - 1
UCP	X09 - 26	1.6250	41.28	2.3110	58.70		MU 07	PB 0148 - 1
UCP	309 - 26	1.6250	41.28	2.6378	67.00		MU 08	PB 0149 - 1
UCAK	209 - 27	1.6875	42.86	2.0630	52.40		MU 02	PB 0150 - 1
UELAK	209 - 27	1.6875	42.86	2.0630	52.40		MU 02	PB 0150 - 2
SAAK	209 - 27	1.6875	42.86	2.0630	52.40		MU 02	PB 0150 - 3
UCP	209 - 27	1.6875	42.86	2.1260	54.00		MU 03	PB 0151 - 1
UERP	209 - 27	1.6875	42.86	2.1260	54.00		MU 03	PB 0151 - 2
SAP	209 - 27	1.6875	42.86	2.1260	54.00		MU 03	PB 0151 - 3
UCPA	209 - 27	1.6875	42.86	2.1339	54.20		MU 04	PB 0152 - 1
UCP	X09 - 27	1.6875	42.86	2.3110	58.70		MU 07	PB 0153 - 1
UCP	309 - 27	1.6875	42.86	2.6378	67.00		MU 08	PB 0154 - 1
UCAK	209 - 28	1.7500	44.45	2.0630	52.40		MU 02	PB 0155 - 1
UELAK	209 - 28	1.7500	44.45	2.0630	52.40		MU 02	PB 0155 - 2
SAAK	209 - 28	1.7500	44.45	2.0630	52.40		MU 02	PB 0155 - 3
UCP	209 - 28	1.7500	44.45	2.1260	54.00		MU 03	PB 0156 - 1
UERP	209 - 28	1.7500	44.45	2.1260	54.00		MU 03	PB 0156 - 2
SAP	209 - 28	1.7500	44.45	2.1260	54.00		MU 03	PB 0156 - 3
UCPA	209 - 28	1.7500	44.45	2.1339	54.20		MU 04	PB 0157 - 1
UCP	X09 - 28	1.7500	44.45	2.3110	58.70		MU 07	PB 0158 - 1
UCP	309 - 28	1.7500	44.45	2.6378	67.00		MU 08	PB 0159 - 1
UCAK	209	1.7717	45.00	2.0630	52.40		MU 02	PB 0160 - 1
UELAK	209	1.7717	45.00	2.0630	52.40		MU 02	PB 0160 - 2
SAAK	209	1.7717	45.00	2.0630	52.40		MU 02	PB 0160 - 3
UCP	209	1.7717	45.00	2.1260	54.00		MU 03	PB 0161 - 1
UERP	209	1.7717	45.00	2.1260	54.00		MU 03	PB 0161 - 2
SAP	209	1.7717	45.00	2.1260	54.00		MU 03	PB 0161 - 3
UCPA	209	1.7717	45.00	2.1339	54.20		MU 04	PB 0162 - 1
UKP	210	1.7717	45.00	2.2520	57.20		MU 05	PB 0163 - 1
UKPA	210	1.7717	45.00	2.2520	57.20		MU 06	PB 0164 - 1
UCP	X09	1.7717	45.00	2.3110	58.70		MU 07	PB 0165 - 1
UCP	309	1.7717	45.00	2.6378	67.00		MU 08	PB 0166 - 1
UCAK	210 - 29	1.8125	46.04	2.1890	55.60		MU 02	PB 0167 - 1
UELAK	210 - 29	1.8125	46.04	2.1890	55.60		MU 02	PB 0167 - 2
SAAK	210 - 29	1.8125	46.04	2.1890	55.60		MU 02	PB 0167 - 3
UCP	210 - 29	1.8125	46.04	2.2520	57.20		MU 03	PB 0168 - 1
UERP	210 - 29	1.8125	46.04	2.2520	57.20		MU 03	PB 0168 - 2
SAP	210 - 29	1.8125	46.04	2.2520	57.20		MU 03	PB 0168 - 3
UCPA	210 - 29	1.8125	46.04	2.2520	57.20		MU 04	PB 0169 - 1
UCP	X10 - 29	1.8125	46.04	2.3110	58.70		MU 07	PB 0170 - 1











































PILLOW BLOCKS

DIMENSIONS

HYC	Number	ID		SB		Graphic	Figure No.	Group No.
		in	mm	in	mm			
UCP 310 - 29		1.8125	46.04	2.6378	67.00		MU 08	PB 0171 - 1
UCAK 210 - 30		1.8750	47.63	2.1890	55.60		MU 02	PB 0172 - 1
UELAK 210 - 30		1.8750	47.63	2.1890	55.60		MU 02	PB 0172 - 2
SAAK 210 - 30		1.8750	47.63	2.1890	55.60		MU 02	PB 0172 - 3
UCP 210 - 30		1.8750	47.63	2.2520	57.20		MU 03	PB 0173 - 1
UELP 210 - 30		1.8750	47.63	2.2520	57.20		MU 03	PB 0173 - 2
SAP 210 - 30		1.8750	47.63	2.2520	57.20		MU 03	PB 0173 - 3
UCPA 210 - 30		1.8750	47.63	2.2520	57.20		MU 04	PB 0174 - 1
UCP X10 - 30		1.8750	47.63	2.5000	63.50		MU 07	PB 0175 - 1
UCP 310 - 30		1.8750	47.63	2.9528	75.00		MU 08	PB 0176 - 1
UCAK 210 - 31		1.9375	49.21	2.1890	55.60		MU 02	PB 0177 - 1
UELAK 210 - 31		1.9375	49.21	2.1890	55.60		MU 02	PB 0177 - 2
SAAK 210 - 31		1.9375	49.21	2.1890	55.60		MU 02	PB 0177 - 3
UCP 210 - 31		1.9375	49.21	2.2520	57.20		MU 03	PB 0178 - 1
UELP 210 - 31		1.9375	49.21	2.2520	57.20		MU 03	PB 0178 - 2
SAP 210 - 31		1.9375	49.21	2.2520	57.20		MU 03	PB 0178 - 3
UCPA 210 - 31		1.9375	49.21	2.2520	57.20		MU 04	PB 0179 - 1
UCP X10 - 31		1.9375	49.21	2.5000	63.50		MU 07	PB 0180 - 1
UCP 310 - 31		1.9375	49.21	2.9528	75.00		MU 08	PB 0181 - 1
UCAK 210		1.9685	50.00	2.1890	55.60		MU 02	PB 0182 - 1
UELAK 210		1.9685	50.00	2.1890	55.60		MU 02	PB 0182 - 2
SAAK 210		1.9685	50.00	2.1890	55.60		MU 02	PB 0182 - 3
UCP 210		1.9685	50.00	2.2520	57.20		MU 03	PB 0183 - 1
UELP 210		1.9685	50.00	2.2520	57.20		MU 03	PB 0183 - 2
SAP 210		1.9685	50.00	2.2520	57.20		MU 03	PB 0183 - 3
UCPA 210		1.9685	50.00	2.2520	57.20		MU 04	PB 0184 - 1
UKP 211		1.9685	50.00	2.5000	63.50		MU 05	PB 0185 - 1
UKPA 211		1.9685	50.00	2.5000	63.50		MU 06	PB 0186 - 1
UCP X10		1.9685	50.00	2.5000	63.50		MU 07	PB 0187 - 1
UCP 310		1.9685	50.00	2.9528	75.00		MU 08	PB 0188 - 1
UCAK 210 - 32		2.0000	50.80	2.1890	55.60		MU 02	PB 0189 - 1
UELAK 210 - 32		2.0000	50.80	2.1890	55.60		MU 02	PB 0189 - 2
SAAK 210 - 32		2.0000	50.80	2.1890	55.60		MU 02	PB 0189 - 3
UCP 210 - 32		2.0000	50.80	2.2520	57.20		MU 03	PB 0190 - 1
UELP 210 - 32		2.0000	50.80	2.2520	57.20		MU 03	PB 0190 - 2
SAP 210 - 32		2.0000	50.80	2.2520	57.20		MU 03	PB 0190 - 3
UCPA 210 - 32		2.0000	50.80	2.2520	57.20		MU 04	PB 0191 - 1
UCAK 211 - 32		2.0000	50.80	2.4370	61.90		MU 02	PB 0192 - 1
UELAK 211 - 32		2.0000	50.80	2.4370	61.90		MU 02	PB 0192 - 2
SAAK 211 - 32		2.0000	50.80	2.4370	61.90		MU 02	PB 0192 - 3
UCP 211 - 32		2.0000	50.80	2.5000	63.50		MU 03	PB 0193 - 1
UELP 211 - 32		2.0000	50.80	2.5000	63.50		MU 03	PB 0193 - 2











































DIMENSIONS

PILLOW BLOCKS **DIMENSIONS**

HYC	Number	ID		SB		Graphic	Figure No.	Group No.
		in	mm	in	mm			
SAP 211 - 32		2.0000	50.80	2.5000	63.50		MU 03	PB 0193 - 3
UCPA 211 - 32		2.0000	50.80	2.5000	63.50		MU 04	PB 0194 - 1
UCP X10 - 32		2.0000	50.80	2.5000	63.50		MU 07	PB 0195 - 1
UCP X11 - 32		2.0000	50.80	2.7480	69.80		MU 07	PB 0196 - 1
UCP 310 - 32		2.0000	50.80	2.9528	75.00		MU 08	PB 0197 - 1
UCP 311 - 32		2.0000	50.80	3.1496	80.00		MU 08	PB 0198 - 1
UCAK 211 - 33		2.0625	52.39	2.4370	61.90		MU 02	PB 0199 - 1
UELAK 211 - 33		2.0625	52.39	2.4370	61.90		MU 02	PB 0199 - 2
SAAK 211 - 33		2.0625	52.39	2.4370	61.90		MU 02	PB 0199 - 3
UCP 211 - 33		2.0625	52.39	2.5000	63.50		MU 03	PB 0200 - 1
UELP 211 - 33		2.0625	52.39	2.5000	63.50		MU 03	PB 0200 - 2
SAP 211 - 33		2.0625	52.39	2.5000	63.50		MU 03	PB 0200 - 3
UCPA 211 - 33		2.0625	52.39	2.5000	63.50		MU 04	PB 0201 - 1
UCP X11 - 33		2.0625	52.39	2.7480	69.80		MU 07	PB 0202 - 1
UCP 311 - 33		2.0625	52.39	3.1496	80.00		MU 08	PB 0203 - 1
UCAK 211 - 34		2.1250	53.98	2.4370	61.90		MU 02	PB 0204 - 1
UELAK 211 - 34		2.1250	53.98	2.4370	61.90		MU 02	PB 0204 - 2
SAAK 211 - 34		2.1250	53.98	2.4370	61.90		MU 02	PB 0204 - 3
UCP 211 - 34		2.1250	53.98	2.5000	63.50		MU 03	PB 0205 - 1
UELP 211 - 34		2.1250	53.98	2.5000	63.50		MU 03	PB 0205 - 2
SAP 211 - 34		2.1250	53.98	2.5000	63.50		MU 03	PB 0205 - 3
UCPA 211 - 34		2.1250	53.98	2.5000	63.50		MU 04	PB 0206 - 1
UCP X11 - 34		2.1250	53.98	2.7480	69.80		MU 07	PB 0207 - 1
UCP 311 - 34		2.1250	53.98	3.1496	80.00		MU 08	PB 0208 - 1
UCAK 211		2.1654	55.00	2.4370	61.90		MU 02	PB 0209 - 1
UELAK 211		2.1654	55.00	2.4370	61.90		MU 02	PB 0209 - 2
SAAK 211		2.1654	55.00	2.4370	61.90		MU 02	PB 0209 - 3
UCP 211		2.1654	55.00	2.5000	63.50		MU 03	PB 0210 - 1
UELP 211		2.1654	55.00	2.5000	63.50		MU 03	PB 0210 - 2
SAP 211		2.1654	55.00	2.5000	63.50		MU 03	PB 0210 - 3
UCPA 211		2.1654	55.00	2.5000	63.50		MU 04	PB 0211 - 1
UCP X11		2.1654	55.00	2.7480	69.80		MU 07	PB 0212 - 1
UKP 212		2.1654	55.00	2.7520	69.90		MU 05	PB 0213 - 1
UKPA 212		2.1654	55.00	2.7520	69.90		MU 06	PB 0214 - 1
UCP 311		2.1654	55.00	3.1496	80.00		MU 08	PB 0215 - 1
UCAK 211 - 35		2.1875	55.56	2.4370	61.90		MU 02	PB 0216 - 1
UELAK 211 - 35		2.1875	55.56	2.4370	61.90		MU 02	PB 0216 - 2
SAAK 211 - 35		2.1875	55.56	2.4370	61.90		MU 02	PB 0216 - 3
UCP 211 - 35		2.1875	55.56	2.5000	63.50		MU 03	PB 0217 - 1
UELP 211 - 35		2.1875	55.56	2.5000	63.50		MU 03	PB 0217 - 2
SAP 211 - 35		2.1875	55.56	2.5000	63.50		MU 03	PB 0217 - 3
UCPA 211 - 35		2.1875	55.56	2.5000	63.50		MU 04	PB 0218 - 1

PILLOW BLOCKS

DIMENSIONS

HYC	Number	ID		SB		Graphic	Figure No.	Group No.
		in	mm	in	mm			
UCP X11 - 35		2.1875	55.56	2.7480	69.80		MU 07	PB 0219 - 1
UCP 311 - 35		2.1875	55.56	3.1496	80.00		MU 08	PB 0220 - 1
UCAK 212 - 36		2.2500	57.15	2.6890	68.30		MU 02	PB 0221 - 1
UELAK 212 - 36		2.2500	57.15	2.6890	68.30		MU 02	PB 0221 - 2
UCP 212 - 36		2.2500	57.15	2.7520	69.90		MU 03	PB 0222 - 1
UELP 212 - 36		2.2500	57.15	2.7520	69.90		MU 03	PB 0222 - 2
UCPA 212 - 36		2.2500	57.15	2.7520	69.90		MU 04	PB 0223 - 1
UCP X12 - 36		2.2500	57.15	3.0000	76.20		MU 07	PB 0224 - 1
UCP 312 - 36		2.2500	57.15	3.3465	85.00		MU 08	PB 0225 - 1
UCAK 212 - 37		2.3125	58.74	2.6890	68.30		MU 02	PB 0226 - 1
UELAK 212 - 37		2.3125	58.74	2.6890	68.30		MU 02	PB 0226 - 2
UCP 212 - 37		2.3125	58.74	2.7520	69.90		MU 03	PB 0227 - 1
UELP 212 - 37		2.3125	58.74	2.7520	69.90		MU 03	PB 0227 - 2
UCPA 212 - 37		2.3125	58.74	2.7520	69.90		MU 04	PB 0228 - 1
UCP X12 - 37		2.3125	58.74	3.0000	76.20		MU 07	PB 0229 - 1
UCP 312 - 37		2.3125	58.74	3.3465	85.00		MU 08	PB 0230 - 1
UCAK 212		2.3622	60.00	2.6890	68.30		MU 02	PB 0231 - 1
UELAK 212		2.3622	60.00	2.6890	68.30		MU 02	PB 0231 - 2
UCP 212		2.3622	60.00	2.7520	69.90		MU 03	PB 0232 - 1
UELP 212		2.3622	60.00	2.7520	69.90		MU 03	PB 0232 - 2
UCPA 212		2.3622	60.00	2.7520	69.90		MU 04	PB 0233 - 1
UKP 213		2.3622	60.00	3.0000	76.20		MU 05	PB 0234 - 1
UKPA 213		2.3622	60.00	3.0000	76.20		MU 06	PB 0235 - 1
UCP X12		2.3622	60.00	3.0000	76.20		MU 07	PB 0236 - 1
UCP 312		2.3622	60.00	3.3465	85.00		MU 08	PB 0237 - 1
UCAK 212 - 38		2.3750	60.33	2.6890	68.30		MU 02	PB 0238 - 1
UELAK 212 - 38		2.3750	60.33	2.6890	68.30		MU 02	PB 0238 - 2
UCP 212 - 38		2.3750	60.33	2.7283	69.30		MU 03	PB 0239 - 1
UELP 212 - 38		2.3750	60.33	2.7283	69.30		MU 03	PB 0239 - 2
UCPA 212 - 38		2.3750	60.33	2.7283	69.30		MU 04	PB 0240 - 1
UCP X12 - 38		2.3750	60.33	3.0000	76.20		MU 07	PB 0241 - 1
UCP 312 - 38		2.3750	60.33	3.3465	85.00		MU 08	PB 0242 - 1
UCAK 212 - 39		2.4375	61.91	2.6890	68.30		MU 02	PB 0243 - 1
UELAK 212 - 39		2.4375	61.91	2.6890	68.30		MU 02	PB 0243 - 2
UCP 212 - 39		2.4375	61.91	2.7520	69.90		MU 03	PB 0244 - 1
UELP 212 - 39		2.4375	61.91	2.7520	69.90		MU 03	PB 0244 - 2
UCPA 212 - 39		2.4375	61.91	2.7520	69.90		MU 04	PB 0245 - 1
UCP X12 - 39		2.4375	61.91	3.0000	76.20		MU 07	PB 0246 - 1
UCP 312 - 39		2.4375	61.91	3.3465	85.00		MU 08	PB 0247 - 1
UCAK 213 - 40		2.5000	63.50	2.9370	74.60		MU 02	PB 0248 - 1
UELAK 213 - 40		2.5000	63.50	2.9370	74.60		MU 02	PB 0248 - 2
UCP 213 - 40		2.5000	63.50	3.0000	76.20		MU 03	PB 0249 - 1

DIMENSIONS

PILLOW BLOCKS DIMENSIONS

HYC	Number	ID		SB		Graphic	Figure No.	Group No.
		in	mm	in	mm			
U	ELP 213 - 40	2.5000	63.50	3.0000	76.20		MU 03	PB 0249 - 2
U	CPA 213 - 40	2.5000	63.50	3.0000	76.20		MU 04	PB 0250 - 1
U	CP X13 - 40	2.5000	63.50	3.0000	76.20		MU 07	PB 0251 - 1
U	CP 313 - 40	2.5000	63.50	3.5433	90.00		MU 08	PB 0252 - 1
U	CAK 213	2.5591	65.00	2.9370	74.60		MU 02	PB 0253 - 1
U	ELAK 213	2.5591	65.00	2.9370	74.60		MU 02	PB 0253 - 2
U	CP 213	2.5591	65.00	3.0000	76.20		MU 03	PB 0254 - 1
U	ELP 213	2.5591	65.00	3.0000	76.20		MU 03	PB 0254 - 2
U	CPA 213	2.5591	65.00	3.0000	76.20		MU 04	PB 0255 - 1
U	CP X13	2.5591	65.00	3.0000	76.20		MU 07	PB 0256 - 1
U	CP 313	2.5591	65.00	3.5433	90.00		MU 08	PB 0257 - 1
U	CAK 213 - 41	2.5625	65.09	2.9370	74.60		MU 02	PB 0258 - 1
U	CP 213 - 41	2.5625	65.09	3.0000	76.20		MU 03	PB 0259 - 1
U	ELP 213 - 41	2.5625	65.09	3.0000	76.20		MU 03	PB 0259 - 2
U	CPA 213 - 41	2.5625	65.09	3.0000	76.20		MU 04	PB 0260 - 1
U	CP X13 - 41	2.5625	65.09	3.0000	76.20		MU 07	PB 0261 - 1
U	CP 313 - 41	2.5625	65.09	3.5433	90.00		MU 08	PB 0262 - 1
U	CAK 214 - 42	2.6250	66.68	3.0630	77.80		MU 02	PB 0263 - 1
U	CP 214 - 42	2.6250	66.68	3.1260	79.40		MU 03	PB 0264 - 1
U	ELP 214 - 42	2.6250	66.68	3.1260	79.40		MU 03	PB 0264 - 2
U	CP X14 - 42	2.6250	66.68	3.5000	88.90		MU 07	PB 0265 - 1
U	CP 314 - 42	2.6250	66.68	3.7402	95.00		MU 08	PB 0266 - 1
U	CAK 214 - 43	2.6875	68.26	3.0630	77.80		MU 02	PB 0267 - 1
U	ELAK 214 - 43	2.6875	68.26	3.0630	77.80		MU 02	PB 0267 - 2
U	CP 214 - 43	2.6875	68.26	3.1260	79.40		MU 03	PB 0268 - 1
U	ELP 214 - 43	2.6875	68.26	3.1260	79.40		MU 03	PB 0268 - 2
U	CP X14 - 43	2.6875	68.26	3.5000	88.90		MU 07	PB 0269 - 1
U	CP 314 - 43	2.6875	68.26	3.7402	95.00		MU 08	PB 0270 - 1
U	CAK 214 - 44	2.7500	69.85	3.0630	77.80		MU 02	PB 0271 - 1
U	ELAK 214 - 44	2.7500	69.85	3.0630	77.80		MU 02	PB 0271 - 2
U	CP 214 - 44	2.7500	69.85	3.1260	79.40		MU 03	PB 0272 - 1
U	ELP 214 - 44	2.7500	69.85	3.1260	79.40		MU 03	PB 0272 - 2
U	CP X14 - 44	2.7500	69.85	3.5000	88.90		MU 07	PB 0273 - 1
U	CP 314 - 44	2.7500	69.85	3.7402	95.00		MU 08	PB 0274 - 1
U	CAK 214	2.7559	70.00	3.0630	77.80		MU 02	PB 0275 - 1
U	ELAK 214	2.7559	70.00	3.0630	77.80		MU 02	PB 0275 - 2
U	CP 214	2.7559	70.00	3.1260	79.40		MU 03	PB 0276 - 1
U	ELP 214	2.7559	70.00	3.1260	79.40		MU 03	PB 0276 - 2
U	CP X14	2.7559	70.00	3.5000	88.90		MU 07	PB 0277 - 1
U	CP 314	2.7559	70.00	3.7402	95.00		MU 08	PB 0278 - 1
U	CAK 215 - 45	2.8125	71.44	3.2520	82.60		MU 02	PB 0279 - 1
U	CP 215 - 45	2.8125	71.44	3.2520	82.60		MU 03	PB 0280 - 1











































PILLOW BLOCKS

DIMENSIONS

HYC	Number	ID		SB		Graphic	Figure No.	Group No.
		in	mm	in	mm			
UEL	215 - 45	2.8125	71.44	3.2520	82.60		MU 03	PB 0280 - 2
UCP	X15 - 45	2.8125	71.44	3.5000	88.90		MU 07	PB 0281 - 1
UCP	315 - 45	2.8125	71.44	3.9370	100.00		MU 08	PB 0282 - 1
UCA	215 - 46	2.8750	73.03	3.2520	82.60		MU 02	PB 0283 - 1
UEL	215 - 46	2.8750	73.03	3.2520	82.60		MU 02	PB 0283 - 2
UCP	215 - 46	2.8750	73.03	3.2520	82.60		MU 03	PB 0284 - 1
UEL	215 - 46	2.8750	73.03	3.2520	82.60		MU 03	PB 0284 - 2
UCP	X15 - 46	2.8750	73.03	3.5000	88.90		MU 07	PB 0285 - 1
UCP	315 - 46	2.8750	73.03	3.9370	100.00		MU 08	PB 0286 - 1
UCA	215 - 47	2.9375	74.61	3.2520	82.60		MU 02	PB 0287 - 1
UEL	215 - 47	2.9375	74.61	3.2520	82.60		MU 02	PB 0287 - 2
UCP	215 - 47	2.9375	74.61	3.2520	82.60		MU 03	PB 0288 - 1
UEL	215 - 47	2.9375	74.61	3.2520	82.60		MU 03	PB 0288 - 2
UCP	X15 - 47	2.9375	74.61	3.5000	88.90		MU 07	PB 0289 - 1
UCP	315 - 47	2.9375	74.61	3.9370	100.00		MU 08	PB 0290 - 1
UCA	215	2.9528	75.00	3.2520	82.60		MU 02	PB 0291 - 1
UEL	215	2.9528	75.00	3.2520	82.60		MU 02	PB 0291 - 2
UCP	215	2.9528	75.00	3.2520	82.60		MU 03	PB 0292 - 1
UEL	215	2.9528	75.00	3.2520	82.60		MU 03	PB 0292 - 2
UCP	X15	2.9528	75.00	3.5000	88.90		MU 07	PB 0293 - 1
UCP	315	2.9528	75.00	3.9370	100.00		MU 08	PB 0294 - 1
UCA	215 - 48	3.0000	76.20	3.2520	82.60		MU 02	PB 0295 - 1
UCP	215 - 48	3.0000	76.20	3.2520	82.60		MU 03	PB 0296 - 1
UEL	215 - 48	3.0000	76.20	3.2520	82.60		MU 03	PB 0296 - 2
UCP	X15 - 48	3.0000	76.20	3.5000	88.90		MU 07	PB 0297 - 1
UCP	315 - 48	3.0000	76.20	3.9370	100.00		MU 08	PB 0298 - 1
UCP	216 - 49	3.0625	77.79	3.5000	88.90		MU 03	PB 0299 - 1
UCP	X16 - 49	3.0625	77.79	4.0000	101.60		MU 07	PB 0300 - 1
UCP	316 - 49	3.0625	77.79	4.1732	106.00		MU 08	PB 0301 - 1
UCP	216 - 50	3.1250	79.38	3.5000	88.90		MU 03	PB 0302 - 1
UCP	X16 - 50	3.1250	79.38	4.0000	101.60		MU 07	PB 0303 - 1
UCP	316 - 50	3.1250	79.38	4.1732	106.00		MU 08	PB 0304 - 1
UCP	216	3.1496	80.00	3.5000	88.90		MU 03	PB 0305 - 1
UCP	X16	3.1496	80.00	4.0000	101.60		MU 07	PB 0306 - 1
UCP	316	3.1496	80.00	4.1732	106.00		MU 08	PB 0307 - 1
UCP	216 - 51	3.1875	80.96	3.5000	88.90		MU 03	PB 0308 - 1
UCP	217 - 52	3.2500	82.55	3.7480	95.20		MU 03	PB 0309 - 1
UCP	217 - 53	3.3125	84.14	3.7480	95.20		MU 03	PB 0310 - 1
UCP	217	3.3465	85.00	3.7480	95.20		MU 03	PB 0311 - 1
UCP	217 - 55	3.4375	87.31	3.7480	95.20		MU 03	PB 0312 - 1
UCP	218 - 56	3.5000	88.90	4.0000	101.60		MU 03	PB 0313 - 1
UCP	218	3.5433	90.00	4.0000	101.60		MU 03	PB 0314 - 1

DIMENSIONS

FLANGED UNITS DIMENSIONS











































HYC	Number	ID		SB		Graphic	Figure No.	Group No.
		in	mm	in	mm			
SAPF	201	0.4724	12.00	2.5000	63.50		MU 09	FU 0001 - 1
SBPF	201	0.4724	12.00	2.5000	63.50		MU 09	FU 0001 - 2
SAPFL	201	0.4724	12.00	2.5000	63.50		MU 10	FU 0002 - 1
SBPFL	201	0.4724	12.00	2.5000	63.50		MU 10	FU 0002 - 2
UCF	201	0.4724	12.00	2.5197	64.00		MU 12	FU 0003 - 1
UCFC	201	0.4724	12.00	3.0709	78.00		MU 13	FU 0004 - 1
UCFL	201	0.4724	12.00	3.5433	90.00		MU 15	FU 0005 - 1
SAPF	201 - 8	0.5000	12.70	2.5000	63.50		MU 09	FU 0006 - 1
SBPF	201 - 8	0.5000	12.70	2.5000	63.50		MU 09	FU 0006 - 2
SAPFL	201 - 8	0.5000	12.70	2.5000	63.50		MU 10	FU 0007 - 1
SBPFL	201 - 8	0.5000	12.70	2.5000	63.50		MU 10	FU 0007 - 2
UCF	201 - 8	0.5000	12.70	2.5197	64.00		MU 12	FU 0008 - 1
UCFC	201 - 8	0.5000	12.70	3.0709	78.00		MU 13	FU 0009 - 1
UCFL	201 - 8	0.5000	12.70	3.5433	90.00		MU 15	FU 0010 - 1
SAPF	202 - 9	0.5625	14.29	2.5000	63.50		MU 09	FU 0011 - 1
SBPF	202 - 9	0.5625	14.29	2.5000	63.50		MU 09	FU 0011 - 2
SAPFL	202 - 9	0.5625	14.29	2.5000	63.50		MU 10	FU 0012 - 1
SBPFL	202 - 9	0.5625	14.29	2.5000	63.50		MU 10	FU 0012 - 2
UCF	202 - 9	0.5625	14.29	2.5197	64.00		MU 12	FU 0013 - 1
UCFC	202 - 9	0.5625	14.29	3.0709	78.00		MU 13	FU 0014 - 1
UCFL	202 - 9	0.5625	14.29	3.5433	90.00		MU 15	FU 0015 - 1
SAPF	202	0.5906	15.00	2.5000	63.50		MU 09	FU 0016 - 1
SBPF	202	0.5906	15.00	2.5000	63.50		MU 09	FU 0016 - 2
SAPFL	202	0.5906	15.00	2.5000	63.50		MU 10	FU 0017 - 1
SBPFL	202	0.5906	15.00	2.5000	63.50		MU 10	FU 0017 - 2
UCF	202	0.5906	15.00	2.5197	64.00		MU 12	FU 0018 - 1
UELF	202	0.5906	15.00	2.5197	64.00		MU 12	FU 0018 - 2
UCFC	202	0.5906	15.00	3.0709	78.00		MU 13	FU 0019 - 1
UELFC	202	0.5906	15.00	3.0709	78.00		MU 13	FU 0019 - 2
UCFL	202	0.5906	15.00	3.5433	90.00		MU 15	FU 0020 - 1
UELFL	202	0.5906	15.00	3.5433	90.00		MU 15	FU 0020 - 2
SAPF	202 - 10	0.6250	15.88	2.5000	63.50		MU 09	FU 0021 - 1
SBPF	202 - 10	0.6250	15.88	2.5000	63.50		MU 09	FU 0021 - 2
SAPFL	202 - 10	0.6250	15.88	2.5000	63.50		MU 10	FU 0022 - 1
SBPFL	202 - 10	0.6250	15.88	2.5000	63.50		MU 10	FU 0022 - 2
UCF	202 - 10	0.6250	15.88	2.5197	64.00		MU 12	FU 0023 - 1
UELF	202 - 10	0.6250	15.88	2.5197	64.00		MU 12	FU 0023 - 2
UCFC	202 - 10	0.6250	15.88	3.0709	78.00		MU 13	FU 0024 - 1
UCFL	202 - 10	0.6250	15.88	3.5433	90.00		MU 15	FU 0025 - 1
UELFL	202 - 10	0.6250	15.88	3.5433	90.00		MU 15	FU 0025 - 2
SAPF	203	0.6693	17.00	2.5000	63.50		MU 09	FU 0026 - 1
SBPF	203	0.6693	17.00	2.5000	63.50		MU 09	FU 0026 - 2

FLANGED UNITS DIMENSIONS

HYC	Number	ID		SB		Graphic	Figure No.	Group No.
		in	mm	in	mm			
SAPFL	203	0.6693	17.00	2.5000	63.50		MU 10	FU 0027 - 1
SBPFL	203	0.6693	17.00	2.5000	63.50		MU 10	FU 0027 - 2
UCF	203	0.6693	17.00	2.5197	64.00		MU 12	FU 0028 - 1
UELF	203	0.6693	17.00	2.5197	64.00		MU 12	FU 0028 - 2
UCFC	203	0.6693	17.00	3.0709	78.00		MU 13	FU 0029 - 1
UELFC	203	0.6693	17.00	3.0709	78.00		MU 13	FU 0029 - 2
UCFL	203	0.6693	17.00	3.5433	90.00		MU 15	FU 0030 - 1
UELFL	203	0.6693	17.00	3.5433	90.00		MU 15	FU 0030 - 2
SAPF	203 - 11	0.6875	17.46	2.5000	63.50		MU 09	FU 0031 - 1
SBPF	203 - 11	0.6875	17.46	2.5000	63.50		MU 09	FU 0031 - 2
SAPFL	203 - 11	0.6875	17.46	2.5000	63.50		MU 10	FU 0032 - 1
SBPFL	203 - 11	0.6875	17.46	2.5000	63.50		MU 10	FU 0032 - 2
UCF	203 - 11	0.6875	17.46	2.5197	64.00		MU 12	FU 0033 - 1
UCFC	203 - 11	0.6875	17.46	3.0709	78.00		MU 13	FU 0034 - 1
UCFL	203 - 11	0.6875	17.46	3.5433	90.00		MU 15	FU 0035 - 1
UCFS	204 - 12	0.7500	19.05	2.5000	63.50		MU 11	FU 0036 - 1
UELFS	204 - 12	0.7500	19.05	2.5000	63.50		MU 11	FU 0036 - 2
SAFS	204 - 12	0.7500	19.05	2.5000	63.50		MU 11	FU 0036 - 3
SBFS	204 - 12	0.7500	19.05	2.5000	63.50		MU 11	FU 0036 - 4
UCF	204 - 12	0.7500	19.05	2.5197	64.00		MU 12	FU 0037 - 1
UELF	204 - 12	0.7500	19.05	2.5197	64.00		MU 12	FU 0037 - 2
SAF	204 - 12	0.7500	19.05	2.5197	64.00		MU 12	FU 0037 - 3
SBF	204 - 12	0.7500	19.05	2.5197	64.00		MU 12	FU 0037 - 4
SAPF	204 - 12	0.7500	19.05	2.8150	71.50		MU 09	FU 0038 - 1
SBPF	204 - 12	0.7500	19.05	2.8150	71.50		MU 09	FU 0038 - 2
SAPFL	204 - 12	0.7500	19.05	2.8150	71.50		MU 10	FU 0039 - 1
SBPFL	204 - 12	0.7500	19.05	2.8150	71.50		MU 10	FU 0039 - 2
UCFC	204 - 12	0.7500	19.05	3.0709	78.00		MU 13	FU 0040 - 1
UELFC	204 - 12	0.7500	19.05	3.0709	78.00		MU 13	FU 0040 - 2
SAFC	204 - 12	0.7500	19.05	3.0709	78.00		MU 13	FU 0040 - 3
SBFC	204 - 12	0.7500	19.05	3.0709	78.00		MU 13	FU 0040 - 4
UCFT	204 - 12	0.7500	19.05	3.5433	90.00		MU 14	FU 0041 - 1
UELFT	204 - 12	0.7500	19.05	3.5433	90.00		MU 14	FU 0041 - 2
SAFT	204 - 12	0.7500	19.05	3.5433	90.00		MU 14	FU 0041 - 3
SBFT	204 - 12	0.7500	19.05	3.5433	90.00		MU 14	FU 0041 - 4
UCFL	204 - 12	0.7500	19.05	3.5433	90.00		MU 15	FU 0042 - 1
UELFL	204 - 12	0.7500	19.05	3.5433	90.00		MU 15	FU 0042 - 2
SAFL	204 - 12	0.7500	19.05	3.5433	90.00		MU 15	FU 0042 - 3
SBFL	204 - 12	0.7500	19.05	3.5433	90.00		MU 15	FU 0042 - 4
UCFS	204	0.7874	20.00	2.5000	63.50		MU 11	FU 0043 - 1
UELFS	204	0.7874	20.00	2.5000	63.50		MU 11	FU 0043 - 2
SAFS	204	0.7874	20.00	2.5000	63.50		MU 11	FU 0043 - 3

DIMENSIONS

FLANGED UNITS DIMENSIONS











































HYC	Number	ID		SB		Graphic	Figure No.	Group No.
		in	mm	in	mm			
SBFS	204	0.7874	20.00	2.5000	63.50		MU 11	FU 0043 - 4
UCF	204	0.7874	20.00	2.5197	64.00		MU 12	FU 0044 - 1
UELF	204	0.7874	20.00	2.5197	64.00		MU 12	FU 0044 - 2
SAF	204	0.7874	20.00	2.5197	64.00		MU 12	FU 0044 - 3
SBF	204	0.7874	20.00	2.5197	64.00		MU 12	FU 0044 - 4
UKF	205	0.7874	20.00	2.7559	70.00		MU 16	FU 0045 - 1
SAPF	204	0.7874	20.00	2.8150	71.50		MU 09	FU 0046 - 1
SBPF	204	0.7874	20.00	2.8150	71.50		MU 09	FU 0046 - 2
SAPFL	204	0.7874	20.00	2.8150	71.50		MU 10	FU 0047 - 1
SBPFL	204	0.7874	20.00	2.8150	71.50		MU 10	FU 0047 - 2
UCFC	204	0.7874	20.00	3.0709	78.00		MU 13	FU 0048 - 1
UELFC	204	0.7874	20.00	3.0709	78.00		MU 13	FU 0048 - 2
SAFC	204	0.7874	20.00	3.0709	78.00		MU 13	FU 0048 - 3
SBFC	204	0.7874	20.00	3.0709	78.00		MU 13	FU 0048 - 4
UCFT	204	0.7874	20.00	3.5433	90.00		MU 14	FU 0049 - 1
UELFT	204	0.7874	20.00	3.5433	90.00		MU 14	FU 0049 - 2
SAFT	204	0.7874	20.00	3.5433	90.00		MU 14	FU 0049 - 3
SBFT	204	0.7874	20.00	3.5433	90.00		MU 14	FU 0049 - 4
UCFL	204	0.7874	20.00	3.5433	90.00		MU 15	FU 0050 - 1
UELFL	204	0.7874	20.00	3.5433	90.00		MU 15	FU 0050 - 2
SAFL	204	0.7874	20.00	3.5433	90.00		MU 15	FU 0050 - 3
SBFL	204	0.7874	20.00	3.5433	90.00		MU 15	FU 0050 - 4
UKFC	205	0.7874	20.00	3.5433	90.00		MU 17	FU 0051 - 1
UKFL	205	0.7874	20.00	3.8976	99.00		MU 18	FU 0052 - 1
UCF	205 - 13	0.8125	20.64	2.7559	70.00		MU 12	FU 0053 - 1
UELF	205 - 13	0.8125	20.64	2.7559	70.00		MU 12	FU 0053 - 2
SAF	205 - 13	0.8125	20.64	2.7559	70.00		MU 12	FU 0053 - 3
SAPF	205 - 13	0.8125	20.64	2.9921	76.00		MU 09	FU 0054 - 1
SBPF	205 - 13	0.8125	20.64	2.9921	76.00		MU 09	FU 0054 - 2
SAPFL	205 - 13	0.8125	20.64	2.9921	76.00		MU 10	FU 0055 - 1
SBPFL	205 - 13	0.8125	20.64	2.9921	76.00		MU 10	FU 0055 - 2
UCF	305 - 13	0.8125	20.64	3.1496	80.00		MU 21	FU 0056 - 1
UCF	X05 - 13	0.8125	20.64	3.2480	82.50		MU 19	FU 0057 - 1
UCFC	205 - 13	0.8125	20.64	3.5433	90.00		MU 13	FU 0058 - 1
UELFC	205 - 13	0.8125	20.64	3.5433	90.00		MU 13	FU 0058 - 2
UCFT	205 - 13	0.8125	20.64	3.8976	99.00		MU 14	FU 0059 - 1
UELFT	205 - 13	0.8125	20.64	3.8976	99.00		MU 14	FU 0059 - 2
SAFT	205 - 13	0.8125	20.64	3.8976	99.00		MU 14	FU 0059 - 3
UCFL	205 - 13	0.8125	20.64	3.8976	99.00		MU 15	FU 0060 - 1
UELFL	205 - 13	0.8125	20.64	3.8976	99.00		MU 15	FU 0060 - 2
SAFL	205 - 13	0.8125	20.64	3.8976	99.00		MU 15	FU 0060 - 3
UCFL	305 - 13	0.8125	20.64	4.4488	113.00		MU 22	FU 0061 - 1

FLANGED UNITS DIMENSIONS

HYC	Number	ID		SB		Graphic	Figure No.	Group No.
		in	mm	in	mm			
UCFL X05 - 13		0.8125	20.64	4.6063	117.00		MU 20	FU 0062 - 1
UCFS 205 - 13		0.8125	20.64	2.7559	70.0		MU 11	FU 0063 - 1
UELFS 205 - 13		0.8125	20.64	2.7559	70.0		MU 11	FU 0063 - 2
SAFS 205 - 13		0.8125	20.64	2.7559	70.0		MU 11	FU 0063 - 3
UCF 205 - 14		0.8750	22.23	2.7559	70.00		MU 12	FU 0064 - 1
UELF 205 - 14		0.8750	22.23	2.7559	70.00		MU 12	FU 0064 - 2
SAF 205 - 14		0.8750	22.23	2.7559	70.00		MU 12	FU 0064 - 3
SBF 205 - 14		0.8750	22.23	2.7559	70.00		MU 12	FU 0064 - 4
SAPF 205 - 14		0.8750	22.23	2.9921	76.00		MU 09	FU 0065 - 1
SBPF 205 - 14		0.8750	22.23	2.9921	76.00		MU 09	FU 0065 - 2
SAPFL 205 - 14		0.8750	22.23	2.9921	76.00		MU 10	FU 0066 - 1
SBPFL 205 - 14		0.8750	22.23	2.9921	76.00		MU 10	FU 0066 - 2
UCF 305 - 14		0.8750	22.23	3.1496	80.00		MU 21	FU 0067 - 1
UCF X05 - 14		0.8750	22.23	3.2480	82.50		MU 19	FU 0068 - 1
UCFC 205 - 14		0.8750	22.23	3.5433	90.00		MU 13	FU 0069 - 1
UELFC 205 - 14		0.8750	22.23	3.5433	90.00		MU 13	FU 0069 - 2
SAFC 205 - 14		0.8750	22.23	3.5433	90.00		MU 13	FU 0069 - 3
SBFC 205 - 14		0.8750	22.23	3.5433	90.00		MU 13	FU 0069 - 4
UCFT 205 - 14		0.8750	22.23	3.8976	99.00		MU 14	FU 0070 - 1
UELFT 205 - 14		0.8750	22.23	3.8976	99.00		MU 14	FU 0070 - 2
SAFT 205 - 14		0.8750	22.23	3.8976	99.00		MU 14	FU 0070 - 3
SBFT 205 - 14		0.8750	22.23	3.8976	99.00		MU 14	FU 0070 - 4
UCFL 205 - 14		0.8750	22.23	3.8976	99.00		MU 15	FU 0071 - 1
UELFL 205 - 14		0.8750	22.23	3.8976	99.00		MU 15	FU 0071 - 2
SAFL 205 - 14		0.8750	22.23	3.8976	99.00		MU 15	FU 0071 - 3
SBFL 205 - 14		0.8750	22.23	3.8976	99.00		MU 15	FU 0071 - 4
UCFL 305 - 14		0.8750	22.23	4.4488	113.00		MU 22	FU 0072 - 1
UCFL X05 - 14		0.8750	22.23	4.6063	117.00		MU 20	FU 0073 - 1
UCFS 205 - 14		0.8750	22.23	2.7559	70.0		MU 11	FU 0074 - 1
UELFS 205 - 14		0.8750	22.23	2.7559	70.0		MU 11	FU 0074 - 2
SAFS 205 - 14		0.8750	22.23	2.7559	70.0		MU 11	FU 0074 - 3
SBFS 205 - 14		0.8750	22.23	2.7559	70.0		MU 11	FU 0074 - 4
UCF 205 - 15		0.9375	23.81	2.7559	70.00		MU 12	FU 0075 - 1
UELF 205 - 15		0.9375	23.81	2.7559	70.00		MU 12	FU 0075 - 2
SAF 205 - 15		0.9375	23.81	2.7559	70.00		MU 12	FU 0075 - 3
SBF 205 - 15		0.9375	23.81	2.7559	70.00		MU 12	FU 0075 - 4
SAPF 205 - 15		0.9375	23.81	2.9921	76.00		MU 09	FU 0076 - 1
SBPF 205 - 15		0.9375	23.81	2.9921	76.00		MU 09	FU 0076 - 2
SAPFL 205 - 15		0.9375	23.81	2.9921	76.00		MU 10	FU 0077 - 1
SBPFL 205 - 15		0.9375	23.81	2.9921	76.00		MU 10	FU 0077 - 2
UCF 305 - 15		0.9375	23.81	3.1496	80.00		MU 21	FU 0078 - 1
UCF X05 - 15		0.9375	23.81	3.2480	82.50		MU 19	FU 0079 - 1

DIMENSIONS

FLANGED UNITS DIMENSIONS











































HYC	Number	ID		SB		Graphic	Figure No.	Group No.
		in	mm	in	mm			
UCFC	205 - 15	0.9375	23.81	3.5433	90.00		MU 13	FU 0080 - 1
UEFC	205 - 15	0.9375	23.81	3.5433	90.00		MU 13	FU 0080 - 2
SAFC	205 - 15	0.9375	23.81	3.5433	90.00		MU 13	FU 0080 - 3
SBFC	205 - 15	0.9375	23.81	3.5433	90.00		MU 13	FU 0080 - 4
UCFT	205 - 15	0.9375	23.81	3.8976	99.00		MU 14	FU 0081 - 1
UEFT	205 - 15	0.9375	23.81	3.8976	99.00		MU 14	FU 0081 - 2
SAFT	205 - 15	0.9375	23.81	3.8976	99.00		MU 14	FU 0081 - 3
SBFT	205 - 15	0.9375	23.81	3.8976	99.00		MU 14	FU 0081 - 4
UCFL	205 - 15	0.9375	23.81	3.8976	99.00		MU 15	FU 0082 - 1
UEFL	205 - 15	0.9375	23.81	3.8976	99.00		MU 15	FU 0082 - 2
SAFL	205 - 15	0.9375	23.81	3.8976	99.00		MU 15	FU 0082 - 3
SBFL	205 - 15	0.9375	23.81	3.8976	99.00		MU 15	FU 0082 - 4
UCFL	305 - 15	0.9375	23.81	4.4488	113.00		MU 22	FU 0083 - 1
UCFL	X05 - 15	0.9375	23.81	4.6063	117.00		MU 20	FU 0084 - 1
UCFS	205 - 15	0.9375	23.81	2.7559	70.0		MU 11	FU 0085 - 1
UEFS	205 - 15	0.9375	23.81	2.7559	70.0		MU 11	FU 0085 - 2
SAFS	205 - 15	0.9375	23.81	2.7559	70.0		MU 11	FU 0085 - 3
SBFS	205 - 15	0.9375	23.81	2.7559	70.0		MU 11	FU 0085 - 4
UCF	205	0.9843	25.00	2.7559	70.00		MU 12	FU 0086 - 1
UELF	205	0.9843	25.00	2.7559	70.00		MU 12	FU 0086 - 2
SAF	205	0.9843	25.00	2.7559	70.00		MU 12	FU 0086 - 3
SBF	205	0.9843	25.00	2.7559	70.00		MU 12	FU 0086 - 4
SAPF	205	0.9843	25.00	2.9921	76.00		MU 09	FU 0087 - 1
SBPF	205	0.9843	25.00	2.9921	76.00		MU 09	FU 0087 - 2
SAPFL	205	0.9843	25.00	2.9921	76.00		MU 10	FU 0088 - 1
SBPFL	205	0.9843	25.00	2.9921	76.00		MU 10	FU 0088 - 2
UCF	305	0.9843	25.00	3.1496	80.00		MU 21	FU 0089 - 1
UCF	X05	0.9843	25.00	3.2480	82.50		MU 19	FU 0090 - 1
UKF	206	0.9843	25.00	3.2677	83.00		MU 16	FU 0091 - 1
UCFC	205	0.9843	25.00	3.5433	90.00		MU 13	FU 0092 - 1
UEFC	205	0.9843	25.00	3.5433	90.00		MU 13	FU 0092 - 2
SAFC	205	0.9843	25.00	3.5433	90.00		MU 13	FU 0092 - 3
SBFC	205	0.9843	25.00	3.5433	90.00		MU 13	FU 0092 - 4
UCFT	205	0.9843	25.00	3.8976	99.00		MU 14	FU 0093 - 1
UEFT	205	0.9843	25.00	3.8976	99.00		MU 14	FU 0093 - 2
SAFT	205	0.9843	25.00	3.8976	99.00		MU 14	FU 0093 - 3
SBFT	205	0.9843	25.00	3.8976	99.00		MU 14	FU 0093 - 4
UCFL	205	0.9843	25.00	3.8976	99.00		MU 15	FU 0094 - 1
UEFL	205	0.9843	25.00	3.8976	99.00		MU 15	FU 0094 - 2
SAFL	205	0.9843	25.00	3.8976	99.00		MU 15	FU 0094 - 3
SBFL	205	0.9843	25.00	3.8976	99.00		MU 15	FU 0094 - 4
UKFC	206	0.9843	25.00	3.9370	100.00		MU 17	FU 0095 - 1

FLANGED UNITS DIMENSIONS

HYC	Number	ID		SB		Graphic	Figure No.	Group No.
		in	mm	in	mm			
UCFL 305		0.9843	25.00	4.4488	113.00		MU 22	FU 0096 - 1
UKFL 206		0.9843	25.00	4.6063	117.00		MU 18	FU 0097 - 1
UCFL X05		0.9843	25.00	4.6063	117.00		MU 20	FU 0098 - 1
UCFS 205		0.9843	25.00	2.7559	70.0		MU 11	FU 0099 - 1
UELFS 205		0.9843	25.00	2.7559	70.0		MU 11	FU 0099 - 2
SAFS 205		0.9843	25.00	2.7559	70.0		MU 11	FU 0099 - 3
SBFS 205		0.9843	25.00	2.7559	70.0		MU 11	FU 0099 - 4
UCF 205 - 16		1.0000	25.40	2.7559	70.00		MU 12	FU 0100 - 1
UELF 205 - 16		1.0000	25.40	2.7559	70.00		MU 12	FU 0100 - 2
SAF 205 - 16		1.0000	25.40	2.7559	70.00		MU 12	FU 0100 - 3
SBF 205 - 16		1.0000	25.40	2.7559	70.00		MU 12	FU 0100 - 4
SAPF 205 - 16		1.0000	25.40	2.9921	76.00		MU 09	FU 0101 - 1
SBPF 205 - 16		1.0000	25.40	2.9921	76.00		MU 09	FU 0101 - 2
SAPFL 205 - 16		1.0000	25.40	2.9921	76.00		MU 10	FU 0102 - 1
SBPFL 205 - 16		1.0000	25.40	2.9921	76.00		MU 10	FU 0102 - 2
UCF 305 - 16		1.0000	25.40	3.1496	80.00		MU 21	FU 0103 - 1
UCF X05 - 16		1.0000	25.40	3.2480	82.50		MU 19	FU 0104 - 1
UCFC 205 - 16		1.0000	25.40	3.5433	90.00		MU 13	FU 0105 - 1
UELFC 205 - 16		1.0000	25.40	3.5433	90.00		MU 13	FU 0105 - 2
SAFC 205 - 16		1.0000	25.40	3.5433	90.00		MU 13	FU 0105 - 3
SBFC 205 - 16		1.0000	25.40	3.5433	90.00		MU 13	FU 0105 - 4
UCFT 205 - 16		1.0000	25.40	3.8976	99.00		MU 14	FU 0106 - 1
UELFT 205 - 16		1.0000	25.40	3.8976	99.00		MU 14	FU 0106 - 2
SAFT 205 - 16		1.0000	25.40	3.8976	99.00		MU 14	FU 0106 - 3
SBFT 205 - 16		1.0000	25.40	3.8976	99.00		MU 14	FU 0106 - 4
UCFL 205 - 16		1.0000	25.40	3.8976	99.00		MU 15	FU 0107 - 1
UELFL 205 - 16		1.0000	25.40	3.8976	99.00		MU 15	FU 0107 - 2
SAFL 205 - 16		1.0000	25.40	3.8976	99.00		MU 15	FU 0107 - 3
SBFL 205 - 16		1.0000	25.40	3.8976	99.00		MU 15	FU 0107 - 4
UCFL 305 - 16		1.0000	25.40	4.4488	113.00		MU 22	FU 0108 - 1
UCFL X05 - 16		1.0000	25.40	4.6063	117.00		MU 20	FU 0109 - 1
UCFS 205 - 16		1.0000	25.40	2.7559	70.0		MU 11	FU 0110 - 1
UELFS 205 - 16		1.0000	25.40	2.7559	70.0		MU 11	FU 0110 - 2
SAFS 205 - 16		1.0000	25.40	2.7559	70.0		MU 11	FU 0110 - 3
SBFS 205 - 16		1.0000	25.40	2.7559	70.0		MU 11	FU 0110 - 4
UCFS 206 - 17		1.0625	26.99	3.2480	82.50		MU 11	FU 0111 - 1
UELFS 206 - 17		1.0625	26.99	3.2480	82.50		MU 11	FU 0111 - 2
SAFS 206 - 17		1.0625	26.99	3.2480	82.50		MU 11	FU 0111 - 3
UCF 206 - 17		1.0625	26.99	3.2677	83.00		MU 12	FU 0112 - 1
UELF 206 - 17		1.0625	26.99	3.2677	83.00		MU 12	FU 0112 - 2
SAF 206 - 17		1.0625	26.99	3.2677	83.00		MU 12	FU 0112 - 3
SAPF 206 - 17		1.0625	26.99	3.5630	90.50		MU 09	FU 0113 - 1

DIMENSIONS

FLANGED UNITS DIMENSIONS

HYC	Number	ID		SB		Graphic	Figure No.	Group No.
		in	mm	in	mm			
SBPF	206 - 17	1.0625	26.99	3.5630	90.50		MU 09	FU 0113 - 2
SAPFL	206 - 17	1.0625	26.99	3.5630	90.50		MU 10	FU 0114 - 1
SBPFL	206 - 17	1.0625	26.99	3.5630	90.50		MU 10	FU 0114 - 2
UCF	X06 - 17	1.0625	26.99	3.6220	92.00		MU 19	FU 0115 - 1
UCF	306 - 17	1.0625	26.99	3.7402	95.00		MU 21	FU 0116 - 1
UCFC	206 - 17	1.0625	26.99	3.9370	100.00		MU 13	FU 0117 - 1
UELFC	206 - 17	1.0625	26.99	3.9370	100.00		MU 13	FU 0117 - 2
UCFT	206 - 17	1.0625	26.99	4.5866	116.50		MU 14	FU 0118 - 1
UELFT	206 - 17	1.0625	26.99	4.5866	116.50		MU 14	FU 0118 - 2
SAFT	206 - 17	1.0625	26.99	4.5866	116.50		MU 14	FU 0118 - 3
UCFL	206 - 17	1.0625	26.99	4.6063	117.00		MU 15	FU 0119 - 1
UELFL	206 - 17	1.0625	26.99	4.6063	117.00		MU 15	FU 0119 - 2
SAFL	206 - 17	1.0625	26.99	4.6063	117.00		MU 15	FU 0119 - 3
UCFL	X06 - 17	1.0625	26.99	5.1181	130.00		MU 20	FU 0120 - 1
UCFL	306 - 17	1.0625	26.99	5.2756	134.00		MU 22	FU 0121 - 1
UCFS	206 - 18	1.1250	28.58	3.2480	82.50		MU 11	FU 0122 - 1
UELFS	206 - 18	1.1250	28.58	3.2480	82.50		MU 11	FU 0122 - 2
SAFS	206 - 18	1.1250	28.58	3.2480	82.50		MU 11	FU 0122 - 3
SBFS	206 - 18	1.1250	28.58	3.2480	82.50		MU 11	FU 0122 - 4
UCF	206 - 18	1.1250	28.58	3.2677	83.00		MU 12	FU 0123 - 1
UELF	206 - 18	1.1250	28.58	3.2677	83.00		MU 12	FU 0123 - 2
SAF	206 - 18	1.1250	28.58	3.2677	83.00		MU 12	FU 0123 - 3
SBF	206 - 18	1.1250	28.58	3.2677	83.00		MU 12	FU 0123 - 4
SAPF	206 - 18	1.1250	28.58	3.5630	90.50		MU 09	FU 0124 - 1
SBPF	206 - 18	1.1250	28.58	3.5630	90.50		MU 09	FU 0124 - 2
SAPFL	206 - 18	1.1250	28.58	3.5630	90.50		MU 10	FU 0125 - 1
SBPFL	206 - 18	1.1250	28.58	3.5630	90.50		MU 10	FU 0125 - 2
UCF	X06 - 18	1.1250	28.58	3.6220	92.00		MU 19	FU 0126 - 1
UCF	306 - 18	1.1250	28.58	3.7402	95.00		MU 21	FU 0127 - 1
UCFC	206 - 18	1.1250	28.58	3.9370	100.00		MU 13	FU 0128 - 1
UELFC	206 - 18	1.1250	28.58	3.9370	100.00		MU 13	FU 0128 - 2
SAFC	206 - 18	1.1250	28.58	3.9370	100.00		MU 13	FU 0128 - 3
SBFC	206 - 18	1.1250	28.58	3.9370	100.00		MU 13	FU 0128 - 4
UCFT	206 - 18	1.1250	28.58	4.5866	116.50		MU 14	FU 0129 - 1
UELFT	206 - 18	1.1250	28.58	4.5866	116.50		MU 14	FU 0129 - 2
SAFT	206 - 18	1.1250	28.58	4.5866	116.50		MU 14	FU 0129 - 3
SBFT	206 - 18	1.1250	28.58	4.5866	116.50		MU 14	FU 0129 - 4
UCFL	206 - 18	1.1250	28.58	4.6063	117.00		MU 15	FU 0130 - 1
UELFL	206 - 18	1.1250	28.58	4.6063	117.00		MU 15	FU 0130 - 2
SAFL	206 - 18	1.1250	28.58	4.6063	117.00		MU 15	FU 0130 - 3
SBFL	206 - 18	1.1250	28.58	4.6063	117.00		MU 15	FU 0130 - 4
UCFL	X06 - 18	1.1250	28.58	5.1181	130.00		MU 20	FU 0131 - 1

FLANGED UNITS DIMENSIONS











































HYC	Number	ID		SB		Graphic	Figure No.	Group No.
		in	mm	in	mm			
UCFL 306 - 18		1.1250	28.58	5.2756	134.00		MU 22	FU 0132 - 1
UCFS 206		1.1811	30.00	3.2480	82.50		MU 11	FU 0133 - 1
UELFS 206		1.1811	30.00	3.2480	82.50		MU 11	FU 0133 - 2
SAFS 206		1.1811	30.00	3.2480	82.50		MU 11	FU 0133 - 3
SBFS 206		1.1811	30.00	3.2480	82.50		MU 11	FU 0133 - 4
UCF 206		1.1811	30.00	3.2677	83.00		MU 12	FU 0134 - 1
UELF 206		1.1811	30.00	3.2677	83.00		MU 12	FU 0134 - 2
SAF 206		1.1811	30.00	3.2677	83.00		MU 12	FU 0134 - 3
SBF 206		1.1811	30.00	3.2677	83.00		MU 12	FU 0134 - 4
SAPF 206		1.1811	30.00	3.5630	90.50		MU 09	FU 0135 - 1
SBPF 206		1.1811	30.00	3.5630	90.50		MU 09	FU 0135 - 2
SAPFL 206		1.1811	30.00	3.5630	90.50		MU 10	FU 0136 - 1
SBPFL 206		1.1811	30.00	3.5630	90.50		MU 10	FU 0136 - 2
UKF 207		1.1811	30.00	3.6220	92.00		MU 16	FU 0137 - 1
UCF X06		1.1811	30.00	3.6220	92.00		MU 19	FU 0138 - 1
UCF 306		1.1811	30.00	3.7402	95.00		MU 21	FU 0139 - 1
UCFC 206		1.1811	30.00	3.9370	100.00		MU 13	FU 0140 - 1
UELFC 206		1.1811	30.00	3.9370	100.00		MU 13	FU 0140 - 2
SAFC 206		1.1811	30.00	3.9370	100.00		MU 13	FU 0140 - 3
SBFC 206		1.1811	30.00	3.9370	100.00		MU 13	FU 0140 - 4
UKFC 207		1.1811	30.00	4.3307	110.00		MU 17	FU 0141 - 1
UCFT 206		1.1811	30.00	4.5866	116.50		MU 14	FU 0142 - 1
UELFT 206		1.1811	30.00	4.5866	116.50		MU 14	FU 0142 - 2
SAFT 206		1.1811	30.00	4.5866	116.50		MU 14	FU 0142 - 3
SBFT 206		1.1811	30.00	4.5866	116.50		MU 14	FU 0142 - 4
UCFL 206		1.1811	30.00	4.6063	117.00		MU 15	FU 0143 - 1
UELFL 206		1.1811	30.00	4.6063	117.00		MU 15	FU 0143 - 2
SAFL 206		1.1811	30.00	4.6063	117.00		MU 15	FU 0143 - 3
SBFL 206		1.1811	30.00	4.6063	117.00		MU 15	FU 0143 - 4
UKFL 207		1.1811	30.00	5.1181	130.00		MU 18	FU 0144 - 1
UCFL X06		1.1811	30.00	5.1181	130.00		MU 20	FU 0145 - 1
UCFL 306		1.1811	30.00	5.2756	134.00		MU 22	FU 0146 - 1
UCFS 206 - 19		1.1875	30.16	3.2480	82.50		MU 11	FU 0147 - 1
UELFS 206 - 19		1.1875	30.16	3.2480	82.50		MU 11	FU 0147 - 2
SAFS 206 - 19		1.1875	30.16	3.2480	82.50		MU 11	FU 0147 - 3
SBFS 206 - 19		1.1875	30.16	3.2480	82.50		MU 11	FU 0147 - 4
UCF 206 - 19		1.1875	30.16	3.2677	83.00		MU 12	FU 0148 - 1
UELF 206 - 19		1.1875	30.16	3.2677	83.00		MU 12	FU 0148 - 2
SAF 206 - 19		1.1875	30.16	3.2677	83.00		MU 12	FU 0148 - 3
SBF 206 - 19		1.1875	30.16	3.2677	83.00		MU 12	FU 0148 - 4
SAPF 206 - 19		1.1875	30.16	3.5630	90.50		MU 09	FU 0149 - 1
SBPF 206 - 19		1.1875	30.16	3.5630	90.50		MU 09	FU 0149 - 2

DIMENSIONS

FLANGED UNITS DIMENSIONS

HYC	Number	ID		SB		Graphic	Figure No.	Group No.
		in	mm	in	mm			
SAPFL	206 - 19	1.1875	30.16	3.5630	90.50		MU 10	FU 0150 - 1
SBPFL	206 - 19	1.1875	30.16	3.5630	90.50		MU 10	FU 0150 - 2
UCF	X06 - 19	1.1875	30.16	3.6220	92.00		MU 19	FU 0151 - 1
UCF	306 - 19	1.1875	30.16	3.7402	95.00		MU 21	FU 0152 - 1
UCFC	206 - 19	1.1875	30.16	3.9370	100.00		MU 13	FU 0153 - 1
UELFC	206 - 19	1.1875	30.16	3.9370	100.00		MU 13	FU 0153 - 2
SAFC	206 - 19	1.1875	30.16	3.9370	100.00		MU 13	FU 0153 - 3
SBFC	206 - 19	1.1875	30.16	3.9370	100.00		MU 13	FU 0153 - 4
UCFT	206 - 19	1.1875	30.16	4.5866	116.50		MU 14	FU 0154 - 1
UELFT	206 - 19	1.1875	30.16	4.5866	116.50		MU 14	FU 0154 - 2
SAFT	206 - 19	1.1875	30.16	4.5866	116.50		MU 14	FU 0154 - 3
SBFT	206 - 19	1.1875	30.16	4.5866	116.50		MU 14	FU 0154 - 4
UCFL	206 - 19	1.1875	30.16	4.6063	117.00		MU 15	FU 0155 - 1
UELFL	206 - 19	1.1875	30.16	4.6063	117.00		MU 15	FU 0155 - 2
SAFL	206 - 19	1.1875	30.16	4.6063	117.00		MU 15	FU 0155 - 3
SBFL	206 - 19	1.1875	30.16	4.6063	117.00		MU 15	FU 0155 - 4
UCFL	X06 - 19	1.1875	30.16	5.1181	130.00		MU 20	FU 0156 - 1
UCFL	306 - 19	1.1875	30.16	5.2756	134.00		MU 22	FU 0157 - 1
UCFS	206 - 20	1.2500	31.75	3.2480	82.50		MU 11	FU 0158 - 1
UELFS	206 - 20	1.2500	31.75	3.2480	82.50		MU 11	FU 0158 - 2
SAFS	206 - 20	1.2500	31.75	3.2480	82.50		MU 11	FU 0158 - 3
SBFS	206 - 20	1.2500	31.75	3.2480	82.50		MU 11	FU 0158 - 4
UCF	206 - 20	1.2500	31.75	3.2677	83.00		MU 12	FU 0159 - 1
UELF	206 - 20	1.2500	31.75	3.2677	83.00		MU 12	FU 0159 - 2
SAF	206 - 20	1.2500	31.75	3.2677	83.00		MU 12	FU 0159 - 3
SBF	206 - 20	1.2500	31.75	3.2677	83.00		MU 12	FU 0159 - 4
SAPF	206 - 20	1.2500	31.75	3.5630	90.50		MU 09	FU 0160 - 1
SBPF	206 - 20	1.2500	31.75	3.5630	90.50		MU 09	FU 0160 - 2
SAPFL	206 - 20	1.2500	31.75	3.5630	90.50		MU 10	FU 0161 - 1
SBPFL	206 - 20	1.2500	31.75	3.5630	90.50		MU 10	FU 0161 - 2
UCF	207 - 20	1.2500	31.75	3.6220	92.00		MU 12	FU 0162 - 1
UELF	207 - 20	1.2500	31.75	3.6220	92.00		MU 12	FU 0162 - 2
SAF	207 - 20	1.2500	31.75	3.6220	92.00		MU 12	FU 0162 - 3
SBF	207 - 20	1.2500	31.75	3.6220	92.00		MU 12	FU 0162 - 4
UCF	X06 - 20	1.2500	31.75	3.6220	92.00		MU 19	FU 0163 - 1
UCF	306 - 20	1.2500	31.75	3.7402	95.00		MU 21	FU 0164 - 1
SAPF	207 - 20	1.2500	31.75	3.9370	100.00		MU 09	FU 0165 - 1
SBPF	207 - 20	1.2500	31.75	3.9370	100.00		MU 09	FU 0165 - 2
SAPFL	207 - 20	1.2500	31.75	3.9370	100.00		MU 10	FU 0166 - 1
SBPFL	207 - 20	1.2500	31.75	3.9370	100.00		MU 10	FU 0166 - 2
UCFC	206 - 20	1.2500	31.75	3.9370	100.00		MU 13	FU 0167 - 1
UELFC	206 - 20	1.2500	31.75	3.9370	100.00		MU 13	FU 0167 - 2

FLANGED UNITS DIMENSIONS

HYC	Number	ID		SB		Graphic	Figure No.	Group No.
		in	mm	in	mm			
SAFC	206 - 20	1.2500	31.75	3.9370	100.00		MU 13	FU 0167 - 3
SBFC	206 - 20	1.2500	31.75	3.9370	100.00		MU 13	FU 0167 - 4
UCF	307 - 20	1.2500	31.75	3.9370	100.00		MU 21	FU 0168 - 1
UCF	X07 - 20	1.2500	31.75	3.9961	101.50		MU 19	FU 0169 - 1
UCFC	207 - 20	1.2500	31.75	4.3307	110.00		MU 13	FU 0170 - 1
UELFC	207 - 20	1.2500	31.75	4.3307	110.00		MU 13	FU 0170 - 2
SAFC	207 - 20	1.2500	31.75	4.3307	110.00		MU 13	FU 0170 - 3
SBFC	207 - 20	1.2500	31.75	4.3307	110.00		MU 13	FU 0170 - 4
UCFT	206 - 20	1.2500	31.75	4.5866	116.50		MU 14	FU 0171 - 1
UELFT	206 - 20	1.2500	31.75	4.5866	116.50		MU 14	FU 0171 - 2
SAFT	206 - 20	1.2500	31.75	4.5866	116.50		MU 14	FU 0171 - 3
SBFT	206 - 20	1.2500	31.75	4.5866	116.50		MU 14	FU 0171 - 4
UCFL	206 - 20	1.2500	31.75	4.6063	117.00		MU 15	FU 0172 - 1
UELFL	206 - 20	1.2500	31.75	4.6063	117.00		MU 15	FU 0172 - 2
SAFL	206 - 20	1.2500	31.75	4.6063	117.00		MU 15	FU 0172 - 3
SBFL	206 - 20	1.2500	31.75	4.6063	117.00		MU 15	FU 0172 - 4
UCFT	207 - 20	1.2500	31.75	5.1181	130.00		MU 14	FU 0173 - 1
UELFT	207 - 20	1.2500	31.75	5.1181	130.00		MU 14	FU 0173 - 2
SAFT	207 - 20	1.2500	31.75	5.1181	130.00		MU 14	FU 0173 - 3
SBFT	207 - 20	1.2500	31.75	5.1181	130.00		MU 14	FU 0173 - 4
UCFL	207 - 20	1.2500	31.75	5.1181	130.00		MU 15	FU 0174 - 1
UELFL	207 - 20	1.2500	31.75	5.1181	130.00		MU 15	FU 0174 - 2
SAFL	207 - 20	1.2500	31.75	5.1181	130.00		MU 15	FU 0174 - 3
SBFL	207 - 20	1.2500	31.75	5.1181	130.00		MU 15	FU 0174 - 4
UCFL	X06 - 20	1.2500	31.75	5.1181	130.00		MU 20	FU 0175 - 1
UCFL	306 - 20	1.2500	31.75	5.2756	134.00		MU 22	FU 0176 - 1
UCFL	307 - 20	1.2500	31.75	5.5512	141.00		MU 22	FU 0177 - 1
UCFL	X07 - 20	1.2500	31.75	5.6693	144.00		MU 20	FU 0178 - 1
UCFS	207 - 20	1.2500	31.75	3.6220	92.0		MU 11	FU 0179 - 1
UELFS	207 - 20	1.2500	31.75	3.6220	92.0		MU 11	FU 0179 - 2
SAFS	207 - 20	1.2500	31.75	3.6220	92.0		MU 11	FU 0179 - 3
SBFS	207 - 20	1.2500	31.75	3.6220	92.0		MU 11	FU 0179 - 4
UCF	207 - 21	1.3125	33.34	3.6220	92.00		MU 12	FU 0180 - 1
UELF	207 - 21	1.3125	33.34	3.6220	92.00		MU 12	FU 0180 - 2
SAF	207 - 21	1.3125	33.34	3.6220	92.00		MU 12	FU 0180 - 3
SBF	207 - 21	1.3125	33.34	3.6220	92.00		MU 12	FU 0180 - 4
SAPF	207 - 21	1.3125	33.34	3.9370	100.00		MU 09	FU 0181 - 1
SBPF	207 - 21	1.3125	33.34	3.9370	100.00		MU 09	FU 0181 - 2
SAPFL	207 - 21	1.3125	33.34	3.9370	100.00		MU 10	FU 0182 - 1
SBPFL	207 - 21	1.3125	33.34	3.9370	100.00		MU 10	FU 0182 - 2
UCF	307 - 21	1.3125	33.34	3.9370	100.00		MU 21	FU 0183 - 1
UCF	X07 - 21	1.3125	33.34	3.9961	101.50		MU 19	FU 0184 - 1

DIMENSIONS

FLANGED UNITS DIMENSIONS











































HYC	Number	ID		SB		Graphic	Figure No.	Group No.
		in	mm	in	mm			
UCFC	207 - 21	1.3125	33.34	4.3307	110.00		MU 13	FU 0185 - 1
UELFC	207 - 21	1.3125	33.34	4.3307	110.00		MU 13	FU 0185 - 2
SBFC	207 - 21	1.3125	33.34	4.3307	110.00		MU 13	FU 0185 - 3
UCFT	207 - 21	1.3125	33.34	5.1181	130.00		MU 14	FU 0186 - 1
UELFT	207 - 21	1.3125	33.34	5.1181	130.00		MU 14	FU 0186 - 2
SAFT	207 - 21	1.3125	33.34	5.1181	130.00		MU 14	FU 0186 - 3
UCFL	207 - 21	1.3125	33.34	5.1181	130.00		MU 15	FU 0187 - 1
UELFL	207 - 21	1.3125	33.34	5.1181	130.00		MU 15	FU 0187 - 2
SAFL	207 - 21	1.3125	33.34	5.1181	130.00		MU 15	FU 0187 - 3
SBFL	207 - 21	1.3125	33.34	5.1181	130.00		MU 15	FU 0187 - 4
UCFL	307 - 21	1.3125	33.34	5.5512	141.00		MU 22	FU 0188 - 1
UCFL	X07 - 21	1.3125	33.34	5.6693	144.00		MU 20	FU 0189 - 1
UCFS	207 - 21	1.3125	33.34	3.6220	92.0		MU 11	FU 0190 - 1
UELFS	207 - 21	1.3125	33.34	3.6220	92.0		MU 11	FU 0190 - 2
SAFS	207 - 21	1.3125	33.34	3.6220	92.0		MU 11	FU 0190 - 3
UCF	207 - 22	1.3750	34.93	3.6220	92.00		MU 12	FU 0191 - 1
UELF	207 - 22	1.3750	34.93	3.6220	92.00		MU 12	FU 0191 - 2
SAF	207 - 22	1.3750	34.93	3.6220	92.00		MU 12	FU 0191 - 3
SBF	207 - 22	1.3750	34.93	3.6220	92.00		MU 12	FU 0191 - 4
SAPF	207 - 22	1.3750	34.93	3.9370	100.00		MU 09	FU 0192 - 1
SBPF	207 - 22	1.3750	34.93	3.9370	100.00		MU 09	FU 0192 - 2
SAPFL	207 - 22	1.3750	34.93	3.9370	100.00		MU 10	FU 0193 - 1
SBPFL	207 - 22	1.3750	34.93	3.9370	100.00		MU 10	FU 0193 - 2
UCF	307 - 22	1.3750	34.93	3.9370	100.00		MU 21	FU 0194 - 1
UCF	X07 - 22	1.3750	34.93	3.9961	101.50		MU 19	FU 0195 - 1
UCFC	207 - 22	1.3750	34.93	4.3307	110.00		MU 13	FU 0196 - 1
UELFC	207 - 22	1.3750	34.93	4.3307	110.00		MU 13	FU 0196 - 2
SAFC	207 - 22	1.3750	34.93	4.3307	110.00		MU 13	FU 0196 - 3
SBFC	207 - 22	1.3750	34.93	4.3307	110.00		MU 13	FU 0196 - 4
UCFT	207 - 22	1.3750	34.93	5.1181	130.00		MU 14	FU 0197 - 1
UELFT	207 - 22	1.3750	34.93	5.1181	130.00		MU 14	FU 0197 - 2
SAFT	207 - 22	1.3750	34.93	5.1181	130.00		MU 14	FU 0197 - 3
SBFT	207 - 22	1.3750	34.93	5.1181	130.00		MU 14	FU 0197 - 4
UCFL	207 - 22	1.3750	34.93	5.1181	130.00		MU 15	FU 0198 - 1
UELFL	207 - 22	1.3750	34.93	5.1181	130.00		MU 15	FU 0198 - 2
SAFL	207 - 22	1.3750	34.93	5.1181	130.00		MU 15	FU 0198 - 3
SBFL	207 - 22	1.3750	34.93	5.1181	130.00		MU 15	FU 0198 - 4
UCFL	307 - 22	1.3750	34.93	5.5512	141.00		MU 22	FU 0199 - 1
UCFL	X07 - 22	1.3750	34.93	5.6693	144.00		MU 20	FU 0200 - 1
UCFS	207 - 22	1.3750	34.93	3.6220	92.0		MU 11	FU 0201 - 1
UELFS	207 - 22	1.3750	34.93	3.6220	92.0		MU 11	FU 0201 - 2
SAFS	207 - 22	1.3750	34.93	3.6220	92.0		MU 11	FU 0201 - 3

FLANGED UNITS DIMENSIONS

HYC	Number	ID		SB		Graphic	Figure No.	Group No.
		in	mm	in	mm			
SBFS	207 - 22	1.3750	34.93	3.6220	92.0		MU 11	FU 0201 - 4
UCF	207	1.3780	35.00	3.6220	92.00		MU 12	FU 0202 - 1
UELF	207	1.3780	35.00	3.6220	92.00		MU 12	FU 0202 - 2
SAF	207	1.3780	35.00	3.6220	92.00		MU 12	FU 0202 - 3
SBF	207	1.3780	35.00	3.6220	92.00		MU 12	FU 0202 - 4
SAPF	207	1.3780	35.00	3.9370	100.00		MU 09	FU 0203 - 1
SBPF	207	1.3780	35.00	3.9370	100.00		MU 09	FU 0203 - 2
SAPFL	207	1.3780	35.00	3.9370	100.00		MU 10	FU 0204 - 1
SBPFL	207	1.3780	35.00	3.9370	100.00		MU 10	FU 0204 - 2
UCF	307	1.3780	35.00	3.9370	100.00		MU 21	FU 0205 - 1
UCF	X07	1.3780	35.00	3.9961	101.50		MU 19	FU 0206 - 1
UKF	208	1.3780	35.00	4.0157	102.00		MU 16	FU 0207 - 1
UCFC	207	1.3780	35.00	4.3307	110.00		MU 13	FU 0208 - 1
UELFC	207	1.3780	35.00	4.3307	110.00		MU 13	FU 0208 - 2
SAFC	207	1.3780	35.00	4.3307	110.00		MU 13	FU 0208 - 3
SBFC	207	1.3780	35.00	4.3307	110.00		MU 13	FU 0208 - 4
UKFC	208	1.3780	35.00	4.7244	120.00		MU 17	FU 0209 - 1
UCFT	207	1.3780	35.00	5.1181	130.00		MU 14	FU 0210 - 1
UELFT	207	1.3780	35.00	5.1181	130.00		MU 14	FU 0210 - 2
SAFT	207	1.3780	35.00	5.1181	130.00		MU 14	FU 0210 - 3
SBFT	207	1.3780	35.00	5.1181	130.00		MU 14	FU 0210 - 4
UCFL	207	1.3780	35.00	5.1181	130.00		MU 15	FU 0211 - 1
UELFL	207	1.3780	35.00	5.1181	130.00		MU 15	FU 0211 - 2
SAFL	207	1.3780	35.00	5.1181	130.00		MU 15	FU 0211 - 3
SBFL	207	1.3780	35.00	5.1181	130.00		MU 15	FU 0211 - 4
UCFL	307	1.3780	35.00	5.5512	141.00		MU 22	FU 0212 - 1
UKFL	208	1.3780	35.00	5.6693	144.00		MU 18	FU 0213 - 1
UCFL	X07	1.3780	35.00	5.6693	144.00		MU 20	FU 0214 - 1
UCFS	207	1.3780	35.00	3.6220	92.0		MU 11	FU 0215 - 1
UELFS	207	1.3780	35.00	3.6220	92.0		MU 11	FU 0215 - 2
SAFS	207	1.3780	35.00	3.6220	92.0		MU 11	FU 0215 - 3
SBFS	207	1.3780	35.00	3.6220	92.0		MU 11	FU 0215 - 4
UCF	207 - 23	1.4375	36.51	3.6220	92.00		MU 12	FU 0216 - 1
UELF	207 - 23	1.4375	36.51	3.6220	92.00		MU 12	FU 0216 - 2
SAF	207 - 23	1.4375	36.51	3.6220	92.00		MU 12	FU 0216 - 3
SBF	207 - 23	1.4375	36.51	3.6220	92.00		MU 12	FU 0216 - 4
SAPF	207 - 23	1.4375	36.51	3.9370	100.00		MU 09	FU 0217 - 1
SBPF	207 - 23	1.4375	36.51	3.9370	100.00		MU 09	FU 0217 - 2
SAPFL	207 - 23	1.4375	36.51	3.9370	100.00		MU 10	FU 0218 - 1
SBPFL	207 - 23	1.4375	36.51	3.9370	100.00		MU 10	FU 0218 - 2
UCF	307 - 23	1.4375	36.51	3.9370	100.00		MU 21	FU 0219 - 1
UCF	X07 - 23	1.4375	36.51	3.9961	101.50		MU 19	FU 0220 - 1

DIMENSIONS

FLANGED UNITS DIMENSIONS











































HYC	Number	ID		SB		Graphic	Figure No.	Group No.
		in	mm	in	mm			
UCFC	207 - 23	1.4375	36.51	4.3307	110.00		MU 13	FU 0221 - 1
UELFC	207 - 23	1.4375	36.51	4.3307	110.00		MU 13	FU 0221 - 2
SAFC	207 - 23	1.4375	36.51	4.3307	110.00		MU 13	FU 0221 - 3
SBFC	207 - 23	1.4375	36.51	4.3307	110.00		MU 13	FU 0221 - 4
UCFT	207 - 23	1.4375	36.51	5.1181	130.00		MU 14	FU 0222 - 1
UELFT	207 - 23	1.4375	36.51	5.1181	130.00		MU 14	FU 0222 - 2
SAFT	207 - 23	1.4375	36.51	5.1181	130.00		MU 14	FU 0222 - 3
SBFT	207 - 23	1.4375	36.51	5.1181	130.00		MU 14	FU 0222 - 4
UCFL	207 - 23	1.4375	36.51	5.1181	130.00		MU 15	FU 0223 - 1
UELFL	207 - 23	1.4375	36.51	5.1181	130.00		MU 15	FU 0223 - 2
SAFL	207 - 23	1.4375	36.51	5.1181	130.00		MU 15	FU 0223 - 3
SBFL	207 - 23	1.4375	36.51	5.1181	130.00		MU 15	FU 0223 - 4
UCFL	307 - 23	1.4375	36.51	5.5512	141.00		MU 22	FU 0224 - 1
UCFL	X07 - 23	1.4375	36.51	5.6693	144.00		MU 20	FU 0225 - 1
UCFS	207 - 23	1.4375	36.51	3.6220	92.0		MU 11	FU 0226 - 1
UELFS	207 - 23	1.4375	36.51	3.6220	92.0		MU 11	FU 0226 - 2
SAFS	207 - 23	1.4375	36.51	3.6220	92.0		MU 11	FU 0226 - 3
SBFS	207 - 23	1.4375	36.51	3.6220	92.0		MU 11	FU 0226 - 4
UCFS	208 - 24	1.5000	38.10	3.9961	101.50		MU 11	FU 0227 - 1
UELFS	208 - 24	1.5000	38.10	3.9961	101.50		MU 11	FU 0227 - 2
SAFS	208 - 24	1.5000	38.10	3.9961	101.50		MU 11	FU 0227 - 3
SBFS	208 - 24	1.5000	38.10	3.9961	101.50		MU 11	FU 0227 - 4
UCF	208 - 24	1.5000	38.10	4.0157	102.00		MU 12	FU 0228 - 1
UELF	208 - 24	1.5000	38.10	4.0157	102.00		MU 12	FU 0228 - 2
SAF	208 - 24	1.5000	38.10	4.0157	102.00		MU 12	FU 0228 - 3
UCF	X08 - 24	1.5000	38.10	4.1339	105.00		MU 19	FU 0229 - 1
UCF	308 - 24	1.5000	38.10	4.4094	112.00		MU 21	FU 0230 - 1
UCFC	208 - 24	1.5000	38.10	4.7244	120.00		MU 13	FU 0231 - 1
UELFC	208 - 24	1.5000	38.10	4.7244	120.00		MU 13	FU 0231 - 2
SAFC	208 - 24	1.5000	38.10	4.7244	120.00		MU 13	FU 0231 - 3
SBFC	208 - 24	1.5000	38.10	4.7244	120.00		MU 13	FU 0231 - 4
UCFT	208 - 24	1.5000	38.10	5.6496	143.50		MU 14	FU 0232 - 1
UELFT	208 - 24	1.5000	38.10	5.6496	143.50		MU 14	FU 0232 - 2
SAFT	208 - 24	1.5000	38.10	5.6496	143.50		MU 14	FU 0232 - 3
SBFT	208 - 24	1.5000	38.10	5.6496	143.50		MU 14	FU 0232 - 4
UCFL	208 - 24	1.5000	38.10	5.6693	144.00		MU 15	FU 0233 - 1
UELFL	208 - 24	1.5000	38.10	5.6693	144.00		MU 15	FU 0233 - 2
SAFL	208 - 24	1.5000	38.10	5.6693	144.00		MU 15	FU 0233 - 3
UCFL	X08 - 24	1.5000	38.10	5.8268	148.00		MU 20	FU 0234 - 1
UCFL	308 - 24	1.5000	38.10	6.2205	158.00		MU 22	FU 0235 - 1
UCFS	208 - 25	1.5625	39.69	3.9961	101.50		MU 11	FU 0236 - 1
UELFS	208 - 25	1.5625	39.69	3.9961	101.50		MU 11	FU 0236 - 2

FLANGED UNITS DIMENSIONS











































HYC	Number	ID		SB		Graphic	Figure No.	Group No.
		in	mm	in	mm			
UCFL 308		1.5748	40.00	6.2205	158.00		MU 22	FU 0256 - 1
UCF 209 - 26		1.6250	41.28	4.1339	105.00		MU 12	FU 0257 - 1
UELF 209 - 26		1.6250	41.28	4.1339	105.00		MU 12	FU 0257 - 2
SAF 209 - 26		1.6250	41.28	4.1339	105.00		MU 12	FU 0257 - 3
UCF X09 - 26		1.6250	41.28	4.3701	111.00		MU 19	FU 0258 - 1
UCF 309 - 26		1.6250	41.28	4.9213	125.00		MU 21	FU 0259 - 1
UCFC 209 - 26		1.6250	41.28	5.1969	132.00		MU 13	FU 0260 - 1
UELFC 209 - 26		1.6250	41.28	5.1969	132.00		MU 13	FU 0260 - 2
SAFC 209 - 26		1.6250	41.28	5.1969	132.00		MU 13	FU 0260 - 3
UCFL 209 - 26		1.6250	41.28	5.8268	148.00		MU 15	FU 0261 - 1
UELFL 209 - 26		1.6250	41.28	5.8268	148.00		MU 15	FU 0261 - 2
SAFL 209 - 26		1.6250	41.28	5.8268	148.00		MU 15	FU 0261 - 3
UCFT 209 - 26		1.6250	41.28	5.8465	148.50		MU 14	FU 0262 - 1
UELFT 209 - 26		1.6250	41.28	5.8465	148.50		MU 14	FU 0262 - 2
SAFT 209 - 26		1.6250	41.28	5.8465	148.50		MU 14	FU 0262 - 3
UCFL X09 - 26		1.6250	41.28	6.1811	157.00		MU 20	FU 0263 - 1
UCFL 309 - 26		1.6250	41.28	6.9685	177.00		MU 22	FU 0264 - 1
UCFS 209 - 26		1.6250	41.28	4.1339	105.0		MU 11	FU 0265 - 1
UELFS 209 - 26		1.6250	41.28	4.1339	105.0		MU 11	FU 0265 - 2
SAFS 209 - 26		1.6250	41.28	4.1339	105.0		MU 11	FU 0265 - 3
UCF 209 - 27		1.6875	42.86	4.1339	105.00		MU 12	FU 0266 - 1
UELF 209 - 27		1.6875	42.86	4.1339	105.00		MU 12	FU 0266 - 2
SAF 209 - 27		1.6875	42.86	4.1339	105.00		MU 12	FU 0266 - 3
UCF X09 - 27		1.6875	42.86	4.3701	111.00		MU 19	FU 0267 - 1
UCF 309 - 27		1.6875	42.86	4.9213	125.00		MU 21	FU 0268 - 1
UCFC 209 - 27		1.6875	42.86	5.1969	132.00		MU 13	FU 0269 - 1
UELFC 209 - 27		1.6875	42.86	5.1969	132.00		MU 13	FU 0269 - 2
SAFC 209 - 27		1.6875	42.86	5.1969	132.00		MU 13	FU 0269 - 3
UCFL 209 - 27		1.6875	42.86	5.8268	148.00		MU 15	FU 0270 - 1
UELFL 209 - 27		1.6875	42.86	5.8268	148.00		MU 15	FU 0270 - 2
SAFL 209 - 27		1.6875	42.86	5.8268	148.00		MU 15	FU 0270 - 3
UCFT 209 - 27		1.6875	42.86	5.8465	148.50		MU 14	FU 0271 - 1
UELFT 209 - 27		1.6875	42.86	5.8465	148.50		MU 14	FU 0271 - 2
SAFT 209 - 27		1.6875	42.86	5.8465	148.50		MU 14	FU 0271 - 3
UCFL X09 - 27		1.6875	42.86	6.1811	157.00		MU 20	FU 0272 - 1
UCFL 309 - 27		1.6875	42.86	6.9685	177.00		MU 22	FU 0273 - 1
UCFS 209 - 27		1.6875	42.86	4.1339	105.0		MU 11	FU 0274 - 1
UELFS 209 - 27		1.6875	42.86	4.1339	105.0		MU 11	FU 0274 - 2
SAFS 209 - 27		1.6875	42.86	4.1339	105.0		MU 11	FU 0274 - 3
UCF 209 - 28		1.7500	44.45	4.1339	105.00		MU 12	FU 0275 - 1
UELF 209 - 28		1.7500	44.45	4.1339	105.00		MU 12	FU 0275 - 2
SAF 209 - 28		1.7500	44.45	4.1339	105.00		MU 12	FU 0275 - 3

DIMENSIONS

FLANGED UNITS DIMENSIONS











































HYC	Number	ID		SB		Graphic	Figure No.	Group No.
		in	mm	in	mm			
UCF X09 - 28		1.7500	44.45	4.3701	111.00		MU 19	FU 0276 - 1
UCF 309 - 28		1.7500	44.45	4.9213	125.00		MU 21	FU 0277 - 1
UCFC 209 - 28		1.7500	44.45	5.1969	132.00		MU 13	FU 0278 - 1
UELFC 209 - 28		1.7500	44.45	5.1969	132.00		MU 13	FU 0278 - 2
SAFC 209 - 28		1.7500	44.45	5.1969	132.00		MU 13	FU 0278 - 3
UCFL 209 - 28		1.7500	44.45	5.8268	148.00		MU 15	FU 0279 - 1
UELFL 209 - 28		1.7500	44.45	5.8268	148.00		MU 15	FU 0279 - 2
SAFL 209 - 28		1.7500	44.45	5.8268	148.00		MU 15	FU 0279 - 3
UCFT 209 - 28		1.7500	44.45	5.8465	148.50		MU 14	FU 0280 - 1
UELFT 209 - 28		1.7500	44.45	5.8465	148.50		MU 14	FU 0280 - 2
SAFT 209 - 28		1.7500	44.45	5.8465	148.50		MU 14	FU 0280 - 3
UCFL X09 - 28		1.7500	44.45	6.1811	157.00		MU 20	FU 0281 - 1
UCFL 309 - 28		1.7500	44.45	6.9685	177.00		MU 22	FU 0282 - 1
UCFS 209 - 28		1.7500	44.45	4.1339	105.0		MU 11	FU 0283 - 1
UELFS 209 - 28		1.7500	44.45	4.1339	105.0		MU 11	FU 0283 - 2
SAFS 209 - 28		1.7500	44.45	4.1339	105.0		MU 11	FU 0283 - 3
UCF 209		1.7717	45.00	4.1339	105.00		MU 12	FU 0284 - 1
UELF 209		1.7717	45.00	4.1339	105.00		MU 12	FU 0284 - 2
SAF 209		1.7717	45.00	4.1339	105.00		MU 12	FU 0284 - 3
UKF 210		1.7717	45.00	4.3701	111.00		MU 16	FU 0285 - 1
UCF X09		1.7717	45.00	4.3701	111.00		MU 19	FU 0286 - 1
UCF 309		1.7717	45.00	4.9213	125.00		MU 21	FU 0287 - 1
UCFC 209		1.7717	45.00	5.1969	132.00		MU 13	FU 0288 - 1
UELFC 209		1.7717	45.00	5.1969	132.00		MU 13	FU 0288 - 2
SAFC 209		1.7717	45.00	5.1969	132.00		MU 13	FU 0288 - 3
UKFC 210		1.7717	45.00	5.4331	138.00		MU 17	FU 0289 - 1
UCFL 209		1.7717	45.00	5.8268	148.00		MU 15	FU 0290 - 1
UELFL 209		1.7717	45.00	5.8268	148.00		MU 15	FU 0290 - 2
SAFL 209		1.7717	45.00	5.8268	148.00		MU 15	FU 0290 - 3
UCFT 209		1.7717	45.00	5.8465	148.50		MU 14	FU 0291 - 1
UELFT 209		1.7717	45.00	5.8465	148.50		MU 14	FU 0291 - 2
SAFT 209		1.7717	45.00	5.8465	148.50		MU 14	FU 0291 - 3
UKFL 210		1.7717	45.00	6.1811	157.00		MU 18	FU 0292 - 1
UCFL X09		1.7717	45.00	6.1811	157.00		MU 20	FU 0293 - 1
UCFL 309		1.7717	45.00	6.9685	177.00		MU 22	FU 0294 - 1
UCFS 209		1.7717	45.00	4.1339	105.0		MU 11	FU 0295 - 1
UELFS 209		1.7717	45.00	4.1339	105.0		MU 11	FU 0295 - 2
SAFS 209		1.7717	45.00	4.1339	105.0		MU 11	FU 0295 - 3
UCF 210 - 29		1.8125	46.04	4.3701	111.00		MU 12	FU 0296 - 1
UELF 210 - 29		1.8125	46.04	4.3701	111.00		MU 12	FU 0296 - 2
UCF X10 - 29		1.8125	46.04	5.1181	130.00		MU 19	FU 0297 - 1
UCF 310 - 29		1.8125	46.04	5.1969	132.00		MU 21	FU 0298 - 1

FLANGED UNITS DIMENSIONS











































HYC	Number	ID		SB		Graphic	Figure No.	Group No.
		in	mm	in	mm			
UCFC	210 - 29	1.8125	46.04	5.4331	138.00		MU 13	FU 0299 - 1
UELFC	210 - 29	1.8125	46.04	5.4331	138.00		MU 13	FU 0299 - 2
UCFT	210 - 29	1.8125	46.04	6.1811	157.00		MU 14	FU 0300 - 1
UELFT	210 - 29	1.8125	46.04	6.1811	157.00		MU 14	FU 0300 - 2
SAFT	210 - 29	1.8125	46.04	6.1811	157.00		MU 14	FU 0300 - 3
UCFL	210 - 29	1.8125	46.04	6.1811	157.00		MU 15	FU 0301 - 1
UELFL	210 - 29	1.8125	46.04	6.1811	157.00		MU 15	FU 0301 - 2
UCFL	X10 - 29	1.8125	46.04	7.2441	184.00		MU 20	FU 0302 - 1
UCFL	310 - 29	1.8125	46.04	7.3622	187.00		MU 22	FU 0303 - 1
UCFS	210 - 29	1.8125	46.04	4.3701	111.0		MU 11	FU 0304 - 1
UELFS	210 - 29	1.8125	46.04	4.3701	111.0		MU 11	FU 0304 - 2
SAFS	210 - 29	1.8125	46.04	4.3701	111.0		MU 11	FU 0304 - 3
UCF	210 - 30	1.8750	47.63	4.3701	111.00		MU 12	FU 0305 - 1
UELF	210 - 30	1.8750	47.63	4.3701	111.00		MU 12	FU 0305 - 2
SAF	210 - 30	1.8750	47.63	4.3701	111.00		MU 12	FU 0305 - 3
UCF	X10 - 30	1.8750	47.63	5.1181	130.00		MU 19	FU 0306 - 1
UCF	310 - 30	1.8750	47.63	5.1969	132.00		MU 21	FU 0307 - 1
UCFC	210 - 30	1.8750	47.63	5.4331	138.00		MU 13	FU 0308 - 1
UELFC	210 - 30	1.8750	47.63	5.4331	138.00		MU 13	FU 0308 - 2
SAFC	210 - 30	1.8750	47.63	5.4331	138.00		MU 13	FU 0308 - 3
UCFT	210 - 30	1.8750	47.63	6.1811	157.00		MU 14	FU 0309 - 1
UELFT	210 - 30	1.8750	47.63	6.1811	157.00		MU 14	FU 0309 - 2
SAFT	210 - 30	1.8750	47.63	6.1811	157.00		MU 14	FU 0309 - 3
UCFL	210 - 30	1.8750	47.63	6.1811	157.00		MU 15	FU 0310 - 1
UELFL	210 - 30	1.8750	47.63	6.1811	157.00		MU 15	FU 0310 - 2
SAFL	210 - 30	1.8750	47.63	6.1811	157.00		MU 15	FU 0310 - 3
UCFL	X10 - 30	1.8750	47.63	7.2441	184.00		MU 20	FU 0311 - 1
UCFL	310 - 30	1.8750	47.63	7.3622	187.00		MU 22	FU 0312 - 1
UCFS	210 - 30	1.8750	47.63	4.3701	111.0		MU 11	FU 0313 - 1
UELFS	210 - 30	1.8750	47.63	4.3701	111.0		MU 11	FU 0313 - 2
SAFS	210 - 30	1.8750	47.63	4.3701	111.0		MU 11	FU 0313 - 3
UCF	210 - 31	1.9375	49.21	4.3701	111.00		MU 12	FU 0314 - 1
UELF	210 - 31	1.9375	49.21	4.3701	111.00		MU 12	FU 0314 - 2
SAF	210 - 31	1.9375	49.21	4.3701	111.00		MU 12	FU 0314 - 3
UCF	X10 - 31	1.9375	49.21	5.1181	130.00		MU 19	FU 0315 - 1
UCF	310 - 31	1.9375	49.21	5.1969	132.00		MU 21	FU 0316 - 1
UCFC	210 - 31	1.9375	49.21	5.4331	138.00		MU 13	FU 0317 - 1
UELFC	210 - 31	1.9375	49.21	5.4331	138.00		MU 13	FU 0317 - 2
SAFC	210 - 31	1.9375	49.21	5.4331	138.00		MU 13	FU 0317 - 3
UCFT	210 - 31	1.9375	49.21	6.1811	157.00		MU 14	FU 0318 - 1
UELFT	210 - 31	1.9375	49.21	6.1811	157.00		MU 14	FU 0318 - 2
SAFT	210 - 31	1.9375	49.21	6.1811	157.00		MU 14	FU 0318 - 3

DIMENSIONS

FLANGED UNITS DIMENSIONS

HYC	Number	ID		SB		Graphic	Figure No.	Group No.
		in	mm	in	mm			
UCFL 210 - 31		1.9375	49.21	6.1811	157.00		MU 15	FU 0319 - 1
UELFL 210 - 31		1.9375	49.21	6.1811	157.00		MU 15	FU 0319 - 2
SAFL 210 - 31		1.9375	49.21	6.1811	157.00		MU 15	FU 0319 - 3
UCFL X10 - 31		1.9375	49.21	7.2441	184.00		MU 20	FU 0320 - 1
UCFL 310 - 31		1.9375	49.21	7.3622	187.00		MU 22	FU 0321 - 1
UCFS 210 - 31		1.9375	49.21	4.3701	111.0		MU 11	FU 0322 - 1
UELFS 210 - 31		1.9375	49.21	4.3701	111.0		MU 11	FU 0322 - 2
SAFS 210 - 31		1.9375	49.21	4.3701	111.0		MU 11	FU 0322 - 3
UCF 210		1.9685	50.00	4.3701	111.00		MU 12	FU 0323 - 1
UELF 210		1.9685	50.00	4.3701	111.00		MU 12	FU 0323 - 2
SAF 210		1.9685	50.00	4.3701	111.00		MU 12	FU 0323 - 3
UKF 211		1.9685	50.00	5.1181	130.00		MU 16	FU 0324 - 1
UCF X10		1.9685	50.00	5.1181	130.00		MU 19	FU 0325 - 1
UCF 310		1.9685	50.00	5.1969	132.00		MU 21	FU 0326 - 1
UCFC 210		1.9685	50.00	5.4331	138.00		MU 13	FU 0327 - 1
UELFC 210		1.9685	50.00	5.4331	138.00		MU 13	FU 0327 - 2
SAFC 210		1.9685	50.00	5.4331	138.00		MU 13	FU 0327 - 3
UKFC 211		1.9685	50.00	5.9055	150.00		MU 17	FU 0328 - 1
UCFT 210		1.9685	50.00	6.1811	157.00		MU 14	FU 0329 - 1
UELFT 210		1.9685	50.00	6.1811	157.00		MU 14	FU 0329 - 2
SAFT 210		1.9685	50.00	6.1811	157.00		MU 14	FU 0329 - 3
UCFL 210		1.9685	50.00	6.1811	157.00		MU 15	FU 0330 - 1
UELFL 210		1.9685	50.00	6.1811	157.00		MU 15	FU 0330 - 2
SAFL 210		1.9685	50.00	6.1811	157.00		MU 15	FU 0330 - 3
UKFL 211		1.9685	50.00	7.2441	184.00		MU 18	FU 0331 - 1
UCFL X10		1.9685	50.00	7.2441	184.00		MU 20	FU 0332 - 1
UCFL 310		1.9685	50.00	7.3622	187.00		MU 22	FU 0333 - 1
UCFS 210		1.9685	50.00	4.3701	111.0		MU 11	FU 0334 - 1
UELFS 210		1.9685	50.00	4.3701	111.0		MU 11	FU 0334 - 2
SAFS 210		1.9685	50.00	4.3701	111.0		MU 11	FU 0334 - 3
UCF 210 - 32		2.0000	50.80	4.3701	111.00		MU 12	FU 0335 - 1
UELF 210 - 32		2.0000	50.80	4.3701	111.00		MU 12	FU 0335 - 2
UCF 211 - 32		2.0000	50.80	5.1181	130.00		MU 12	FU 0336 - 1
UELF 211 - 32		2.0000	50.80	5.1181	130.00		MU 12	FU 0336 - 2
SAF 211 - 32		2.0000	50.80	5.1181	130.00		MU 12	FU 0336 - 3
UCF X10 - 32		2.0000	50.80	5.1181	130.00		MU 19	FU 0337 - 1
UCF 310 - 32		2.0000	50.80	5.1969	132.00		MU 21	FU 0338 - 1
UCFC 210 - 32		2.0000	50.80	5.4331	138.00		MU 13	FU 0339 - 1
UELFC 210 - 32		2.0000	50.80	5.4331	138.00		MU 13	FU 0339 - 2
UCF 311 - 32		2.0000	50.80	5.5118	140.00		MU 21	FU 0340 - 1
UCF X11 - 32		2.0000	50.80	5.6299	143.00		MU 19	FU 0341 - 1
UCFC 211 - 32		2.0000	50.80	5.9055	150.00		MU 13	FU 0342 - 1

FLANGED UNITS DIMENSIONS

HYC	Number	ID		SB		Graphic	Figure No.	Group No.
		in	mm	in	mm			
UELFC	211 - 32	2.0000	50.80	5.9055	150.00		MU 13	FU 0342 - 2
UCFT	210 - 32	2.0000	50.80	6.1811	157.00		MU 14	FU 0343 - 1
UELFT	210 - 32	2.0000	50.80	6.1811	157.00		MU 14	FU 0343 - 2
SAFT	210 - 32	2.0000	50.80	6.1811	157.00		MU 14	FU 0343 - 3
UCFL	210 - 32	2.0000	50.80	6.1811	157.00		MU 15	FU 0344 - 1
UELFL	210 - 32	2.0000	50.80	6.1811	157.00		MU 15	FU 0344 - 2
UCFT	211 - 32	2.0000	50.80	7.2441	184.00		MU 14	FU 0345 - 1
UELFT	211 - 32	2.0000	50.80	7.2441	184.00		MU 14	FU 0345 - 2
SAFT	211 - 32	2.0000	50.80	7.2441	184.00		MU 14	FU 0345 - 3
UCFL	211 - 32	2.0000	50.80	7.2441	184.00		MU 15	FU 0346 - 1
UELFL	211 - 32	2.0000	50.80	7.2441	184.00		MU 15	FU 0346 - 2
SAFL	211 - 32	2.0000	50.80	7.2441	184.00		MU 15	FU 0346 - 3
UCFL	X10 - 32	2.0000	50.80	7.2441	184.00		MU 20	FU 0347 - 1
UCFL	310 - 32	2.0000	50.80	7.3622	187.00		MU 22	FU 0348 - 1
UCFL	311 - 32	2.0000	50.80	7.7953	198.00		MU 22	FU 0349 - 1
UCFS	210 - 32	2.0000	50.80	4.3701	111.0		MU 11	FU 0350 - 1
UELFS	210 - 32	2.0000	50.80	4.3701	111.0		MU 11	FU 0350 - 2
SAFS	210 - 32	2.0000	50.80	4.3701	111.0		MU 11	FU 0350 - 3
UCFS	211 - 32	2.0000	50.80	5.1181	130.0		MU 11	FU 0351 - 1
UELFS	211 - 32	2.0000	50.80	5.1181	130.0		MU 11	FU 0351 - 2
SAFS	211 - 32	2.0000	50.80	5.1181	130.0		MU 11	FU 0351 - 3
UCF	211 - 33	2.0625	52.39	5.1181	130.00		MU 12	FU 0352 - 1
UELF	211 - 33	2.0625	52.39	5.1181	130.00		MU 12	FU 0352 - 2
UCF	311 - 33	2.0625	52.39	5.5118	140.00		MU 21	FU 0353 - 1
UCF	X11 - 33	2.0625	52.39	5.6299	143.00		MU 19	FU 0354 - 1
UCFC	211 - 33	2.0625	52.39	5.9055	150.00		MU 13	FU 0355 - 1
UELFC	211 - 33	2.0625	52.39	5.9055	150.00		MU 13	FU 0355 - 2
UCFT	211 - 33	2.0625	52.39	7.2441	184.00		MU 14	FU 0356 - 1
UELFT	211 - 33	2.0625	52.39	7.2441	184.00		MU 14	FU 0356 - 2
SAFT	211 - 33	2.0625	52.39	7.2441	184.00		MU 14	FU 0356 - 3
UCFL	211 - 33	2.0625	52.39	7.2441	184.00		MU 15	FU 0357 - 1
UELFL	211 - 33	2.0625	52.39	7.2441	184.00		MU 15	FU 0357 - 2
UCFL	311 - 33	2.0625	52.39	7.7953	198.00		MU 22	FU 0358 - 1
UCFS	211 - 33	2.0625	52.39	5.1181	130.0		MU 11	FU 0359 - 1
UELFS	211 - 33	2.0625	52.39	5.1181	130.0		MU 11	FU 0359 - 2
SAFS	211 - 33	2.0625	52.39	5.1181	130.0		MU 11	FU 0359 - 3
UCF	211 - 34	2.1250	53.98	5.1181	130.00		MU 12	FU 0360 - 1
UELF	211 - 34	2.1250	53.98	5.1181	130.00		MU 12	FU 0360 - 2
UCF	311 - 34	2.1250	53.98	5.5118	140.00		MU 21	FU 0361 - 1
UCF	X11 - 34	2.1250	53.98	5.6299	143.00		MU 19	FU 0362 - 1
UCFC	211 - 34	2.1250	53.98	5.9055	150.00		MU 13	FU 0363 - 1
UELFC	211 - 34	2.1250	53.98	5.9055	150.00		MU 13	FU 0363 - 2

DIMENSIONS

FLANGED UNITS DIMENSIONS

HYC	Number	ID		SB		Graphic	Figure No.	Group No.
		in	mm	in	mm			
UCFT 211 - 34		2.1250	53.98	7.2441	184.00		MU 14	FU 0364 - 1
UELFT 211 - 34		2.1250	53.98	7.2441	184.00		MU 14	FU 0364 - 2
SAFT 211 - 34		2.1250	53.98	7.2441	184.00		MU 14	FU 0364 - 3
UCFL 211 - 34		2.1250	53.98	7.2441	184.00		MU 15	FU 0365 - 1
UELFL 211 - 34		2.1250	53.98	7.2441	184.00		MU 15	FU 0365 - 2
UCFL 311 - 34		2.1250	53.98	7.7953	198.00		MU 22	FU 0366 - 1
UCFS 211 - 34		2.1250	53.98	5.1181	130.0		MU 11	FU 0367 - 1
UELFS 211 - 34		2.1250	53.98	5.1181	130.0		MU 11	FU 0367 - 2
SAFS 211 - 34		2.1250	53.98	5.1181	130.0		MU 11	FU 0367 - 3
UCF 211		2.1654	55.00	5.1181	130.00		MU 12	FU 0368 - 1
UELF 211		2.1654	55.00	5.1181	130.00		MU 12	FU 0368 - 2
SAF 211		2.1654	55.00	5.1181	130.00		MU 12	FU 0368 - 3
UCF 311		2.1654	55.00	5.5118	140.00		MU 21	FU 0369 - 1
UKF 212		2.1654	55.00	5.6299	143.00		MU 16	FU 0370 - 1
UCF X11		2.1654	55.00	5.6299	143.00		MU 19	FU 0371 - 1
UCFC 211		2.1654	55.00	5.9055	150.00		MU 13	FU 0372 - 1
UELFC 211		2.1654	55.00	5.9055	150.00		MU 13	FU 0372 - 2
SAFC 211		2.1654	55.00	5.9055	150.00		MU 13	FU 0372 - 3
UKFC 212		2.1654	55.00	6.2992	160.00		MU 17	FU 0373 - 1
UCFT 211		2.1654	55.00	7.2441	184.00		MU 14	FU 0374 - 1
UELFT 211		2.1654	55.00	7.2441	184.00		MU 14	FU 0374 - 2
SAFT 211		2.1654	55.00	7.2441	184.00		MU 14	FU 0374 - 3
UCFL 211		2.1654	55.00	7.2441	184.00		MU 15	FU 0375 - 1
UELFL 211		2.1654	55.00	7.2441	184.00		MU 15	FU 0375 - 2
SAFL 211		2.1654	55.00	7.2441	184.00		MU 15	FU 0375 - 3
UCFL 311		2.1654	55.00	7.7953	198.00		MU 22	FU 0376 - 1
UKFL 212		2.1654	55.00	7.9528	202.00		MU 18	FU 0377 - 1
UCFS 211		2.1654	55.00	5.1181	130.0		MU 11	FU 0378 - 1
UELFS 211		2.1654	55.00	5.1181	130.0		MU 11	FU 0378 - 2
SAFS 211		2.1654	55.00	5.1181	130.0		MU 11	FU 0378 - 3
UCF 211 - 35		2.1875	55.56	5.1181	130.00		MU 12	FU 0379 - 1
UELF 211 - 35		2.1875	55.56	5.1181	130.00		MU 12	FU 0379 - 2
SAF 211 - 35		2.1875	55.56	5.1181	130.00		MU 12	FU 0379 - 3
UCF 311 - 35		2.1875	55.56	5.5118	140.00		MU 21	FU 0380 - 1
UCF X11 - 35		2.1875	55.56	5.6299	143.00		MU 19	FU 0381 - 1
UCFC 211 - 35		2.1875	55.56	5.9055	150.00		MU 13	FU 0382 - 1
UELFC 211 - 35		2.1875	55.56	5.9055	150.00		MU 13	FU 0382 - 2
UCFT 211 - 35		2.1875	55.56	7.2441	184.00		MU 14	FU 0383 - 1
UELFT 211 - 35		2.1875	55.56	7.2441	184.00		MU 14	FU 0383 - 2
SAFT 211 - 35		2.1875	55.56	7.2441	184.00		MU 14	FU 0383 - 3
UCFL 211 - 35		2.1875	55.56	7.2441	184.00		MU 15	FU 0384 - 1
UELFL 211 - 35		2.1875	55.56	7.2441	184.00		MU 15	FU 0384 - 2

FLANGED UNITS DIMENSIONS











































HYC	Number	ID		SB		Graphic	Figure No.	Group No.
		in	mm	in	mm			
SAFL	211 - 35	2.1875	55.56	7.2441	184.00		MU 15	FU 0384 - 3
UCFL	311 - 35	2.1875	55.56	7.7953	198.00		MU 22	FU 0385 - 1
UCFS	211 - 35	2.1875	55.56	5.1181	130.0		MU 11	FU 0386 - 1
UELFS	211 - 35	2.1875	55.56	5.1181	130.0		MU 11	FU 0386 - 2
SAFS	211 - 35	2.1875	55.56	5.1181	130.0		MU 11	FU 0386 - 3
UCF	212 - 36	2.2500	57.15	5.6299	143.00		MU 12	FU 0387 - 1
UELF	212 - 36	2.2500	57.15	5.6299	143.00		MU 12	FU 0387 - 2
UCF	X12 - 36	2.2500	57.15	5.8661	149.00		MU 19	FU 0388 - 1
UCF	312 - 36	2.2500	57.15	5.9055	150.00		MU 21	FU 0389 - 1
UCFC	212 - 36	2.2500	57.15	6.2992	160.00		MU 13	FU 0390 - 1
UELFC	212 - 36	2.2500	57.15	6.2992	160.00		MU 13	FU 0390 - 2
UCFT	212 - 36	2.2500	57.15	7.9528	202.00		MU 14	FU 0391 - 1
UELFT	212 - 36	2.2500	57.15	7.9528	202.00		MU 14	FU 0391 - 2
UCFL	212 - 36	2.2500	57.15	7.9528	202.00		MU 15	FU 0392 - 1
UELFL	212 - 36	2.2500	57.15	7.9528	202.00		MU 15	FU 0392 - 2
UCFL	312 - 36	2.2500	57.15	8.3465	212.00		MU 22	FU 0393 - 1
UCFS	212 - 36	2.2500	57.15	5.6299	143.0		MU 11	FU 0394 - 1
UELFS	212 - 36	2.2500	57.15	5.6299	143.0		MU 11	FU 0394 - 2
UCF	212 - 37	2.3125	58.74	5.6299	143.00		MU 12	FU 0395 - 1
UELF	212 - 37	2.3125	58.74	5.6299	143.00		MU 12	FU 0395 - 2
UCF	X12 - 37	2.3125	58.74	5.8661	149.00		MU 19	FU 0396 - 1
UCF	312 - 37	2.3125	58.74	5.9055	150.00		MU 21	FU 0397 - 1
UCFC	212 - 37	2.3125	58.74	6.2992	160.00		MU 13	FU 0398 - 1
UELFC	212 - 37	2.3125	58.74	6.2992	160.00		MU 13	FU 0398 - 2
UCFT	212 - 37	2.3125	58.74	7.9528	202.00		MU 14	FU 0399 - 1
UELFT	212 - 37	2.3125	58.74	7.9528	202.00		MU 14	FU 0399 - 2
UCFL	212 - 37	2.3125	58.74	7.9528	202.00		MU 15	FU 0400 - 1
UELFL	212 - 37	2.3125	58.74	7.9528	202.00		MU 15	FU 0400 - 2
UCFL	312 - 37	2.3125	58.74	8.3465	212.00		MU 22	FU 0401 - 1
UCFS	212 - 37	2.3125	58.74	5.6299	143.0		MU 11	FU 0402 - 1
UELFS	212 - 37	2.3125	58.74	5.6299	143.0		MU 11	FU 0402 - 2
UCF	212	2.3622	60.00	5.6299	143.00		MU 12	FU 0403 - 1
UELF	212	2.3622	60.00	5.6299	143.00		MU 12	FU 0403 - 2
UKF	213	2.3622	60.00	5.8661	149.00		MU 16	FU 0404 - 1
UCF	X12	2.3622	60.00	5.8661	149.00		MU 19	FU 0405 - 1
UCF	312	2.3622	60.00	5.9055	150.00		MU 21	FU 0406 - 1
UCFC	212	2.3622	60.00	6.2992	160.00		MU 13	FU 0407 - 1
UELFC	212	2.3622	60.00	6.2992	160.00		MU 13	FU 0407 - 2
UKFC	213	2.3622	60.00	6.6929	170.00		MU 17	FU 0408 - 1
UCFT	212	2.3622	60.00	7.9528	202.00		MU 14	FU 0409 - 1
UELFT	212	2.3622	60.00	7.9528	202.00		MU 14	FU 0409 - 2
UCFL	212	2.3622	60.00	7.9528	202.00		MU 15	FU 0410 - 1

DIMENSIONS

FLANGED UNITS DIMENSIONS











































HYC	Number	ID		SB		Graphic	Figure No.	Group No.
		in	mm	in	mm			
UELFL	212	2.3622	60.00	7.9528	202.00		MU 15	FU 0410 - 2
UKFL	213	2.3622	60.00	8.2677	210.00		MU 18	FU 0411 - 1
UCFL	312	2.3622	60.00	8.3465	212.00		MU 22	FU 0412 - 1
UCFS	212	2.3622	60.00	5.6299	143.0		MU 11	FU 0413 - 1
UELFS	212	2.3622	60.00	5.6299	143.0		MU 11	FU 0413 - 2
UCF	212 - 38	2.3750	60.33	5.6299	143.00		MU 12	FU 0414 - 1
UELF	212 - 38	2.3750	60.33	5.6299	143.00		MU 12	FU 0414 - 2
UCF	X12 - 38	2.3750	60.33	5.8661	149.00		MU 19	FU 0415 - 1
UCF	312 - 38	2.3750	60.33	5.9055	150.00		MU 21	FU 0416 - 1
UCFC	212 - 38	2.3750	60.33	6.2992	160.00		MU 13	FU 0417 - 1
UELFC	212 - 38	2.3750	60.33	6.2992	160.00		MU 13	FU 0417 - 2
UCFT	212 - 38	2.3750	60.33	7.9528	202.00		MU 14	FU 0418 - 1
UELFT	212 - 38	2.3750	60.33	7.9528	202.00		MU 14	FU 0418 - 2
UCFL	212 - 38	2.3750	60.33	7.9528	202.00		MU 15	FU 0419 - 1
UELFL	212 - 38	2.3750	60.33	7.9528	202.00		MU 15	FU 0419 - 2
UCFL	312 - 38	2.3750	60.33	8.3465	212.00		MU 22	FU 0420 - 1
UCFS	212 - 38	2.3750	60.33	5.6299	143.0		MU 11	FU 0421 - 1
UELFS	212 - 38	2.3750	60.33	5.6299	143.0		MU 11	FU 0421 - 2
UCF	212 - 39	2.4375	61.91	5.6299	143.00		MU 12	FU 0422 - 1
UELF	212 - 39	2.4375	61.91	5.6299	143.00		MU 12	FU 0422 - 2
UCF	X12 - 39	2.4375	61.91	5.8661	149.00		MU 19	FU 0423 - 1
UCF	312 - 39	2.4375	61.91	5.9055	150.00		MU 21	FU 0424 - 1
UCFC	212 - 39	2.4375	61.91	6.2992	160.00		MU 13	FU 0425 - 1
UELFC	212 - 39	2.4375	61.91	6.2992	160.00		MU 13	FU 0425 - 2
UCFT	212 - 39	2.4375	61.91	7.9528	202.00		MU 14	FU 0426 - 1
UELFT	212 - 39	2.4375	61.91	7.9528	202.00		MU 14	FU 0426 - 2
UCFL	212 - 39	2.4375	61.91	7.9528	202.00		MU 15	FU 0427 - 1
UELFL	212 - 39	2.4375	61.91	7.9528	202.00		MU 15	FU 0427 - 2
UCFL	312 - 39	2.4375	61.91	8.3465	212.00		MU 22	FU 0428 - 1
UCFS	212 - 39	2.4375	61.91	5.6299	143.0		MU 11	FU 0429 - 1
UELFS	212 - 39	2.4375	61.91	5.6299	143.0		MU 11	FU 0429 - 2
UCF	213 - 40	2.5000	63.50	5.8661	149.00		MU 12	FU 0430 - 1
UELF	213 - 40	2.5000	63.50	5.8661	149.00		MU 12	FU 0430 - 2
UCF	X13 - 40	2.5000	63.50	5.8661	149.00		MU 19	FU 0431 - 1
UCF	313 - 40	2.5000	63.50	6.5354	166.00		MU 21	FU 0432 - 1
UCFC	213 - 40	2.5000	63.50	6.6929	170.00		MU 13	FU 0433 - 1
UELFC	213 - 40	2.5000	63.50	6.6929	170.00		MU 13	FU 0433 - 2
UCFT	213 - 40	2.5000	63.50	8.2677	210.00		MU 14	FU 0434 - 1
UELFT	213 - 40	2.5000	63.50	8.2677	210.00		MU 14	FU 0434 - 2
UCFL	213 - 40	2.5000	63.50	8.2677	210.00		MU 15	FU 0435 - 1
UELFL	213 - 40	2.5000	63.50	8.2677	210.00		MU 15	FU 0435 - 2
UCFL	313 - 40	2.5000	63.50	9.4488	240.00		MU 22	FU 0436 - 1

FLANGED UNITS DIMENSIONS











































HYC	Number	ID		SB		Graphic	Figure No.	Group No.
		in	mm	in	mm			
UCFS	213 - 40	2.5000	63.50	5.8661	149.0		MU 11	FU 0437 - 1
UELFS	213 - 40	2.5000	63.50	5.8661	149.0		MU 11	FU 0437 - 2
UCF	213	2.5591	65.00	5.8661	149.00		MU 12	FU 0438 - 1
UELF	213	2.5591	65.00	5.8661	149.00		MU 12	FU 0438 - 2
UCF	X13	2.5591	65.00	5.8661	149.00		MU 19	FU 0439 - 1
UCF	313	2.5591	65.00	6.5354	166.00		MU 21	FU 0440 - 1
UCFC	213	2.5591	65.00	6.6929	170.00		MU 13	FU 0441 - 1
UELFC	213	2.5591	65.00	6.6929	170.00		MU 13	FU 0441 - 2
UCFT	213	2.5591	65.00	8.2677	210.00		MU 14	FU 0442 - 1
UELFT	213	2.5591	65.00	8.2677	210.00		MU 14	FU 0442 - 2
UCFL	213	2.5591	65.00	8.2677	210.00		MU 15	FU 0443 - 1
UELFL	213	2.5591	65.00	8.2677	210.00		MU 15	FU 0443 - 2
UCFL	313	2.5591	65.00	9.4488	240.00		MU 22	FU 0444 - 1
UCFS	213	2.5591	65.00	5.8661	149.0		MU 11	FU 0445 - 1
UELFS	213	2.5591	65.00	5.8661	149.0		MU 11	FU 0445 - 2
UCF	213 - 41	2.5625	65.09	5.8661	149.00		MU 12	FU 0446 - 1
UELF	213 - 41	2.5625	65.09	5.8661	149.00		MU 12	FU 0446 - 2
UCF	X13 - 41	2.5625	65.09	5.8661	149.00		MU 19	FU 0447 - 1
UCF	313 - 41	2.5625	65.09	6.5354	166.00		MU 21	FU 0448 - 1
UCFC	213 - 41	2.5625	65.09	6.6929	170.00		MU 13	FU 0449 - 1
UELFC	213 - 41	2.5625	65.09	6.6929	170.00		MU 13	FU 0449 - 2
UCFT	213 - 41	2.5625	65.09	8.2677	210.00		MU 14	FU 0450 - 1
UELFT	213 - 41	2.5625	65.09	8.2677	210.00		MU 14	FU 0450 - 2
UCFL	213 - 41	2.5625	65.09	8.2677	210.00		MU 15	FU 0451 - 1
UELFL	213 - 41	2.5625	65.09	8.2677	210.00		MU 15	FU 0451 - 2
UCFL	313 - 41	2.5625	65.09	9.4488	240.00		MU 22	FU 0452 - 1
UCFS	213 - 41	2.5625	65.09	5.8661	149.0		MU 11	FU 0453 - 1
UELFS	213 - 41	2.5625	65.09	5.8661	149.0		MU 11	FU 0453 - 2
UCF	214 - 42	2.6250	66.68	5.9843	152.00		MU 12	FU 0454 - 1
UELF	214 - 42	2.6250	66.68	5.9843	152.00		MU 12	FU 0454 - 2
UCF	X14 - 42	2.6250	66.68	5.9843	152.00		MU 19	FU 0455 - 1
UCFC	214 - 42	2.6250	66.68	6.9685	177.00		MU 13	FU 0456 - 1
UELFC	214 - 42	2.6250	66.68	6.9685	177.00		MU 13	FU 0456 - 2
UCF	314 - 42	2.6250	66.68	7.0079	178.00		MU 21	FU 0457 - 1
UCFT	214 - 42	2.6250	66.68	8.5039	216.00		MU 14	FU 0458 - 1
UELFT	214 - 42	2.6250	66.68	8.5039	216.00		MU 14	FU 0458 - 2
UCFL	214 - 42	2.6250	66.68	8.5039	216.00		MU 15	FU 0459 - 1
UELFL	214 - 42	2.6250	66.68	8.5039	216.00		MU 15	FU 0459 - 2
UCFL	314 - 42	2.6250	66.68	9.8425	250.00		MU 22	FU 0460 - 1
UCFS	214 - 42	2.6250	66.68	5.9843	152.0		MU 11	FU 0461 - 1
UELFS	214 - 42	2.6250	66.68	5.9843	152.0		MU 11	FU 0461 - 2
UCF	214 - 43	2.6875	68.26	5.9843	152.00		MU 12	FU 0462 - 1

DIMENSIONS

FLANGED UNITS DIMENSIONS











































HYC	Number	ID		SB		Graphic	Figure No.	Group No.
		in	mm	in	mm			
UELF	214 - 43	2.6875	68.26	5.9843	152.00		MU 12	FU 0462 - 2
UCF	X14 - 43	2.6875	68.26	5.9843	152.00		MU 19	FU 0463 - 1
UCFC	214 - 43	2.6875	68.26	6.9685	177.00		MU 13	FU 0464 - 1
UELFC	214 - 43	2.6875	68.26	6.9685	177.00		MU 13	FU 0464 - 2
UCF	314 - 43	2.6875	68.26	7.0079	178.00		MU 21	FU 0465 - 1
UCFT	214 - 43	2.6875	68.26	8.5039	216.00		MU 14	FU 0466 - 1
UELFT	214 - 43	2.6875	68.26	8.5039	216.00		MU 14	FU 0466 - 2
UCFL	214 - 43	2.6875	68.26	8.5039	216.00		MU 15	FU 0467 - 1
UELFL	214 - 43	2.6875	68.26	8.5039	216.00		MU 15	FU 0467 - 2
UCFL	314 - 43	2.6875	68.26	9.8425	250.00		MU 22	FU 0468 - 1
UCFS	214 - 43	2.6875	68.26	5.9843	152.0		MU 11	FU 0469 - 1
UELFS	214 - 43	2.6875	68.26	5.9843	152.0		MU 11	FU 0469 - 2
UCF	214 - 44	2.7500	69.85	5.9843	152.00		MU 12	FU 0470 - 1
UELF	214 - 44	2.7500	69.85	5.9843	152.00		MU 12	FU 0470 - 2
UCF	X14 - 44	2.7500	69.85	5.9843	152.00		MU 19	FU 0471 - 1
UCFC	214 - 44	2.7500	69.85	6.9685	177.00		MU 13	FU 0472 - 1
UELFC	214 - 44	2.7500	69.85	6.9685	177.00		MU 13	FU 0472 - 2
UCF	314 - 44	2.7500	69.85	7.0079	178.00		MU 21	FU 0473 - 1
UCFT	214 - 44	2.7500	69.85	8.5039	216.00		MU 14	FU 0474 - 1
UELFT	214 - 44	2.7500	69.85	8.5039	216.00		MU 14	FU 0474 - 2
UCFL	214 - 44	2.7500	69.85	8.5039	216.00		MU 15	FU 0475 - 1
UELFL	214 - 44	2.7500	69.85	8.5039	216.00		MU 15	FU 0475 - 2
UCFL	314 - 44	2.7500	69.85	9.8425	250.00		MU 22	FU 0476 - 1
UCFS	214 - 44	2.7500	69.85	5.9843	152.0		MU 11	FU 0477 - 1
UELFS	214 - 44	2.7500	69.85	5.9843	152.0		MU 11	FU 0477 - 2
UCF	214	2.7559	70.00	5.9843	152.00		MU 12	FU 0478 - 1
UELF	214	2.7559	70.00	5.9843	152.00		MU 12	FU 0478 - 2
UCF	X14	2.7559	70.00	5.9843	152.00		MU 19	FU 0479 - 1
UCFC	214	2.7559	70.00	6.9685	177.00		MU 13	FU 0480 - 1
UELFC	214	2.7559	70.00	6.9685	177.00		MU 13	FU 0480 - 2
UCF	314	2.7559	70.00	7.0079	178.00		MU 21	FU 0481 - 1
UCFT	214	2.7559	70.00	8.5039	216.00		MU 14	FU 0482 - 1
UELFT	214	2.7559	70.00	8.5039	216.00		MU 14	FU 0482 - 2
UCFL	214	2.7559	70.00	8.5039	216.00		MU 15	FU 0483 - 1
UELFL	214	2.7559	70.00	8.5039	216.00		MU 15	FU 0483 - 2
UCFL	314	2.7559	70.00	9.8425	250.00		MU 22	FU 0484 - 1
UCFS	214	2.7559	70.00	5.9843	152.0		MU 11	FU 0485 - 1
UELFS	214	2.7559	70.00	5.9843	152.0		MU 11	FU 0485 - 2
UCF	X15 - 45	2.8125	71.44	5.9843	152.00		MU 19	FU 0486 - 1
UCF	215 - 45	2.8125	71.44	6.2598	159.00		MU 12	FU 0487 - 1
UELF	215 - 45	2.8125	71.44	6.2598	159.00		MU 12	FU 0487 - 2
UCFC	215 - 45	2.8125	71.44	7.2441	184.00		MU 13	FU 0488 - 1

FLANGED UNITS DIMENSIONS





HYC	Number	ID		SB		Graphic	Figure No.	Group No.
		in	mm	in	mm			
UELFC	215 - 45	2.8125	71.44	7.2441	184.00		MU 13	FU 0488 - 2
UCF	315 - 45	2.8125	71.44	7.2441	184.00		MU 21	FU 0489 - 1
UCFL	215 - 45	2.8125	71.44	8.8583	225.00		MU 15	FU 0490 - 1
UELFL	215 - 45	2.8125	71.44	8.8583	225.00		MU 15	FU 0490 - 2
UCFL	315 - 45	2.8125	71.44	10.2362	260.00		MU 22	FU 0491 - 1
UCFS	215 - 45	2.8125	71.44	6.0000	152.4		MU 11	FU 0492 - 1
UCF	X15 - 46	2.8750	73.03	5.9843	152.00		MU 19	FU 0493 - 1
UCF	215 - 46	2.8750	73.03	6.2598	159.00		MU 12	FU 0494 - 1
UELF	215 - 46	2.8750	73.03	6.2598	159.00		MU 12	FU 0494 - 2
UCFC	215 - 46	2.8750	73.03	7.2441	184.00		MU 13	FU 0495 - 1
UELFC	215 - 46	2.8750	73.03	7.2441	184.00		MU 13	FU 0495 - 2
UCF	315 - 46	2.8750	73.03	7.2441	184.00		MU 21	FU 0496 - 1
UCFL	215 - 46	2.8750	73.03	8.8583	225.00		MU 15	FU 0497 - 1
UELFL	215 - 46	2.8750	73.03	8.8583	225.00		MU 15	FU 0497 - 2
UCFL	315 - 46	2.8750	73.03	10.2362	260.00		MU 22	FU 0498 - 1
UCFS	215 - 46	2.8750	73.03	6.0000	152.4		MU 11	FU 0499 - 1
UELFS	215 - 46	2.8750	73.03	6.0000	152.4		MU 11	FU 0499 - 2
UCF	X15 - 47	2.9375	74.61	5.9843	152.00		MU 19	FU 0500 - 1
UCF	215 - 47	2.9375	74.61	6.2598	159.00		MU 12	FU 0501 - 1
UELF	215 - 47	2.9375	74.61	6.2598	159.00		MU 12	FU 0501 - 2
UCFC	215 - 47	2.9375	74.61	7.2441	184.00		MU 13	FU 0502 - 1
UELFC	215 - 47	2.9375	74.61	7.2441	184.00		MU 13	FU 0502 - 2
UCF	315 - 47	2.9375	74.61	7.2441	184.00		MU 21	FU 0503 - 1
UCFL	215 - 47	2.9375	74.61	8.8583	225.00		MU 15	FU 0504 - 1
UELFL	215 - 47	2.9375	74.61	8.8583	225.00		MU 15	FU 0504 - 2
UCFL	315 - 47	2.9375	74.61	10.2362	260.00		MU 22	FU 0505 - 1
UCFS	215 - 47	2.9375	74.61	6.0000	152.4		MU 11	FU 0506 - 1
UELFS	215 - 47	2.9375	74.61	6.0000	152.4		MU 11	FU 0506 - 2
UCF	X15	2.9528	75.00	5.9843	152.00		MU 19	FU 0507 - 1
UCF	215	2.9528	75.00	6.2598	159.00		MU 12	FU 0508 - 1
UELF	215	2.9528	75.00	6.2598	159.00		MU 12	FU 0508 - 2
UCFC	215	2.9528	75.00	7.2441	184.00		MU 13	FU 0509 - 1
UELFC	215	2.9528	75.00	7.2441	184.00		MU 13	FU 0509 - 2
UCF	315	2.9528	75.00	7.2441	184.00		MU 21	FU 0510 - 1
UCFL	215	2.9528	75.00	8.8583	225.00		MU 15	FU 0511 - 1
UELFL	215	2.9528	75.00	8.8583	225.00		MU 15	FU 0511 - 2
UCFL	315	2.9528	75.00	10.2362	260.00		MU 22	FU 0512 - 1
UCFS	215	2.9528	75.00	6.0000	152.4		MU 11	FU 0513 - 1
UELFS	215	2.9528	75.00	6.0000	152.4		MU 11	FU 0513 - 2
UCF	X15 - 48	3.0000	76.20	5.9843	152.00		MU 19	FU 0514 - 1
UCF	215 - 48	3.0000	76.20	6.2598	159.00		MU 12	FU 0515 - 1
UELF	215 - 48	3.0000	76.20	6.2598	159.00		MU 12	FU 0515 - 2

DIMENSIONS

FLANGED UNITS DIMENSIONS

HYC	Number	ID		SB		Graphic	Figure No.	Group No.
		in	mm	in	mm			
UCFC	215 - 48	3.0000	76.20	7.2441	184.00		MU 13	FU 0516 - 1
UELFC	215 - 48	3.0000	76.20	7.2441	184.00		MU 13	FU 0516 - 2
UCF	315 - 48	3.0000	76.20	7.2441	184.00		MU 21	FU 0517 - 1
UCFL	215 - 48	3.0000	76.20	8.8583	225.00		MU 15	FU 0518 - 1
UELFL	215 - 48	3.0000	76.20	8.8583	225.00		MU 15	FU 0518 - 2
UCFL	315 - 48	3.0000	76.20	10.2362	260.00		MU 22	FU 0519 - 1
UCFS	215 - 48	3.0000	76.20	6.0000	152.4		MU 11	FU 0520 - 1
UCF	216 - 49	3.0625	77.79	6.4961	165.00		MU 12	FU 0521 - 1
UCF	X16 - 49	3.0625	77.79	6.7323	171.00		MU 19	FU 0522 - 1
UCF	316 - 49	3.0625	77.79	7.7165	196.00		MU 21	FU 0523 - 1
UCFC	216 - 49	3.0625	77.79	7.8740	200.00		MU 13	FU 0524 - 1
UCFL	216 - 49	3.0625	77.79	9.1732	233.00		MU 15	FU 0525 - 1
UCFL	316 - 49	3.0625	77.79	11.2205	285.00		MU 22	FU 0526 - 1
UCF	216 - 50	3.1250	79.38	6.4961	165.00		MU 12	FU 0527 - 1
UCF	X16 - 50	3.1250	79.38	6.7323	171.00		MU 19	FU 0528 - 1
UCF	316 - 50	3.1250	79.38	7.7165	196.00		MU 21	FU 0529 - 1
UCFC	216 - 50	3.1250	79.38	7.8740	200.00		MU 13	FU 0530 - 1
UCFL	216 - 50	3.1250	79.38	9.1732	233.00		MU 15	FU 0531 - 1
UCFL	316 - 50	3.1250	79.38	11.2205	285.00		MU 22	FU 0532 - 1
UCF	216	3.1496	80.00	6.4961	165.00		MU 12	FU 0533 - 1
UCF	X16	3.1496	80.00	6.7323	171.00		MU 19	FU 0534 - 1
UCF	316	3.1496	80.00	7.7165	196.00		MU 21	FU 0535 - 1
UCFC	216	3.1496	80.00	7.8740	200.00		MU 13	FU 0536 - 1
UCFL	216	3.1496	80.00	9.1732	233.00		MU 15	FU 0537 - 1
UCFL	316	3.1496	80.00	11.2205	285.00		MU 22	FU 0538 - 1
UCF	216 - 51	3.1875	80.96	6.4961	165.00		MU 12	FU 0539 - 1
UCFC	216 - 51	3.1875	80.96	7.8740	200.00		MU 13	FU 0540 - 1
UCFL	216 - 51	3.1875	80.96	9.1732	233.00		MU 15	FU 0541 - 1
UCF	217 - 52	3.2500	82.55	6.8898	175.00		MU 12	FU 0542 - 1
UCFC	217 - 52	3.2500	82.55	8.1890	208.00		MU 13	FU 0543 - 1
UCFL	217 - 52	3.2500	82.55	9.7638	248.00		MU 15	FU 0544 - 1
UCF	217 - 53	3.3125	84.14	6.8898	175.00		MU 12	FU 0545 - 1
UCFC	217 - 53	3.3125	84.14	8.1890	208.00		MU 13	FU 0546 - 1
UCFL	217 - 53	3.3125	84.14	9.7638	248.00		MU 15	FU 0547 - 1
UCF	217	3.3465	85.00	6.8898	175.00		MU 12	FU 0548 - 1
UCFC	217	3.3465	85.00	8.1890	208.00		MU 13	FU 0549 - 1
UCFL	217	3.3465	85.00	9.7638	248.00		MU 15	FU 0550 - 1
UCF	217 - 55	3.4375	87.31	6.8898	175.00		MU 12	FU 0551 - 1
UCFC	217 - 55	3.4375	87.31	8.1890	208.00		MU 13	FU 0552 - 1
UCFL	217 - 55	3.4375	87.31	9.7638	248.00		MU 15	FU 0553 - 1
UCF	218 - 56	3.5000	88.90	7.3622	187.00		MU 12	FU 0554 - 1
UCFC	218 - 56	3.5000	88.90	8.6614	220.00		MU 13	FU 0555 - 1

FLANGED UNITS DIMENSIONS

HYC	Number	ID		SB		Graphic	Figure No.	Group No.
		in	mm	in	mm			
	UCFL 218 - 56	3.5000	88.90	10.4331	265.00		MU 15	FU 0556 - 1
	UCF 218	3.5433	90.00	7.3622	187.00		MU 12	FU 0557 - 1
	UCFC 218	3.5433	90.00	8.6614	220.00		MU 13	FU 0558 - 1
	UCFL 218	3.5433	90.00	10.4331	265.00		MU 15	FU 0559 - 1











































■ ID = Inside Diameter ■ SB = Shaft Center to Base

TAKE - UP UNITS, CYLINDRICAL CARTRIDGES & HANGER BEARINGS, ETC. DIMENSIONS

<i>HYC</i>	Number	ID in	OD in	W in	SE in	PS	SH in	SW in	Graphic	Figure No.	Group No.
	UCC 201	0.4724	2.8346	1.2205					⊙	MU 23	OT 0001 - 1
	UCC 201 - 8	0.5000	2.8346	1.2205					⊙	MU 23	OT 0002 - 1
	UCC 202 - 9	0.5625	2.8346	1.2205					⊙	MU 23	OT 0003 - 1
	UCC 202	0.5906	2.8346	1.2205					⊙	MU 23	OT 0004 - 1
	UCC 202 - 10	0.6250	2.8346	1.2205					⊙	MU 23	OT 0005 - 1
	UCC 203	0.6693	2.8346	1.2205					⊙	MU 23	OT 0006 - 1
	UCC 203 - 11	0.6875	2.8346	1.2205					⊙	MU 23	OT 0007 - 1
	UCC 204 - 12	0.7500	2.8346	1.2205					⊙	MU 23	OT 0008 - 1
	UCC 204	0.7874	2.8346	1.2205					⊙	MU 23	OT 0009 - 1
	UKC 205	0.7874	3.1496	1.3386					⊙	MU 27	OT 0010 - 1
	UCC 205 - 13	0.8125	3.1496	1.3386					⊙	MU 23	OT 0011 - 1
	UCC 205 - 14	0.8750	3.1496	1.3386					⊙	MU 23	OT 0012 - 1
	UCC 205 - 15	0.9375	3.1496	1.3386					⊙	MU 23	OT 0013 - 1
	UCC 205	0.9843	3.1496	1.3386					⊙	MU 23	OT 0014 - 1
	UKC 206	0.9843	3.3465	1.5000					⊙	MU 27	OT 0015 - 1
	UCC 205 - 16	1.0000	3.1496	1.3386					⊙	MU 23	OT 0016 - 1
	UCC 206 - 17	1.0625	3.3465	1.5000					⊙	MU 23	OT 0017 - 1
	UCC 206 - 18	1.1250	3.3465	1.5000					⊙	MU 23	OT 0018 - 1
	UCC 206	1.1811	3.3465	1.5000					⊙	MU 23	OT 0019 - 1
	UKC 207	1.1811	3.5433	1.6890					⊙	MU 27	OT 0020 - 1
	UCC 206 - 19	1.1875	3.3465	1.5000					⊙	MU 23	OT 0021 - 1
	UCC 206 - 20	1.2500	3.3465	1.5000					⊙	MU 23	OT 0022 - 1
	UCC 207 - 20	1.2500	3.5433	1.6890					⊙	MU 23	OT 0023 - 1
	UCC 207 - 21	1.3125	3.5433	1.6890					⊙	MU 23	OT 0024 - 1
	UCC 207 - 22	1.3750	3.5433	1.6890					⊙	MU 23	OT 0025 - 1
	UCC 207	1.3780	3.5433	1.6890					⊙	MU 23	OT 0026 - 1
	UKC 208	1.3780	3.9370	1.9370					⊙	MU 27	OT 0027 - 1
	UCC 207 - 23	1.4375	3.5433	1.6890					⊙	MU 23	OT 0028 - 1
	UCC 208 - 24	1.5000	3.9370	1.9370					⊙	MU 23	OT 0029 - 1
	UCC 208 - 25	1.5625	3.9370	1.9370					⊙	MU 23	OT 0030 - 1
	UKC 209	1.5748	4.3307	1.9370					⊙	MU 27	OT 0031 - 1
	UCC 208	1.5748	3.9370	1.9370					⊙	MU 23	OT 0032 - 1
	UCC 209 - 26	1.6250	4.3307	1.9370					⊙	MU 23	OT 0033 - 1
	UCC 209 - 27	1.6875	4.3307	1.9370					⊙	MU 23	OT 0034 - 1
	UCC 209 - 28	1.7500	4.3307	1.9370					⊙	MU 23	OT 0035 - 1
	UCC 209	1.7717	4.3307	1.9370					⊙	MU 23	OT 0036 - 1
	UKC 210	1.7717	4.7244	2.0315					⊙	MU 27	OT 0037 - 1
	UCC 210 - 29	1.8125	4.7244	2.0315					⊙	MU 23	OT 0038 - 1
	UCC 210 - 30	1.8750	4.7244	2.0315					⊙	MU 23	OT 0039 - 1
	UCC 210 - 31	1.9375	4.7244	2.0315					⊙	MU 23	OT 0040 - 1
	UCC 210	1.9685	4.7244	2.0315					⊙	MU 23	OT 0041 - 1
	UKC 211	1.9685	4.9213	2.1890					⊙	MU 27	OT 0042 - 1

HYC	Number	ID	OD	W	SE	PS	SH	SW	Graphic	Figure No.	Group No.
		in	in	in	in		in	in			
UCC 210 - 32		2.0000	4.7244	2.0315					⊙	MU 23	OT 0043 - 1
UCC 211 - 32		2.0000	4.9213	2.1890					⊙	MU 23	OT 0044 - 1
UCC 211 - 33		2.0625	4.9213	2.1890					⊙	MU 23	OT 0045 - 1
UCC 211 - 34		2.1250	4.9213	2.1890					⊙	MU 23	OT 0046 - 1
UCC 211		2.1654	4.9213	2.1890					⊙	MU 23	OT 0047 - 1
UKC 212		2.1654	5.1181	2.5630					⊙	MU 27	OT 0048 - 1
UCC 211 - 35		2.1875	4.9213	2.1890					⊙	MU 23	OT 0049 - 1
UCC 212 - 36		2.2500	5.1181	2.5630					⊙	MU 23	OT 0050 - 1
UCC 212 - 37		2.3125	5.1181	2.5630					⊙	MU 23	OT 0051 - 1
UCC 212		2.3622	5.1181	2.5630					⊙	MU 23	OT 0052 - 1
UKC 213		2.3622	5.5118	2.5630					⊙	MU 27	OT 0053 - 1
UCC 212 - 38		2.3750	5.1181	2.5630					⊙	MU 23	OT 0054 - 1
UCC 212 - 39		2.4375	5.1181	2.5630					⊙	MU 23	OT 0055 - 1
UCC 213 - 40		2.5000	5.5118	2.5630					⊙	MU 23	OT 0056 - 1
UCC 213		2.5591	5.5118	2.5630					⊙	MU 23	OT 0057 - 1
UCC 213 - 41		2.5625	5.5118	2.5630					⊙	MU 23	OT 0058 - 1
UCHA 201		0.4724			2.5197	Rp 3/4			⊙	MU 24	OT 0059 - 1
UCHA 201 - 8		0.5000			2.5197	Rp 3/4			⊙	MU 24	OT 0060 - 1
UCHA 202 - 9		0.5625			2.5197	Rp 3/4			⊙	MU 24	OT 0061 - 1
UCHA 202		0.5906			2.5197	Rp 3/4			⊙	MU 24	OT 0062 - 1
UCHA 202 - 10		0.6250			2.5197	Rp 3/4			⊙	MU 24	OT 0063 - 1
UCHA 203		0.6693			2.5197	Rp 3/4			⊙	MU 24	OT 0064 - 1
UCHA 203 - 11		0.6875			2.5197	Rp 3/4			⊙	MU 24	OT 0065 - 1
UCHA 204 - 12		0.7500			2.5197	Rp 3/4			⊙	MU 24	OT 0066 - 1
SAHA 204 - 12		0.7500			2.5197	Rp 3/4			⊙	MU 24	OT 0066 - 2
UCHA 204		0.7874			2.5197	Rp 3/4			⊙	MU 24	OT 0067 - 1
SAHA 204		0.7874			2.5197	Rp 3/4			⊙	MU 24	OT 0067 - 2
UCHA 205 - 13		0.8125			2.5197	Rp 3/4			⊙	MU 24	OT 0068 - 1
UCHA 205 - 14		0.8750			2.5197	Rp 3/4			⊙	MU 24	OT 0069 - 1
SAHA 205 - 14		0.8750			2.5197	Rp 3/4			⊙	MU 24	OT 0069 - 2
UCHA 205 - 15		0.9375			2.5197	Rp 3/4			⊙	MU 24	OT 0070 - 1
UCHA 205		0.9843			2.5197	Rp 3/4			⊙	MU 24	OT 0071 - 1
SAHA 205		0.9843			2.5197	Rp 3/4			⊙	MU 24	OT 0071 - 2
UCHA 205 - 16		1.0000			2.5197	Rp 3/4			⊙	MU 24	OT 0072 - 1
SAHA 205 - 16		1.0000			2.5197	Rp 3/4			⊙	MU 24	OT 0072 - 2
UCHA 206 - 17		1.0625			2.5197	Rp 3/4			⊙	MU 24	OT 0073 - 1
SAHA 206 - 17		1.0625			2.5197	Rp 3/4			⊙	MU 24	OT 0073 - 2
UCHA 206 - 18		1.1250			2.5197	Rp 3/4			⊙	MU 24	OT 0074 - 1
SAHA 206 - 18		1.1250			2.5197	Rp 3/4			⊙	MU 24	OT 0074 - 2
UCHA 206		1.1811			2.5197	Rp 3/4			⊙	MU 24	OT 0075 - 1
SAHA 206		1.1811			2.5197	Rp 3/4			⊙	MU 24	OT 0075 - 2
UCHA 206 - 19		1.1875			2.5197	Rp 3/4			⊙	MU 24	OT 0076 - 1

■ ID = Inside Diameter ■ OD = Outside Diameter ■ W = Width ■ SE = Shaft Center to Elevation ■ PS = Pipe ?
 ■ SH = Shaft Center to High ■ SW = Shaft Center to Width

<i>HYC</i>	Number	ID in	OD in	W in	SE in	PS	SH in	SW in	Graphic	Figure No.	Group No.
SAHA	206 - 19	1.1875			2.5197	Rp 3/4				MU 24	OT 0076 - 2
UCHA	206 - 20	1.2500			2.5197	Rp 3/4				MU 24	OT 0077 - 1
SAHA	206 - 20	1.2500			2.5197	Rp 3/4				MU 24	OT 0077 - 2
UCHA	207 - 20	1.2500			2.7559	Rp 3/4				MU 24	OT 0078 - 1
SAHA	207 - 20	1.2500			2.7559	Rp 3/4				MU 24	OT 0078 - 2
UCHA	207 - 21	1.3125			2.7559	Rp 3/4				MU 24	OT 0079 - 1
UCHA	207 - 22	1.3750			2.7559	Rp 3/4				MU 24	OT 0080 - 1
SAHA	207 - 22	1.3750			2.7559	Rp 3/4				MU 24	OT 0080 - 2
UCHA	207	1.3780			2.7559	Rp 3/4				MU 24	OT 0081 - 1
SAHA	207	1.3780			2.7559	Rp 3/4				MU 24	OT 0081 - 2
UCHA	207 - 23	1.4375			2.7559	Rp 3/4				MU 24	OT 0082 - 1
SAHA	207 - 23	1.4375			2.7559	Rp 3/4				MU 24	OT 0082 - 2
UCHA	208 - 24	1.5000			2.8740	Rp 3/4				MU 24	OT 0083 - 1
SAHA	208 - 24	1.5000			2.8740	Rp 3/4				MU 24	OT 0083 - 2
UCHA	208 - 25	1.5625			2.8740	Rp 3/4				MU 24	OT 0084 - 1
UCHA	208	1.5748			2.8740	Rp 3/4				MU 24	OT 0085 - 1
SAHA	208	1.5748			2.8740	Rp 3/4				MU 24	OT 0085 - 2
UCHA	209 - 26	1.6250			3.2283	Rp 1				MU 24	OT 0086 - 1
UCHA	209 - 27	1.6875			3.2283	Rp 1				MU 24	OT 0087 - 1
UCHA	209 - 28	1.7500			3.2283	Rp 1				MU 24	OT 0088 - 1
SAHA	209 - 28	1.7500			3.2283	Rp 1				MU 24	OT 0088 - 2
UCHA	209	1.7717			3.2283	Rp 1				MU 24	OT 0089 - 1
SAHA	209	1.7717			3.2283	Rp 1				MU 24	OT 0089 - 2
UCHA	210 - 29	1.8125			3.2677	Rp 1				MU 24	OT 0090 - 1
UCHA	210 - 30	1.8750			3.2677	Rp 1				MU 24	OT 0091 - 1
UCHA	210 - 31	1.9375			3.2677	Rp 1				MU 24	OT 0092 - 1
SAHA	210 - 31	1.9375			3.2677	Rp 1				MU 24	OT 0092 - 2
UCHA	210	1.9685			3.2677	Rp 1				MU 24	OT 0093 - 1
SAHA	210	1.9685			3.2677	Rp 1				MU 24	OT 0093 - 2
UCHA	210 - 32	2.0000			3.2677	Rp 1				MU 24	OT 0094 - 1
UCHA	211 - 32	2.0000			3.4252	Rp 5/4				MU 24	OT 0095 - 1
UCHA	211 - 33	2.0625			3.4252	Rp 5/4				MU 24	OT 0096 - 1
UCHA	211 - 34	2.1250			3.4252	Rp 5/4				MU 24	OT 0097 - 1
UCHA	211	2.1654			3.4252	Rp 5/4				MU 24	OT 0098 - 1
UCHA	211 - 35	2.1875			3.4252	Rp 5/4				MU 24	OT 0099 - 1
UCHA	212 - 36	2.2500			4.0157	Rp 5/4				MU 24	OT 0100 - 1
UCHA	212 - 37	2.3125			4.0157	Rp 5/4				MU 24	OT 0101 - 1
UCHA	212	2.3622			4.0157	Rp 5/4				MU 24	OT 0102 - 1
UCHA	212 - 38	2.3750			4.0157	Rp 5/4				MU 24	OT 0103 - 1
UCHA	212 - 39	2.4375			4.0157	Rp 5/4				MU 24	OT 0104 - 1
UCHA	213 - 40	2.5000			4.6063	Rp 3/2				MU 24	OT 0105 - 1
UCHA	213	2.5591			4.6063	Rp 3/2				MU 24	OT 0106 - 1

HYC	Number	ID in	OD in	W in	SE in	PS	SH in	SW in	Graphic	Figure No.	Group No.
UCHA	213 - 41	2.5625			4.6063	Rp 3/2				MU 24	OT 0107 - 1
UCHA	214 - 42	2.6250			4.6063	Rp 3/2				MU 24	OT 0108 - 1
UCHA	214 - 43	2.6875			4.6063	Rp 3/2				MU 24	OT 0109 - 1
UCHA	214 - 44	2.7500			4.6063	Rp 3/2				MU 24	OT 0110 - 1
UCHA	214	2.7559			4.6063	Rp 3/2				MU 24	OT 0111 - 1
UCHA	215 - 45	2.8125			4.6063	Rp 3/2				MU 24	OT 0112 - 1
UCHA	215 - 46	2.8750			4.6063	Rp 3/2				MU 24	OT 0113 - 1
UCHA	215 - 47	2.9375			4.6063	Rp 3/2				MU 24	OT 0114 - 1
UCHA	215	2.9528			4.6063	Rp 3/2				MU 24	OT 0115 - 1
UCHA	215 - 48	3.0000			4.6063	Rp 3/2				MU 24	OT 0116 - 1
UCT	201	0.4724					2.9921	0.4724		MU 26	OT 0117 - 1
UCT	201 - 8	0.5000					2.9921	0.4724		MU 26	OT 0118 - 1
UCT	202 - 9	0.5625					2.9921	0.4724		MU 26	OT 0119 - 1
UCT	202	0.5906					2.9921	0.4724		MU 26	OT 0120 - 1
UCT	202 - 10	0.6250					2.9921	0.4724		MU 26	OT 0121 - 1
UCT	203	0.6693					2.9921	0.4724		MU 26	OT 0122 - 1
UCT	203 - 11	0.6875					2.9921	0.4724		MU 26	OT 0123 - 1
UCT	204 - 12	0.7500					2.9921	0.4724		MU 26	OT 0124 - 1
UELT	204 - 12	0.7500					2.9921	0.4724		MU 26	OT 0124 - 2
SAT	204 - 12	0.7500					2.9921	0.4724		MU 26	OT 0124 - 3
UCST	204 - 12	0.7500					2.9921	0.5315		MU 25	OT 0125 - 1
UELST	204 - 12	0.7500					2.9921	0.5315		MU 25	OT 0125 - 2
SAST	204 - 12	0.7500					2.9921	0.5315		MU 25	OT 0125 - 3
UCT	204	0.7874					2.9921	0.4724		MU 26	OT 0126 - 1
UELT	204	0.7874					2.9921	0.4724		MU 26	OT 0126 - 2
SAT	204	0.7874					2.9921	0.4724		MU 26	OT 0126 - 3
UKT	205	0.7874					2.9921	0.4724		MU 28	OT 0127 - 1
UCST	204	0.7874					2.9921	0.5315		MU 25	OT 0128 - 1
UELST	204	0.7874					2.9921	0.5315		MU 25	OT 0128 - 2
SAST	204	0.7874					2.9921	0.5315		MU 25	OT 0128 - 3
UCT	205 - 13	0.8125					2.9921	0.4724		MU 26	OT 0129 - 1
UELT	205 - 13	0.8125					2.9921	0.4724		MU 26	OT 0129 - 2
SAT	205 - 13	0.8125					2.9921	0.4724		MU 26	OT 0129 - 3
UCST	205 - 13	0.8125					2.9921	0.5315		MU 25	OT 0130 - 1
UELST	205 - 13	0.8125					2.9921	0.5315		MU 25	OT 0130 - 2
SAST	205 - 13	0.8125					2.9921	0.5315		MU 25	OT 0130 - 3
UCT	205 - 14	0.8750					2.9921	0.4724		MU 26	OT 0131 - 1
UELT	205 - 14	0.8750					2.9921	0.4724		MU 26	OT 0131 - 2
SAT	205 - 14	0.8750					2.9921	0.4724		MU 26	OT 0131 - 3
UCST	205 - 14	0.8750					2.9921	0.5315		MU 25	OT 0132 - 1
UELST	205 - 14	0.8750					2.9921	0.5315		MU 25	OT 0132 - 2
SAST	205 - 14	0.8750					2.9921	0.5315		MU 25	OT 0132 - 3

■ ID = Inside Diameter ■ OD = Outside Diameter ■ W = Width ■ SE = Shaft Center to Elevation ■ PS = Pipe ?
 ■ SH = Shaft Center to High ■ SW = Shaft Center to Width











































TAKE - UP UNITS, CYLINDRICAL CARTRIDGES & HANGER BEARINGS, ETC. DIMENSIONS

<i>HYC</i>	Number	ID in	OD in	W in	SE in	PS	SH in	SW in	Graphic	Figure No.	Group No.
	UCT 205 - 15	0.9375					2.9921	0.4724		MU 26	OT 0133 - 1
	UELT 205 - 15	0.9375					2.9921	0.4724		MU 26	OT 0133 - 2
	SAT 205 - 15	0.9375					2.9921	0.4724		MU 26	OT 0133 - 3
	UCST 205 - 15	0.9375					2.9921	0.5315		MU 25	OT 0134 - 1
	UELST 205 - 15	0.9375					2.9921	0.5315		MU 25	OT 0134 - 2
	SAST 205 - 15	0.9375					2.9921	0.5315		MU 25	OT 0134 - 3
	UCT 205	0.9843					2.9921	0.4724		MU 26	OT 0135 - 1
	UELT 205	0.9843					2.9921	0.4724		MU 26	OT 0135 - 2
	SAT 205	0.9843					2.9921	0.4724		MU 26	OT 0135 - 3
	UCST 205	0.9843					2.9921	0.5315		MU 25	OT 0136 - 1
	UELST 205	0.9843					2.9921	0.5315		MU 25	OT 0136 - 2
	SAST 205	0.9843					2.9921	0.5315		MU 25	OT 0136 - 3
	UKT 206	0.9843					3.5039	0.4724		MU 28	OT 0137 - 1
	UCT 205 - 16	1.0000					2.9921	0.4724		MU 26	OT 0138 - 1
	UELT 205 - 16	1.0000					2.9921	0.4724		MU 26	OT 0138 - 2
	SAT 205 - 16	1.0000					2.9921	0.4724		MU 26	OT 0138 - 3
	UCST 205 - 16	1.0000					2.9921	0.5315		MU 25	OT 0139 - 1
	UELST 205 - 16	1.0000					2.9921	0.5315		MU 25	OT 0139 - 2
	SAST 205 - 16	1.0000					2.9921	0.5315		MU 25	OT 0139 - 3
	UCT 206 - 17	1.0625					3.5039	0.4724		MU 26	OT 0140 - 1
	UELT 206 - 17	1.0625					3.5039	0.4724		MU 26	OT 0140 - 2
	SAT 206 - 17	1.0625					3.5039	0.4724		MU 26	OT 0140 - 3
	UCST 206 - 17	1.0625					3.5039	0.5315		MU 25	OT 0141 - 1
	UELST 206 - 17	1.0625					3.5039	0.5315		MU 25	OT 0141 - 2
	SAST 206 - 17	1.0625					3.5039	0.5315		MU 25	OT 0141 - 3
	UCT 206 - 18	1.1250					3.5039	0.4724		MU 26	OT 0142 - 1
	UELT 206 - 18	1.1250					3.5039	0.4724		MU 26	OT 0142 - 2
	SAT 206 - 18	1.1250					3.5039	0.4724		MU 26	OT 0142 - 3
	UCST 206 - 18	1.1250					3.5039	0.5315		MU 25	OT 0143 - 1
	UELST 206 - 18	1.1250					3.5039	0.5315		MU 25	OT 0143 - 2
	SAST 206 - 18	1.1250					3.5039	0.5315		MU 25	OT 0143 - 3
	UCT 206	1.1811					3.5039	0.4724		MU 26	OT 0144 - 1
	UELT 206	1.1811					3.5039	0.4724		MU 26	OT 0144 - 2
	SAT 206	1.1811					3.5039	0.4724		MU 26	OT 0144 - 3
	UKT 207	1.1811					3.5039	0.4724		MU 28	OT 0145 - 1
	UCST 206	1.1811					3.5039	0.5315		MU 25	OT 0146 - 1
	UELST 206	1.1811					3.5039	0.5315		MU 25	OT 0146 - 2
	SAST 206	1.1811					3.5039	0.5315		MU 25	OT 0146 - 3
	UCT 206 - 19	1.1875					3.5039	0.4724		MU 26	OT 0147 - 1
	UELT 206 - 19	1.1875					3.5039	0.4724		MU 26	OT 0147 - 2
	SAT 206 - 19	1.1875					3.5039	0.4724		MU 26	OT 0147 - 3
	UCST 206 - 19	1.1875					3.5039	0.5315		MU 25	OT 0148 - 1

HYC	Number	ID in	OD in	W in	SE in	PS	SH in	SW in	Graphic	Figure No.	Group No.
UELST	206 - 19	1.1875					3.5039	0.5315		MU 25	OT 0148 - 2
SAST	206 - 19	1.1875					3.5039	0.5315		MU 25	OT 0148 - 3
UCT	206 - 20	1.2500					3.5039	0.4724		MU 26	OT 0149 - 1
UELT	206 - 20	1.2500					3.5039	0.4724		MU 26	OT 0149 - 2
SAT	206 - 20	1.2500					3.5039	0.4724		MU 26	OT 0149 - 3
UCT	207 - 20	1.2500					3.5039	0.4724		MU 26	OT 0150 - 1
UELT	207 - 20	1.2500					3.5039	0.4724		MU 26	OT 0150 - 2
SAT	207 - 20	1.2500					3.5039	0.4724		MU 26	OT 0150 - 3
UCST	206 - 20	1.2500					3.5039	0.5315		MU 25	OT 0151 - 1
UELST	206 - 20	1.2500					3.5039	0.5315		MU 25	OT 0151 - 2
SAST	206 - 20	1.2500					3.5039	0.5315		MU 25	OT 0151 - 3
UCST	207 - 20	1.2500					3.5039	0.5315		MU 25	OT 0152 - 1
UELST	207 - 20	1.2500					3.5039	0.5315		MU 25	OT 0152 - 2
SAST	207 - 20	1.2500					3.5039	0.5315		MU 25	OT 0152 - 3
UCT	207 - 21	1.3125					3.5039	0.4724		MU 26	OT 0153 - 1
UELT	207 - 21	1.3125					3.5039	0.4724		MU 26	OT 0153 - 2
SAT	207 - 21	1.3125					3.5039	0.4724		MU 26	OT 0153 - 3
UCST	207 - 21	1.3125					3.5039	0.5315		MU 25	OT 0154 - 1
UELST	207 - 21	1.3125					3.5039	0.5315		MU 25	OT 0154 - 2
SAST	207 - 21	1.3125					3.5039	0.5315		MU 25	OT 0154 - 3
UCT	207 - 22	1.3750					3.5039	0.4724		MU 26	OT 0155 - 1
UELT	207 - 22	1.3750					3.5039	0.4724		MU 26	OT 0155 - 2
SAT	207 - 22	1.3750					3.5039	0.4724		MU 26	OT 0155 - 3
UCST	207 - 22	1.3750					3.5039	0.5315		MU 25	OT 0156 - 1
UELST	207 - 22	1.3750					3.5039	0.5315		MU 25	OT 0156 - 2
SAST	207 - 22	1.3750					3.5039	0.5315		MU 25	OT 0156 - 3
UCT	207	1.3780					3.5039	0.4724		MU 26	OT 0157 - 1
UELT	207	1.3780					3.5039	0.4724		MU 26	OT 0157 - 2
SAT	207	1.3780					3.5039	0.4724		MU 26	OT 0157 - 3
UCST	207	1.3780					3.5039	0.5315		MU 25	OT 0158 - 1
UELST	207	1.3780					3.5039	0.5315		MU 25	OT 0158 - 2
SAST	207	1.3780					3.5039	0.5315		MU 25	OT 0158 - 3
UKT	208	1.3780					4.0157	0.6299		MU 28	OT 0159 - 1
UCT	207 - 23	1.4375					3.5039	0.4724		MU 26	OT 0160 - 1
UELT	207 - 23	1.4375					3.5039	0.4724		MU 26	OT 0160 - 2
SAT	207 - 23	1.4375					3.5039	0.4724		MU 26	OT 0160 - 3
UCST	207 - 23	1.4375					3.5039	0.5315		MU 25	OT 0161 - 1
UELST	207 - 23	1.4375					3.5039	0.5315		MU 25	OT 0161 - 2
SAST	207 - 23	1.4375					3.5039	0.5315		MU 25	OT 0161 - 3
UCST	208 - 24	1.5000					3.9764	0.6890		MU 25	OT 0162 - 1
UELST	208 - 24	1.5000					3.9764	0.6890		MU 25	OT 0162 - 2
SAST	208 - 24	1.5000					3.9764	0.6890		MU 25	OT 0162 - 3

■ ID = Inside Diameter ■ OD = Outside Diameter ■ W = Width ■ SE = Shaft Center to Elevation ■ PS = Pipe ?
 ■ SH = Shaft Center to High ■ SW = Shaft Center to Width

TAKE - UP UNITS, CYLINDRICAL CARTRIDGES & HANGER BEARINGS, ETC. DIMENSIONS

<i>HYC</i>	Number	ID in	OD in	W in	SE in	PS	SH in	SW in	Graphic	Figure No.	Group No.
	UCT 208 - 24	1.5000					4.0157	0.6299		MU 26	OT 0163 - 1
	UELT 208 - 24	1.5000					4.0157	0.6299		MU 26	OT 0163 - 2
	SAT 208 - 24	1.5000					4.0157	0.6299		MU 26	OT 0163 - 3
	UCST 208 - 25	1.5625					3.9764	0.6890		MU 25	OT 0164 - 1
	UELST 208 - 25	1.5625					3.9764	0.6890		MU 25	OT 0164 - 2
	SAST 208 - 25	1.5625					3.9764	0.6890		MU 25	OT 0164 - 3
	UCT 208 - 25	1.5625					4.0157	0.6299		MU 26	OT 0165 - 1
	UELT 208 - 25	1.5625					4.0157	0.6299		MU 26	OT 0165 - 2
	SAT 208 - 25	1.5625					4.0157	0.6299		MU 26	OT 0165 - 3
	UCST 208	1.5748					3.9764	0.6890		MU 25	OT 0166 - 1
	UELST 208	1.5748					3.9764	0.6890		MU 25	OT 0166 - 2
	SAST 208	1.5748					3.9764	0.6890		MU 25	OT 0166 - 3
	UCT 208	1.5748					4.0157	0.6299		MU 26	OT 0167 - 1
	UELT 208	1.5748					4.0157	0.6299		MU 26	OT 0167 - 2
	SAT 208	1.5748					4.0157	0.6299		MU 26	OT 0167 - 3
	UKT 209	1.5748					4.0157	0.6299		MU 28	OT 0168 - 1
	UCST 209 - 26	1.6250					3.9764	0.6890		MU 25	OT 0169 - 1
	UELST 209 - 26	1.6250					3.9764	0.6890		MU 25	OT 0169 - 2
	SAST 209 - 26	1.6250					3.9764	0.6890		MU 25	OT 0169 - 3
	UCT 209 - 26	1.6250					4.0157	0.6299		MU 26	OT 0170 - 1
	UELT 209 - 26	1.6250					4.0157	0.6299		MU 26	OT 0170 - 2
	SAT 209 - 26	1.6250					4.0157	0.6299		MU 26	OT 0170 - 3
	UCST 209 - 27	1.6875					3.9764	0.6890		MU 25	OT 0171 - 1
	UELST 209 - 27	1.6875					3.9764	0.6890		MU 25	OT 0171 - 2
	SAST 209 - 27	1.6875					3.9764	0.6890		MU 25	OT 0171 - 3
	UCT 209 - 27	1.6875					4.0157	0.6299		MU 26	OT 0172 - 1
	UELT 209 - 27	1.6875					4.0157	0.6299		MU 26	OT 0172 - 2
	SAT 209 - 27	1.6875					4.0157	0.6299		MU 26	OT 0172 - 3
	UCST 209 - 28	1.7500					3.9764	0.6890		MU 25	OT 0173 - 1
	UELST 209 - 28	1.7500					3.9764	0.6890		MU 25	OT 0173 - 2
	SAST 209 - 28	1.7500					3.9764	0.6890		MU 25	OT 0173 - 3
	UCT 209 - 28	1.7500					4.0157	0.6299		MU 26	OT 0174 - 1
	UELT 209 - 28	1.7500					4.0157	0.6299		MU 26	OT 0174 - 2
	SAT 209 - 28	1.7500					4.0157	0.6299		MU 26	OT 0174 - 3
	UCST 209	1.7717					3.9764	0.6890		MU 25	OT 0175 - 1
	UELST 209	1.7717					3.9764	0.6890		MU 25	OT 0175 - 2
	SAST 209	1.7717					3.9764	0.6890		MU 25	OT 0175 - 3
	UCT 209	1.7717					4.0157	0.6299		MU 26	OT 0176 - 1
	UELT 209	1.7717					4.0157	0.6299		MU 26	OT 0176 - 2
	SAT 209	1.7717					4.0157	0.6299		MU 26	OT 0176 - 3
	UKT 210	1.7717					4.0157	0.6299		MU 28	OT 0177 - 1
	UCST 210 - 29	1.8125					3.9764	0.6890		MU 25	OT 0178 - 1

■ ID = Inside Diameter ■ OD = Outside Diameter ■ W = Width ■ SE = Shaft Center to Elevation ■ PS = Pipe ?
 ■ SH = Shaft Center to High ■ SW = Shaft Center to Width

TAKE - UP UNITS, CYLINDRICAL CARTRIDGES & HANGER BEARINGS, ETC. DIMENSIONS

<i>HYC</i>	Number	ID in	OD in	W in	SE in	PS	SH in	SW in	Graphic	Figure No.	Group No.
UELST	210 - 29	1.8125					3.9764	0.6890		MU 25	OT 0178 - 2
SAST	210 - 29	1.8125					3.9764	0.6890		MU 25	OT 0178 - 3
UCT	210 - 29	1.8125					4.0157	0.6299		MU 26	OT 0179 - 1
UELT	210 - 29	1.8125					4.0157	0.6299		MU 26	OT 0179 - 2
UCST	210 - 30	1.8750					3.9764	0.6890		MU 25	OT 0180 - 1
UELST	210 - 30	1.8750					3.9764	0.6890		MU 25	OT 0180 - 2
SAST	210 - 30	1.8750					3.9764	0.6890		MU 25	OT 0180 - 3
UCT	210 - 30	1.8750					4.0157	0.6299		MU 26	OT 0181 - 1
UELT	210 - 30	1.8750					4.0157	0.6299		MU 26	OT 0181 - 2
SAT	210 - 30	1.8750					4.0157	0.6299		MU 26	OT 0181 - 3
UCST	210 - 31	1.9375					3.9764	0.6890		MU 25	OT 0182 - 1
UELST	210 - 31	1.9375					3.9764	0.6890		MU 25	OT 0182 - 2
SAST	210 - 31	1.9375					3.9764	0.6890		MU 25	OT 0182 - 3
UCT	210 - 31	1.9375					4.0157	0.6299		MU 26	OT 0183 - 1
UELT	210 - 31	1.9375					4.0157	0.6299		MU 26	OT 0183 - 2
SAT	210 - 31	1.9375					4.0157	0.6299		MU 26	OT 0183 - 3
UCST	210	1.9685					3.9764	0.6890		MU 25	OT 0184 - 1
UELST	210	1.9685					3.9764	0.6890		MU 25	OT 0184 - 2
SAST	210	1.9685					3.9764	0.6890		MU 25	OT 0184 - 3
UCT	210	1.9685					4.0157	0.6299		MU 26	OT 0185 - 1
UELT	210	1.9685					4.0157	0.6299		MU 26	OT 0185 - 2
SAT	210	1.9685					4.0157	0.6299		MU 26	OT 0185 - 3
UKT	211	1.9685					5.1181	0.8661		MU 28	OT 0186 - 1
UCST	210 - 32	2.0000					3.9764	0.6890		MU 25	OT 0187 - 1
UCT	210 - 32	2.0000					4.0157	0.6299		MU 26	OT 0188 - 1
UELT	210 - 32	2.0000					4.0157	0.6299		MU 26	OT 0188 - 2
UCT	211 - 32	2.0000					5.1181	0.8661		MU 26	OT 0189 - 1
UELT	211 - 32	2.0000					5.1181	0.8661		MU 26	OT 0189 - 2
SAT	211 - 32	2.0000					5.1181	0.8661		MU 26	OT 0189 - 3
UCST	211 - 32	2.0000					5.1181	1.0630		MU 25	OT 0190 - 1
UELST	211 - 32	2.0000					5.1181	1.0630		MU 25	OT 0190 - 2
SAST	211 - 32	2.0000					5.1181	1.0630		MU 25	OT 0190 - 3
UCT	211 - 33	2.0625					5.1181	0.8661		MU 26	OT 0191 - 1
UELT	211 - 33	2.0625					5.1181	0.8661		MU 26	OT 0191 - 2
UCST	211 - 33	2.0625					5.1181	1.0630		MU 25	OT 0192 - 1
UELST	211 - 33	2.0625					5.1181	1.0630		MU 25	OT 0192 - 2
SAST	211 - 33	2.0625					5.1181	1.0630		MU 25	OT 0192 - 3
UCT	211 - 34	2.1250					5.1181	0.8661		MU 26	OT 0193 - 1
UELT	211 - 34	2.1250					5.1181	0.8661		MU 26	OT 0193 - 2
UCST	211 - 34	2.1250					5.1181	1.0630		MU 25	OT 0194 - 1
UELST	211 - 34	2.1250					5.1181	1.0630		MU 25	OT 0194 - 2
SAST	211 - 34	2.1250					5.1181	1.0630		MU 25	OT 0194 - 3

DIMENSIONS











































■ ID = Inside Diameter ■ OD = Outside Diameter ■ W = Width ■ SE = Shaft Center to Elevation ■ PS = Pipe ?
 ■ SH = Shaft Center to High ■ SW = Shaft Center to Width

TAKE - UP UNITS, CYLINDRICAL CARTRIDGES & HANGER BEARINGS, ETC. DIMENSIONS

<i>HYC</i>	Number	ID in	OD in	W in	SE in	PS	SH in	SW in	Graphic	Figure No.	Group No.
UCT 211		2.1654					5.1181	0.8661		MU 26	OT 0195 - 1
UELT 211		2.1654					5.1181	0.8661		MU 26	OT 0195 - 2
SAT 211		2.1654					5.1181	0.8661		MU 26	OT 0195 - 3
UKT 212		2.1654					5.1181	0.8661		MU 28	OT 0196 - 1
UCST 211		2.1654					5.1181	1.0630		MU 25	OT 0197 - 1
UELST 211		2.1654					5.1181	1.0630		MU 25	OT 0197 - 2
SAST 211		2.1654					5.1181	1.0630		MU 25	OT 0197 - 3
UCT 211 - 35		2.1875					5.1181	0.8661		MU 26	OT 0198 - 1
UELT 211 - 35		2.1875					5.1181	0.8661		MU 26	OT 0198 - 2
SAT 211 - 35		2.1875					5.1181	0.8661		MU 26	OT 0198 - 3
UCST 211 - 35		2.1875					5.1181	1.0630		MU 25	OT 0199 - 1
UELST 211 - 35		2.1875					5.1181	1.0630		MU 25	OT 0199 - 2
SAST 211 - 35		2.1875					5.1181	1.0630		MU 25	OT 0199 - 3
UCT 212 - 36		2.2500					5.1181	0.8661		MU 26	OT 0200 - 1
UELT 212 - 36		2.2500					5.1181	0.8661		MU 26	OT 0200 - 2
UCST 212 - 36		2.2500					5.1181	1.0630		MU 25	OT 0201 - 1
UELST 212 - 36		2.2500					5.1181	1.0630		MU 25	OT 0201 - 2
UCT 212 - 37		2.3125					5.1181	0.8661		MU 26	OT 0202 - 1
UELT 212 - 37		2.3125					5.1181	0.8661		MU 26	OT 0202 - 2
UCST 212 - 37		2.3125					5.1181	1.0630		MU 25	OT 0203 - 1
UELST 212 - 37		2.3125					5.1181	1.0630		MU 25	OT 0203 - 2
UCT 212		2.3622					5.1181	0.8661		MU 26	OT 0204 - 1
UELT 212		2.3622					5.1181	0.8661		MU 26	OT 0204 - 2
UCST 212		2.3622					5.1181	1.0630		MU 25	OT 0205 - 1
UELST 212		2.3622					5.1181	1.0630		MU 25	OT 0205 - 2
UKT 213		2.3622					5.9449	1.0236		MU 28	OT 0206 - 1
UCT 212 - 38		2.3750					5.1181	0.8661		MU 26	OT 0207 - 1
UELT 212 - 38		2.3750					5.1181	0.8661		MU 26	OT 0207 - 2
UCST 212 - 38		2.3750					5.1181	1.0630		MU 25	OT 0208 - 1
UELST 212 - 38		2.3750					5.1181	1.0630		MU 25	OT 0208 - 2
UCT 212 - 39		2.4375					5.1181	0.8661		MU 26	OT 0209 - 1
UELT 212 - 39		2.4375					5.1181	0.8661		MU 26	OT 0209 - 2
UCST 212 - 39		2.4375					5.1181	1.0630		MU 25	OT 0210 - 1
UELST 212 - 39		2.4375					5.1181	1.0630		MU 25	OT 0210 - 2
UCT 213 - 40		2.5000					5.9449	1.0236		MU 26	OT 0211 - 1
UELT 213 - 40		2.5000					5.9449	1.0236		MU 26	OT 0211 - 2
UCST 213 - 40		2.5000					5.9449	1.0630		MU 25	OT 0212 - 1
UELST 213 - 40		2.5000					5.9449	1.0630		MU 25	OT 0212 - 2
UCT 213		2.5591					5.9449	1.0236		MU 26	OT 0213 - 1
UELT 213		2.5591					5.9449	1.0236		MU 26	OT 0213 - 2
UCST 213		2.5591					5.9449	1.0630		MU 25	OT 0214 - 1
UELST 213		2.5591					5.9449	1.0630		MU 25	OT 0214 - 2











































HYC	Number	ID in	OD in	W in	SE in	PS	SH in	SW in	Graphic	Figure No.	Group No.
UCT	213 - 41	2.5625					5.9449	1.0236		MU 26	OT 0215 - 1
UELT	213 - 41	2.5625					5.9449	1.0236		MU 26	OT 0215 - 2
UCST	213 - 41	2.5625					5.9449	1.0630		MU 25	OT 0216 - 1
UCT	214 - 42	2.6250					5.9449	1.0236		MU 26	OT 0217 - 1
UELT	214 - 42	2.6250					5.9449	1.0236		MU 26	OT 0217 - 2
UCST	214 - 42	2.6250					5.9449	1.0630		MU 25	OT 0218 - 1
UCT	214 - 43	2.6875					5.9449	1.0236		MU 26	OT 0219 - 1
UELT	214 - 43	2.6875					5.9449	1.0236		MU 26	OT 0219 - 2
UCST	214 - 43	2.6875					5.9449	1.0630		MU 25	OT 0220 - 1
UELST	214 - 43	2.6875					5.9449	1.0630		MU 25	OT 0220 - 2
UCT	214 - 44	2.7500					5.9449	1.0236		MU 26	OT 0221 - 1
UELT	214 - 44	2.7500					5.9449	1.0236		MU 26	OT 0221 - 2
UCST	214 - 44	2.7500					5.9449	1.0630		MU 25	OT 0222 - 1
UELST	214 - 44	2.7500					5.9449	1.0630		MU 25	OT 0222 - 2
UCT	214	2.7559					5.9449	1.0236		MU 26	OT 0223 - 1
UELT	214	2.7559					5.9449	1.0236		MU 26	OT 0223 - 2
UCST	214	2.7559					5.9449	1.0630		MU 25	OT 0224 - 1
UELST	214	2.7559					5.9449	1.0630		MU 25	OT 0224 - 2
UCT	215 - 45	2.8125					5.9449	1.0236		MU 26	OT 0225 - 1
UELT	215 - 45	2.8125					5.9449	1.0236		MU 26	OT 0225 - 2
UCST	215 - 45	2.8125					5.9449	1.0630		MU 25	OT 0226 - 1
UCT	215 - 46	2.8750					5.9449	1.0236		MU 26	OT 0227 - 1
UELT	215 - 46	2.8750					5.9449	1.0236		MU 26	OT 0227 - 2
UCST	215 - 46	2.8750					5.9449	1.0630		MU 25	OT 0228 - 1
UELST	215 - 46	2.8750					5.9449	1.0630		MU 25	OT 0228 - 2
UCT	215 - 47	2.9375					5.9449	1.0236		MU 26	OT 0229 - 1
UELT	215 - 47	2.9375					5.9449	1.0236		MU 26	OT 0229 - 2
UCST	215 - 47	2.9375					5.9449	1.0630		MU 25	OT 0230 - 1
UELST	215 - 47	2.9375					5.9449	1.0630		MU 25	OT 0230 - 2
UCT	215	2.9528					5.9449	1.0236		MU 26	OT 0231 - 1
UELT	215	2.9528					5.9449	1.0236		MU 26	OT 0231 - 2
UCST	215	2.9528					5.9449	1.0630		MU 25	OT 0232 - 1
UCT	215 - 48	3.0000					5.9449	1.0236		MU 26	OT 0233 - 1
UELT	215 - 48	3.0000					5.9449	1.0236		MU 26	OT 0233 - 2
UCST	215 - 48	3.0000					5.9449	1.0630		MU 25	OT 0234 - 1
UCT	216 - 49	3.0625					6.4961	1.0236		MU 26	OT 0235 - 1
UCT	216 - 50	3.1250					6.4961	1.0236		MU 26	OT 0236 - 1
UCT	216	3.1496					6.4961	1.0236		MU 26	OT 0237 - 1
UCT	216 - 51	3.1875					6.4961	1.0236		MU 26	OT 0238 - 1
UCT	217 - 52	3.2500					6.8110	1.1811		MU 26	OT 0239 - 1
UCT	217 - 53	3.3125					6.8110	1.1811		MU 26	OT 0240 - 1
UCT	217	3.3465					6.8110	1.1811		MU 26	OT 0241 - 1
UCT	217 - 55	3.4375					6.8110	1.1811		MU 26	OT 0242 - 1

■ ID = Inside Diameter ■ OD = Outside Diameter ■ W = Width ■ SE = Shaft Center to Elevation ■ PS = Pipe ?
 ■ SH = Shaft Center to High ■ SW = Shaft Center to Width

HYC Number	ID		OD		IW		Graphic	Figure No.	Group No.
	in	mm	in	mm	in	mm			
SB 201	0.4724	12.00	1.5748	40.00	0.8661	22.00		MU 30	IB 0001 - 1
UC 201	0.4724	12.00	1.8504	47.00	1.2205	31.00		MU 31	IB 0002 - 1
SA 201	0.4724	12.00	1.5748	40.00	1.1220	28.50		MU 29	IB 0003 - 1
UEL 201	0.4724	12.00	1.8504	47.00	1.7126	43.50		MU 34	IB 0004 - 1
SB 201 - 8	0.5000	12.70	1.5748	40.00	0.8661	22.00		MU 30	IB 0005 - 1
UC 201 - 8	0.5000	12.70	1.8504	47.00	1.2205	31.00		MU 31	IB 0006 - 1
SA 201 - 8	0.5000	12.70	1.5748	40.00	1.1220	28.50		MU 29	IB 0007 - 1
UEL 201 - 8	0.5000	12.70	1.8504	47.00	1.7126	43.50		MU 34	IB 0008 - 1
SB 202 - 9	0.5625	14.29	1.5748	40.00	0.8661	22.00		MU 30	IB 0009 - 1
UC 202 - 9	0.5625	14.29	1.8504	47.00	1.2205	31.00		MU 31	IB 0010 - 1
SA 202 - 9	0.5625	14.29	1.5748	40.00	1.1220	28.50		MU 29	IB 0011 - 1
UEL 202 - 9	0.5625	14.29	1.8504	47.00	1.7126	43.50		MU 34	IB 0012 - 1
SB 202	0.5906	15.00	1.5748	40.00	0.8661	22.00		MU 30	IB 0013 - 1
UC 202	0.5906	15.00	1.8504	47.00	1.2205	31.00		MU 31	IB 0014 - 1
SA 202	0.5906	15.00	1.5748	40.00	1.1220	28.50		MU 29	IB 0015 - 1
UEL 202	0.5906	15.00	1.8504	47.00	1.7126	43.50		MU 34	IB 0016 - 1
SB 202 - 10	0.6250	15.88	1.5748	40.00	0.8661	22.00		MU 30	IB 0017 - 1
UC 202 - 10	0.6250	15.88	1.8504	47.00	1.2205	31.00		MU 31	IB 0018 - 1
SA 202 - 10	0.6250	15.88	1.5748	40.00	1.1220	28.50		MU 29	IB 0019 - 1
UEL 202 - 10	0.6250	15.88	1.8504	47.00	1.7126	43.50		MU 34	IB 0020 - 1
SB 203	0.6693	17.00	1.5748	40.00	0.8661	22.00		MU 30	IB 0021 - 1
UC 203	0.6693	17.00	1.8504	47.00	1.2205	31.00		MU 31	IB 0022 - 1
SA 203	0.6693	17.00	1.5748	40.00	1.1220	28.50		MU 29	IB 0023 - 1
UEL 203	0.6693	17.00	1.8504	47.00	1.7126	43.50		MU 34	IB 0024 - 1
SB 203 - 11	0.6875	17.46	1.5748	40.00	0.8661	22.00		MU 30	IB 0025 - 1
UC 203 - 11	0.6875	17.46	1.8504	47.00	1.2205	31.00		MU 31	IB 0026 - 1
SA 203 - 11	0.6875	17.46	1.5748	40.00	1.1220	28.50		MU 29	IB 0027 - 1
UEL 203 - 11	0.6875	17.46	1.8504	47.00	1.7126	43.50		MU 34	IB 0028 - 1
SB 204 - 12	0.7500	19.05	1.8504	47.00	0.9843	25.00		MU 30	IB 0029 - 1
UC 204 - 12	0.7500	19.05	1.8504	47.00	1.2205	31.00		MU 31	IB 0030 - 1
SA 204 - 12	0.7500	19.05	1.8504	47.00	1.1614	29.50		MU 29	IB 0031 - 1
UEL 204 - 12	0.7500	19.05	1.8504	47.00	1.7126	43.50		MU 34	IB 0032 - 1
SB 204	0.7874	20.00	1.8504	47.00	0.9843	25.00		MU 30	IB 0033 - 1
UC 204	0.7874	20.00	1.8504	47.00	1.2205	31.00		MU 31	IB 0034 - 1
SA 204	0.7874	20.00	1.8504	47.00	1.1614	29.50		MU 29	IB 0035 - 1
UEL 204	0.7874	20.00	1.8504	47.00	1.7126	43.50		MU 34	IB 0036 - 1
UK 205	0.7874	20.00	2.0472	52.00	0.8268	21.00		MU 35	IB 0037 - 1
SB 205 - 13	0.8125	20.64	2.0472	52.00	1.0630	27.00		MU 30	IB 0038 - 1
UC 205 - 13	0.8125	20.64	2.0472	52.00	1.3386	34.00		MU 31	IB 0039 - 1
SA 205 - 13	0.8125	20.64	2.0472	52.00	1.2008	30.50		MU 29	IB 0040 - 1
UEL 205 - 13	0.8125	20.64	2.0472	52.00	1.7441	44.30		MU 34	IB 0041 - 1
UC X05 - 13	0.8125	20.64	2.4409	62.00	1.5000	38.10		MU 33	IB 0042 - 1

INSERT BEARINGS











































DIMENSIONS

HYC Number	ID		OD		IW		Graphic	Figure No.	Group No.
	in	mm	in	mm	in	mm			
UC 305 - 13	0.8125	20.64	2.4409	62.00	1.4961	38.00		MU 32	IB 0043 - 1
SB 205 - 14	0.8750	22.23	2.0472	52.00	1.0630	27.00		MU 30	IB 0044 - 1
UC 205 - 14	0.8750	22.23	2.0472	52.00	1.3386	34.00		MU 31	IB 0045 - 1
SA 205 - 14	0.8750	22.23	2.0472	52.00	1.2008	30.50		MU 29	IB 0046 - 1
UEL 205 - 14	0.8750	22.23	2.0472	52.00	1.7441	44.30		MU 34	IB 0047 - 1
UC X05 - 14	0.8750	22.23	2.4409	62.00	1.5000	38.10		MU 33	IB 0048 - 1
UC 305 - 14	0.8750	22.23	2.4409	62.00	1.4961	38.00		MU 32	IB 0049 - 1
SB 205 - 15	0.9375	23.81	2.0472	52.00	1.0630	27.00		MU 30	IB 0050 - 1
UC 205 - 15	0.9375	23.81	2.0472	52.00	1.3386	34.00		MU 31	IB 0051 - 1
SA 205 - 15	0.9375	23.81	2.0472	52.00	1.2008	30.50		MU 29	IB 0052 - 1
UEL 205 - 15	0.9375	23.81	2.0472	52.00	1.7441	44.30		MU 34	IB 0053 - 1
UC X05 - 15	0.9375	23.81	2.4409	62.00	1.5000	38.10		MU 33	IB 0054 - 1
UC 305 - 15	0.9375	23.81	2.4409	62.00	1.4961	38.00		MU 32	IB 0055 - 1
SB 205	0.9843	25.00	2.0472	52.00	1.0630	27.00		MU 30	IB 0056 - 1
UC 205	0.9843	25.00	2.0472	52.00	1.3386	34.00		MU 31	IB 0057 - 1
SA 205	0.9843	25.00	2.0472	52.00	1.2008	30.50		MU 29	IB 0058 - 1
UEL 205	0.9843	25.00	2.0472	52.00	1.7441	44.30		MU 34	IB 0059 - 1
UK 206	0.9843	25.00	2.4409	62.00	0.9843	25.00		MU 35	IB 0060 - 1
UC X05	0.9843	25.00	2.4409	62.00	1.5000	38.10		MU 33	IB 0061 - 1
UC 305	0.9843	25.00	2.4409	62.00	1.4961	38.00		MU 32	IB 0062 - 1
SB 205 - 16	1.0000	25.40	2.0472	52.00	1.0630	27.00		MU 30	IB 0063 - 1
UC 205 - 16	1.0000	25.40	2.0472	52.00	1.3386	34.00		MU 31	IB 0064 - 1
SA 205 - 16	1.0000	25.40	2.0472	52.00	1.2008	30.50		MU 29	IB 0065 - 1
UEL 205 - 16	1.0000	25.40	2.0472	52.00	1.7441	44.30		MU 34	IB 0066 - 1
UC X05 - 16	1.0000	25.40	2.4409	62.00	1.5000	38.10		MU 33	IB 0067 - 1
UC 305 - 16	1.0000	25.40	2.4409	62.00	1.4961	38.00		MU 32	IB 0068 - 1
SB 206 - 17	1.0625	26.99	2.4409	62.00	1.1417	29.00		MU 30	IB 0069 - 1
UC 206 - 17	1.0625	26.99	2.4409	62.00	1.5000	38.10		MU 31	IB 0070 - 1
SA 206 - 17	1.0625	26.99	2.4409	62.00	1.3346	33.90		MU 29	IB 0071 - 1
UEL 206 - 17	1.0625	26.99	2.4409	62.00	1.9016	48.30		MU 34	IB 0072 - 1
UC X06 - 17	1.0625	26.99	2.8346	72.00	1.6890	42.90		MU 33	IB 0073 - 1
UC 306 - 17	1.0625	26.99	2.8346	72.00	1.6929	43.00		MU 32	IB 0074 - 1
SB 206 - 18	1.1250	28.58	2.4409	62.00	1.1417	29.00		MU 30	IB 0075 - 1
UC 206 - 18	1.1250	28.58	2.4409	62.00	1.5000	38.10		MU 31	IB 0076 - 1
SA 206 - 18	1.1250	28.58	2.4409	62.00	1.3346	33.90		MU 29	IB 0077 - 1
UEL 206 - 18	1.1250	28.58	2.4409	62.00	1.9016	48.30		MU 34	IB 0078 - 1
UC X06 - 18	1.1250	28.58	2.8346	72.00	1.6890	42.90		MU 33	IB 0079 - 1
UC 306 - 18	1.1250	28.58	2.8346	72.00	1.6929	43.00		MU 32	IB 0080 - 1
SB 206	1.1811	30.00	2.4409	62.00	1.1417	29.00		MU 30	IB 0081 - 1
UC 206	1.1811	30.00	2.4409	62.00	1.5000	38.10		MU 31	IB 0082 - 1
SA 206	1.1811	30.00	2.4409	62.00	1.3346	33.90		MU 29	IB 0083 - 1
UEL 206	1.1811	30.00	2.4409	62.00	1.9016	48.30		MU 34	IB 0084 - 1

DIMENSIONS

INSERT BEARINGS

DIMENSIONS

HYC Number	ID		OD		IW		Graphic	Figure No.	Group No.
	in	mm	in	mm	in	mm			
UK 207	1.1811	30.00	2.8346	72.00	1.0630	27.00		MU 35	IB 0085 - 1
UC X06	1.1811	30.00	2.8346	72.00	1.6890	42.90		MU 33	IB 0086 - 1
UC 306	1.1811	30.00	2.8346	72.00	1.6929	43.00		MU 32	IB 0087 - 1
SB 206 - 19	1.1875	30.16	2.4409	62.00	1.1417	29.00		MU 30	IB 0088 - 1
UC 206 - 19	1.1875	30.16	2.4409	62.00	1.5000	38.10		MU 31	IB 0089 - 1
SA 206 - 19	1.1875	30.16	2.4409	62.00	1.3346	33.90		MU 29	IB 0090 - 1
UEL 206 - 19	1.1875	30.16	2.4409	62.00	1.9016	48.30		MU 34	IB 0091 - 1
UC X06 - 19	1.1875	30.16	2.8346	72.00	1.6890	42.90		MU 33	IB 0092 - 1
UC 306 - 19	1.1875	30.16	2.8346	72.00	1.6929	43.00		MU 32	IB 0093 - 1
SB 206 - 20	1.2500	31.75	2.4409	62.00	1.1417	29.00		MU 30	IB 0094 - 1
UC 206 - 20	1.2500	31.75	2.4409	62.00	1.5000	38.10		MU 31	IB 0095 - 1
SA 206 - 20	1.2500	31.75	2.4409	62.00	1.3346	33.90		MU 29	IB 0096 - 1
UEL 206 - 20	1.2500	31.75	2.4409	62.00	1.9016	48.30		MU 34	IB 0097 - 1
UC X06 - 20	1.2500	31.75	2.8346	72.00	1.6890	42.90		MU 33	IB 0098 - 1
UC 306 - 20	1.2500	31.75	2.8346	72.00	1.6929	43.00		MU 32	IB 0099 - 1
SB 207 - 20	1.2500	31.75	2.8346	72.00	1.2598	32.00		MU 30	IB 0100 - 1
UC 207 - 20	1.2500	31.75	2.8346	72.00	1.6890	42.90		MU 31	IB 0101 - 1
SA 207 - 20	1.2500	31.75	2.8346	72.00	1.4764	37.50		MU 29	IB 0102 - 1
UEL 207 - 20	1.2500	31.75	2.8346	72.00	2.0118	51.10		MU 34	IB 0103 - 1
UC X07 - 20	1.2500	31.75	3.1496	80.00	1.9370	49.20		MU 33	IB 0104 - 1
UC 307 - 20	1.2500	31.75	3.1496	80.00	1.8898	48.00		MU 32	IB 0105 - 1
SB 207 - 21	1.3125	33.34	2.8346	72.00	1.2598	32.00		MU 30	IB 0106 - 1
UC 207 - 21	1.3125	33.34	2.8346	72.00	1.6890	42.90		MU 31	IB 0107 - 1
SA 207 - 21	1.3125	33.34	2.8346	72.00	1.4764	37.50		MU 29	IB 0108 - 1
UEL 207 - 21	1.3125	33.34	2.8346	72.00	2.0118	51.10		MU 34	IB 0109 - 1
UC X07 - 21	1.3125	33.34	3.1496	80.00	1.9370	49.20		MU 33	IB 0110 - 1
UC 307 - 21	1.3125	33.34	3.1496	80.00	1.8898	48.00		MU 32	IB 0111 - 1
SB 207 - 22	1.3750	34.93	2.8346	72.00	1.2598	32.00		MU 30	IB 0112 - 1
UC 207 - 22	1.3750	34.93	2.8346	72.00	1.6890	42.90		MU 31	IB 0113 - 1
SA 207 - 22	1.3750	34.93	2.8346	72.00	1.4764	37.50		MU 29	IB 0114 - 1
UEL 207 - 22	1.3750	34.93	2.8346	72.00	2.0118	51.10		MU 34	IB 0115 - 1
UC X07 - 22	1.3750	34.93	3.1496	80.00	1.9370	49.20		MU 33	IB 0116 - 1
UC 307 - 22	1.3750	34.93	3.1496	80.00	1.8898	48.00		MU 32	IB 0117 - 1
SB 207	1.3780	35.00	2.8346	72.00	1.2598	32.00		MU 30	IB 0118 - 1
UC 207	1.3780	35.00	2.8346	72.00	1.6890	42.90		MU 31	IB 0119 - 1
SA 207	1.3780	35.00	2.8346	72.00	1.4764	37.50		MU 29	IB 0120 - 1
UEL 207	1.3780	35.00	2.8346	72.00	2.0118	51.10		MU 34	IB 0121 - 1
UK 208	1.3780	35.00	3.1496	80.00	1.1417	29.00		MU 35	IB 0122 - 1
UC X07	1.3780	35.00	3.1496	80.00	1.9370	49.20		MU 33	IB 0123 - 1
UC 307	1.3780	35.00	3.1496	80.00	1.8898	48.00		MU 32	IB 0124 - 1
SB 207 - 23	1.4375	36.51	2.8346	72.00	1.2598	32.00		MU 30	IB 0125 - 1
UC 207 - 23	1.4375	36.51	2.8346	72.00	1.6890	42.90		MU 31	IB 0126 - 1

INSERT BEARINGS











































DIMENSIONS

HYC Number	ID		OD		IW		Graphic	Figure No.	Group No.
	in	mm	in	mm	in	mm			
SA 207 - 23	1.4375	36.51	2.8346	72.00	1.4764	37.50		MU 29	IB 0127 - 1
UEL 207 - 23	1.4375	36.51	2.8346	72.00	2.0118	51.10		MU 34	IB 0128 - 1
UC X07 - 23	1.4375	36.51	3.1496	80.00	1.9370	49.20		MU 33	IB 0129 - 1
UC 307 - 23	1.4375	36.51	3.1496	80.00	1.8898	48.00		MU 32	IB 0130 - 1
SB 208 - 24	1.5000	38.10	3.1496	80.00	1.3386	34.00		MU 30	IB 0131 - 1
UC 208 - 24	1.5000	38.10	3.1496	80.00	1.9370	49.20		MU 31	IB 0132 - 1
SA 208 - 24	1.5000	38.10	3.1496	80.00	1.5945	40.50		MU 29	IB 0133 - 1
UEL 208 - 24	1.5000	38.10	3.1496	80.00	2.2165	56.30		MU 34	IB 0134 - 1
UC X08 - 24	1.5000	38.10	3.3465	85.00	1.9370	49.20		MU 33	IB 0135 - 1
UC 308 - 24	1.5000	38.10	3.5433	90.00	2.0472	52.00		MU 32	IB 0136 - 1
SB 208 - 25	1.5625	39.69	3.1496	80.00	1.3386	34.00		MU 30	IB 0137 - 1
UC 208 - 25	1.5625	39.69	3.1496	80.00	1.9370	49.20		MU 31	IB 0138 - 1
SA 208 - 25	1.5625	39.69	3.1496	80.00	1.5945	40.50		MU 29	IB 0139 - 1
UEL 208 - 25	1.5625	39.69	3.1496	80.00	2.2165	56.30		MU 34	IB 0140 - 1
UC X08 - 25	1.5625	39.69	3.3465	85.00	1.9370	49.20		MU 33	IB 0141 - 1
UC 308 - 25	1.5625	39.69	3.5433	90.00	2.0472	52.00		MU 32	IB 0142 - 1
SB 208	1.5748	40.00	3.1496	80.00	1.3386	34.00		MU 30	IB 0143 - 1
UC 208	1.5748	40.00	3.1496	80.00	1.9370	49.20		MU 31	IB 0144 - 1
SA 208	1.5748	40.00	3.1496	80.00	1.5945	40.50		MU 29	IB 0145 - 1
UEL 208	1.5748	40.00	3.1496	80.00	2.2165	56.30		MU 34	IB 0146 - 1
UK 209	1.5748	40.00	3.3465	85.00	1.1811	30.00		MU 35	IB 0147 - 1
UC X08	1.5748	40.00	3.3465	85.00	1.9370	49.20		MU 33	IB 0148 - 1
UC 308	1.5748	40.00	3.5433	90.00	2.0472	52.00		MU 32	IB 0149 - 1
UC 209 - 26	1.6250	41.28	3.3465	85.00	1.9370	49.20		MU 31	IB 0150 - 1
SA 209 - 26	1.6250	41.28	3.3465	85.00	1.6614	42.20		MU 29	IB 0151 - 1
UEL 209 - 26	1.6250	41.28	3.3465	85.00	2.2165	56.30		MU 34	IB 0152 - 1
UC X09 - 26	1.6250	41.28	3.5433	90.00	2.0315	51.60		MU 33	IB 0153 - 1
UC 309 - 26	1.6250	41.28	3.9370	100.00	2.2441	57.00		MU 32	IB 0154 - 1
UC 209 - 27	1.6875	42.86	3.3465	85.00	1.9370	49.20		MU 31	IB 0155 - 1
SA 209 - 27	1.6875	42.86	3.3465	85.00	1.6614	42.20		MU 29	IB 0156 - 1
UEL 209 - 27	1.6875	42.86	3.3465	85.00	2.2165	56.30		MU 34	IB 0157 - 1
UC X09 - 27	1.6875	42.86	3.5433	90.00	2.0315	51.60		MU 33	IB 0158 - 1
UC 309 - 27	1.6875	42.86	3.9370	100.00	2.2441	57.00		MU 32	IB 0159 - 1
UC 209 - 28	1.7500	44.45	3.3465	85.00	1.9370	49.20		MU 31	IB 0160 - 1
SA 209 - 28	1.7500	44.45	3.3465	85.00	1.6614	42.20		MU 29	IB 0161 - 1
UEL 209 - 28	1.7500	44.45	3.3465	85.00	2.2165	56.30		MU 34	IB 0162 - 1
UC X09 - 28	1.7500	44.45	3.5433	90.00	2.0315	51.60		MU 33	IB 0163 - 1
UC 309 - 28	1.7500	44.45	3.9370	100.00	2.2441	57.00		MU 32	IB 0164 - 1
UC 209	1.7717	45.00	3.3465	85.00	1.9370	49.20		MU 31	IB 0165 - 1
SA 209	1.7717	45.00	3.3465	85.00	1.6614	42.20		MU 29	IB 0166 - 1
UEL 209	1.7717	45.00	3.3465	85.00	2.2165	56.30		MU 34	IB 0167 - 1
UK 210	1.7717	45.00	3.5433	90.00	1.2205	31.00		MU 35	IB 0168 - 1

DIMENSIONS











































INSERT BEARINGS

DIMENSIONS

HYC Number	ID		OD		IW		Graphic	Figure No.	Group No.
	in	mm	in	mm	in	mm			
UC X09	1.7717	45.00	3.5433	90.00	2.0315	51.60		MU 33	IB 0169 - 1
UC 309	1.7717	45.00	3.9370	100.00	2.2441	57.00		MU 32	IB 0170 - 1
UC 210 - 29	1.8125	46.04	3.5433	90.00	2.0315	51.60		MU 31	IB 0171 - 1
SA 210 - 29	1.8125	46.04	3.5433	90.00	1.7205	43.70		MU 29	IB 0172 - 1
UEL 210 - 29	1.8125	46.04	3.5433	90.00	2.4685	62.70		MU 34	IB 0173 - 1
UC X10 - 29	1.8125	46.04	3.9370	100.00	2.1890	55.60		MU 33	IB 0174 - 1
UC 310 - 29	1.8125	46.04	4.3307	110.00	2.4016	61.00		MU 32	IB 0175 - 1
UC 210 - 30	1.8750	47.63	3.5433	90.00	2.0315	51.60		MU 31	IB 0176 - 1
SA 210 - 30	1.8750	47.63	3.5433	90.00	1.7205	43.70		MU 29	IB 0177 - 1
UEL 210 - 30	1.8750	47.63	3.5433	90.00	2.4685	62.70		MU 34	IB 0178 - 1
UC X10 - 30	1.8750	47.63	3.9370	100.00	2.1890	55.60		MU 33	IB 0179 - 1
UC 310 - 30	1.8750	47.63	4.3307	110.00	2.4016	61.00		MU 32	IB 0180 - 1
UC 210 - 31	1.9375	49.21	3.5433	90.00	2.0315	51.60		MU 31	IB 0181 - 1
SA 210 - 31	1.9375	49.21	3.5433	90.00	1.7205	43.70		MU 29	IB 0182 - 1
UEL 210 - 31	1.9375	49.21	3.5433	90.00	2.4685	62.70		MU 34	IB 0183 - 1
UC X10 - 31	1.9375	49.21	3.9370	100.00	2.1890	55.60		MU 33	IB 0184 - 1
UC 310 - 31	1.9375	49.21	4.3307	110.00	2.4016	61.00		MU 32	IB 0185 - 1
UC 210	1.9685	50.00	3.5433	90.00	2.0315	51.60		MU 31	IB 0186 - 1
SA 210	1.9685	50.00	3.5433	90.00	1.7205	43.70		MU 29	IB 0187 - 1
UEL 210	1.9685	50.00	3.5433	90.00	2.4685	62.70		MU 34	IB 0188 - 1
UK 211	1.9685	50.00	3.9370	100.00	1.2992	33.00		MU 35	IB 0189 - 1
UC X10	1.9685	50.00	3.9370	100.00	2.1890	55.60		MU 33	IB 0190 - 1
UC 310	1.9685	50.00	4.3307	110.00	2.4016	61.00		MU 32	IB 0191 - 1
UC 210 - 32	2.0000	50.80	3.5433	90.00	2.0315	51.60		MU 31	IB 0192 - 1
SA 210 - 32	2.0000	50.80	3.5433	90.00	1.7205	43.70		MU 29	IB 0193 - 1
UEL 210 - 32	2.0000	50.80	3.5433	90.00	2.4685	62.70		MU 34	IB 0194 - 1
UC X10 - 32	2.0000	50.80	3.9370	100.00	2.1890	55.60		MU 33	IB 0195 - 1
UC 310 - 32	2.0000	50.80	4.3307	110.00	2.4016	61.00		MU 32	IB 0196 - 1
UC 211 - 32	2.0000	50.80	3.9370	100.00	2.1890	55.60		MU 31	IB 0197 - 1
SA 211 - 32	2.0000	50.80	3.9370	100.00	1.9055	48.40		MU 29	IB 0198 - 1
UEL 211 - 32	2.0000	50.80	3.9370	100.00	2.8071	71.30		MU 34	IB 0199 - 1
UC X11 - 32	2.0000	50.80	4.3307	110.00	2.5630	65.10		MU 33	IB 0200 - 1
UC 311 - 32	2.0000	50.80	4.7244	120.00	2.5984	66.00		MU 32	IB 0201 - 1
UC 211 - 33	2.0625	52.39	3.9370	100.00	2.1890	55.60		MU 31	IB 0202 - 1
SA 211 - 33	2.0625	52.39	3.9370	100.00	1.9055	48.40		MU 29	IB 0203 - 1
UEL 211 - 33	2.0625	52.39	3.9370	100.00	2.8071	71.30		MU 34	IB 0204 - 1
UC X11 - 33	2.0625	52.39	4.3307	110.00	2.5630	65.10		MU 33	IB 0205 - 1
UC 311 - 33	2.0625	52.39	4.7244	120.00	2.5984	66.00		MU 32	IB 0206 - 1
UC 211 - 34	2.1250	53.98	3.9370	100.00	2.1890	55.60		MU 31	IB 0207 - 1
SA 211 - 34	2.1250	53.98	3.9370	100.00	1.9055	48.40		MU 29	IB 0208 - 1
UEL 211 - 34	2.1250	53.98	3.9370	100.00	2.8071	71.30		MU 34	IB 0209 - 1
UC X11 - 34	2.1250	53.98	4.3307	110.00	2.5630	65.10		MU 33	IB 0210 - 1

INSERT BEARINGS











































DIMENSIONS

HYC Number	ID		OD		IW		Graphic	Figure No.	Group No.
	in	mm	in	mm	in	mm			
UC 311 - 34	2.1250	53.98	4.7244	120.00	2.5984	66.00		MU 32	IB 0211 - 1
UC 211	2.1654	55.00	3.9370	100.00	2.1890	55.60		MU 31	IB 0212 - 1
SA 211	2.1654	55.00	3.9370	100.00	1.9055	48.40		MU 29	IB 0213 - 1
UEL 211	2.1654	55.00	3.9370	100.00	2.8071	71.30		MU 34	IB 0214 - 1
UK 212	2.1654	55.00	4.3307	110.00	1.4173	36.00		MU 35	IB 0215 - 1
UC X11	2.1654	55.00	4.3307	110.00	2.5630	65.10		MU 33	IB 0216 - 1
UC 311	2.1654	55.00	4.7244	120.00	2.5984	66.00		MU 32	IB 0217 - 1
UC 211 - 35	2.1875	55.56	3.9370	100.00	2.1890	55.60		MU 31	IB 0218 - 1
SA 211 - 35	2.1875	55.56	3.9370	100.00	1.9055	48.40		MU 29	IB 0219 - 1
UEL 211 - 35	2.1875	55.56	3.9370	100.00	2.8071	71.30		MU 34	IB 0220 - 1
UC X11 - 35	2.1875	55.56	4.3307	110.00	2.5630	65.10		MU 33	IB 0221 - 1
UC 311 - 35	2.1875	55.56	4.7244	120.00	2.5984	66.00		MU 32	IB 0222 - 1
UC 212 - 36	2.2500	57.15	4.3307	110.00	2.5630	65.10		MU 31	IB 0223 - 1
UEL 212 - 36	2.2500	57.15	4.3307	110.00	3.0591	77.70		MU 34	IB 0224 - 1
UC X12 - 36	2.2500	57.15	4.7244	120.00	2.5630	65.10		MU 33	IB 0225 - 1
UC 312 - 36	2.2500	57.15	5.1181	130.00	2.7953	71.00		MU 32	IB 0226 - 1
UC 212 - 37	2.3125	58.74	4.3307	110.00	2.5630	65.10		MU 31	IB 0227 - 1
UEL 212 - 37	2.3125	58.74	4.3307	110.00	3.0591	77.70		MU 34	IB 0228 - 1
UC X12 - 37	2.3125	58.74	4.7244	120.00	2.5630	65.10		MU 33	IB 0229 - 1
UC 312 - 37	2.3125	58.74	5.1181	130.00	2.7953	71.00		MU 32	IB 0230 - 1
UC 212	2.3622	60.00	4.3307	110.00	2.5630	65.10		MU 31	IB 0231 - 1
UEL 212	2.3622	60.00	4.3307	110.00	3.0591	77.70		MU 34	IB 0232 - 1
UK 213	2.3622	60.00	4.7244	120.00	1.4173	36.00		MU 35	IB 0233 - 1
UC X12	2.3622	60.00	4.7244	120.00	2.5630	65.10		MU 33	IB 0234 - 1
UC 312	2.3622	60.00	5.1181	130.00	2.7953	71.00		MU 32	IB 0235 - 1
UC 212 - 38	2.3750	60.33	4.3307	110.00	2.5630	65.10		MU 31	IB 0236 - 1
UEL 212 - 38	2.3750	60.33	4.3307	110.00	3.0591	77.70		MU 34	IB 0237 - 1
UC X12 - 38	2.3750	60.33	4.7244	120.00	2.5630	65.10		MU 33	IB 0238 - 1
UC 312 - 38	2.3750	60.33	5.1181	130.00	2.7953	71.00		MU 32	IB 0239 - 1
UC 212 - 39	2.4375	61.91	4.3307	110.00	2.5630	65.10		MU 31	IB 0240 - 1
UEL 212 - 39	2.4375	61.91	4.3307	110.00	3.0591	77.70		MU 34	IB 0241 - 1
UC X12 - 39	2.4375	61.91	4.7244	120.00	2.5630	65.10		MU 33	IB 0242 - 1
UC 312 - 39	2.4375	61.91	5.1181	130.00	2.7953	71.00		MU 32	IB 0243 - 1
UC 213 - 40	2.5000	63.50	4.7244	120.00	2.5630	65.10		MU 31	IB 0244 - 1
UEL 213 - 40	2.5000	63.50	4.7244	120.00	3.3740	85.70		MU 34	IB 0245 - 1
UC X13 - 40	2.5000	63.50	4.9213	125.00	2.9370	74.60		MU 33	IB 0246 - 1
UC 313 - 40	2.5000	63.50	5.5118	140.00	2.9528	75.00		MU 32	IB 0247 - 1
UC 213	2.5591	65.00	4.7244	120.00	2.5630	65.10		MU 31	IB 0248 - 1
UEL 213	2.5591	65.00	4.7244	120.00	3.3740	85.70		MU 34	IB 0249 - 1
UC X13	2.5591	65.00	4.9213	125.00	2.9370	74.60		MU 33	IB 0250 - 1
UC 313	2.5591	65.00	5.5118	140.00	2.9528	75.00		MU 32	IB 0251 - 1
UC 213 - 41	2.5625	65.09	4.7244	120.00	2.5630	65.10		MU 31	IB 0252 - 1

DIMENSIONS













INSERT BEARINGS

DIMENSIONS

HYC Number	ID		OD		IW		Graphic	Figure No.	Group No.
	in	mm	in	mm	in	mm			
UEL 213 - 41	2.5625	65.09	4.7244	120.00	3.3740	85.70		MU 34	IB 0253 - 1
UC X13 - 41	2.5625	65.09	4.9213	125.00	2.9370	74.60		MU 33	IB 0254 - 1
UC 313 - 41	2.5625	65.09	5.5118	140.00	2.9528	75.00		MU 32	IB 0255 - 1
UC 214 - 42	2.6250	66.68	4.9213	125.00	2.9370	74.60		MU 31	IB 0256 - 1
UEL 214 - 42	2.6250	66.68	4.9213	125.00	3.3740	85.70		MU 34	IB 0257 - 1
UC X14 - 42	2.6250	66.68	5.1181	130.00	3.0630	77.80		MU 33	IB 0258 - 1
UC 314 - 42	2.6250	66.68	5.9055	150.00	3.0709	78.00		MU 32	IB 0259 - 1
UC 214 - 43	2.6875	68.26	4.9213	125.00	2.9370	74.60		MU 31	IB 0260 - 1
UEL 214 - 43	2.6875	68.26	4.9213	125.00	3.3740	85.70		MU 34	IB 0261 - 1
UC X14 - 43	2.6875	68.26	5.1181	130.00	3.0630	77.80		MU 33	IB 0262 - 1
UC 314 - 43	2.6875	68.26	5.9055	150.00	3.0709	78.00		MU 32	IB 0263 - 1
UC 214 - 44	2.7500	69.85	4.9213	125.00	2.9370	74.60		MU 31	IB 0264 - 1
UEL 214 - 44	2.7500	69.85	4.9213	125.00	3.3740	85.70		MU 34	IB 0265 - 1
UC X14 - 44	2.7500	69.85	5.1181	130.00	3.0630	77.80		MU 33	IB 0266 - 1
UC 314 - 44	2.7500	69.85	5.9055	150.00	3.0709	78.00		MU 32	IB 0267 - 1
UC 214	2.7559	70.00	4.9213	125.00	2.9370	74.60		MU 31	IB 0268 - 1
UEL 214	2.7559	70.00	4.9213	125.00	3.3740	85.70		MU 34	IB 0269 - 1
UC X14	2.7559	70.00	5.1181	130.00	3.0630	77.80		MU 33	IB 0270 - 1
UC 314	2.7559	70.00	5.9055	150.00	3.0709	78.00		MU 32	IB 0271 - 1
UC 215 - 45	2.8125	71.44	5.1181	130.00	3.0630	77.80		MU 31	IB 0272 - 1
UEL 215 - 45	2.8125	71.44	5.1181	130.00	3.6260	92.10		MU 34	IB 0273 - 1
UC X15 - 45	2.8125	71.44	5.5118	140.00	3.2520	82.60		MU 33	IB 0274 - 1
UC 315 - 45	2.8125	71.44	6.2992	160.00	3.2283	82.00		MU 32	IB 0275 - 1
UC 215 - 46	2.8750	73.03	5.1181	130.00	3.0630	77.80		MU 31	IB 0276 - 1
UEL 215 - 46	2.8750	73.03	5.1181	130.00	3.6260	92.10		MU 34	IB 0277 - 1
UC X15 - 46	2.8750	73.03	5.5118	140.00	3.2520	82.60		MU 33	IB 0278 - 1
UC 315 - 46	2.8750	73.03	6.2992	160.00	3.2283	82.00		MU 32	IB 0279 - 1
UC 215 - 47	2.9375	74.61	5.1181	130.00	3.0630	77.80		MU 31	IB 0280 - 1
UEL 215 - 47	2.9375	74.61	5.1181	130.00	3.6260	92.10		MU 34	IB 0281 - 1
UC X15 - 47	2.9375	74.61	5.5118	140.00	3.2520	82.60		MU 33	IB 0282 - 1
UC 315 - 47	2.9375	74.61	6.2992	160.00	3.2283	82.00		MU 32	IB 0283 - 1
UC 215	2.9528	75.00	5.1181	130.00	3.0630	77.80		MU 31	IB 0284 - 1
UEL 215	2.9528	75.00	5.1181	130.00	3.6260	92.10		MU 34	IB 0285 - 1
UC X15	2.9528	75.00	5.5118	140.00	3.2520	82.60		MU 33	IB 0286 - 1
UC 315	2.9528	75.00	6.2992	160.00	3.2283	82.00		MU 32	IB 0287 - 1
UC 215 - 48	3.0000	76.20	5.1181	130.00	3.0630	77.80		MU 31	IB 0288 - 1
UEL 215 - 48	3.0000	76.20	5.1181	130.00	3.6260	92.10		MU 34	IB 0289 - 1
UC X15 - 48	3.0000	76.20	5.5118	140.00	3.2520	82.60		MU 33	IB 0290 - 1
UC 315 - 48	3.0000	76.20	6.2992	160.00	3.2283	82.00		MU 32	IB 0291 - 1
UC 216 - 49	3.0625	77.79	5.5118	140.00	3.2520	82.60		MU 31	IB 0292 - 1
UC X16 - 49	3.0625	77.79	5.9055	150.00	3.3740	85.70		MU 33	IB 0293 - 1
UC 316 - 49	3.0625	77.79	6.6929	170.00	3.3858	86.00		MU 32	IB 0294 - 1

INSERT BEARINGS

DIMENSIONS

HYC Number	ID		OD		IW		Graphic	Figure No.	Group No.
	in	mm	in	mm	in	mm			
UC 216 - 50	3.1250	79.38	5.5118	140.00	3.2520	82.60		MU 31	IB 0295 - 1
UC X16 - 50	3.1250	79.38	5.9055	150.00	3.3740	85.70		MU 33	IB 0296 - 1
UC 316 - 50	3.1250	79.38	6.6929	170.00	3.3858	86.00		MU 32	IB 0297 - 1
UC 216	3.1496	80.00	5.5118	140.00	3.2520	82.60		MU 31	IB 0298 - 1
UC X16	3.1496	80.00	5.9055	150.00	3.3740	85.70		MU 33	IB 0299 - 1
UC 316	3.1496	80.00	6.6929	170.00	3.3858	86.00		MU 32	IB 0300 - 1
UC 216 - 51	3.1875	80.96	5.5118	140.00	3.2520	82.60		MU 31	IB 0301 - 1
UC 217 - 52	3.2500	82.55	5.9055	150.00	3.3740	85.70		MU 31	IB 0302 - 1
UC 217 - 53	3.3125	84.14	5.9055	150.00	3.3740	85.70		MU 31	IB 0303 - 1
UC 217	3.3465	85.00	5.9055	150.00	3.3740	85.70		MU 31	IB 0304 - 1
UC 217 - 55	3.4375	87.31	5.9055	150.00	3.3740	85.70		MU 31	IB 0305 - 1
UC 218 - 56	3.5000	88.90	6.2992	160.00	3.7795	96.0		MU 31	IB 0306 - 1
UC 218	3.5433	90.00	6.2992	160.00	3.7795	96.0		MU 31	IB 0307 - 1



INTERCHANGEABLE GUIDE

Figure MU 01
Standard Duty Pillow Blocks - Pressed Steel Housing
Eccentric Locking Collar Type, Set Screws Type

0.4724 in	ID	12.00 mm
0.8740 in	SB	22.20 mm
2.6772 in	BC fix	68.00 mm

Group No. PB 0001 - 1

SLB	SAPP 201
FYH	SAPP 201 F
INA	PB 12
NSK	ENPP 201
NTN	AELPP 201 W 3
RHP	LPB 12 EC
SKF	S 12 FM

Group No. PB 0001 - 2

SLB	SBPP 201
ASAHI	BPP 1
FYH	SBPP 201 F
INA	PBY 12
NACHI	BPP 1
NSK	UBPP 201
NTN	ASPP 201

Figure MU 03
Standard Duty Pillow Blocks - Cast Housing
Eccentric Locking Collar Type, Set Screws Type

0.4724 in	ID	12.00 mm
1.1890 in	SB	30.20 mm
3.7795 in	BC fix	96.00 mm
3.5433 in	BC min	90.00 mm
4.0157 in	BC max	102.00 mm

Group No. PB 0002 - 1

SLB	UCP 201
ASAHI	UCP 201
FYH	UCP 201
INA	RASEY 12
NACHI	UCP 201
NSK	UCP 201
NTN	UCP 201 D 1

Group No. PB 0002 - 2

SLB	UELP 201
FYH	NAP 201

Figure MU 04
Standard Duty Pillow Blocks - Cast Housing
Set Screws Type

0.4724 in	ID	12.00 mm
1.1890 in	SB	30.20 mm
2.0472 in	BC fix	52.00 mm

Group No. PB 0003 - 1

SLB	UCPA 201
ASAHI	UCPA 201
FYH	UCPA 201
NACHI	UCPA 201
NSK	UCPA 201
NTN	UCUP 201 D 1

Figure MU 01
Standard Duty Pillow Blocks - Pressed Steel Housing
Eccentric Locking Collar Type, Set Screws Type

0.5000 in	ID	12.70 mm
0.8740 in	SB	22.20 mm
2.6772 in	BC fix	68.00 mm

Group No. PB 0004 - 1

SLB	SAPP 201 - 8
FAFNIR	PB - 1/2
FYH	SAPP 201 - 8 F
INA	PB 1/2"
NTN	AELPP 201 - 008 W 3
RHP	LPB 1/2 EC
SKF	S 1/2 FM

Group No. PB 0004 - 2

SLB	SBPP 201 - 8
ASAHI	BPP 1 - 8
FYH	SBPP 201 - 8 F
NACHI	BPP 1 - 8
NTN	ASPP 201 - 008

Figure MU 03
Standard Duty Pillow Blocks - Cast Housing
Eccentric Locking Collar Type, Set Screws Type

0.5000 in	ID	12.70 mm
1.1890 in	SB	30.20 mm
3.7795 in	BC fix	96.00 mm
3.5433 in	BC min	90.00 mm
4.0157 in	BC max	102.00 mm

Group No. PB 0005 - 1

SLB	UCP 201 - 8
ASAHI	UCP 201 - 8
FYH	UCP 201 - 8
INA	RASEY 1/2"
LINK - BELT	P 3 - U 2 B 08 N
NACHI	UCP 201 - 8
NSK	UCP 201 - 8 S
NTN	UCP 201 - 008 D 1
SEALMASTER	NP - 8

Group No. PB 0005 - 2

SLB	UELP 201 - 8
FYH	NAP 201 - 8
LINK - BELT	P 3 - Y 2 B 08 N

Figure MU 04
Standard Duty Pillow Blocks - Cast Housing
Set Screws Type

0.5000 in	ID	12.70 mm
1.1890 in	SB	30.20 mm
2.0472 in	BC fix	52.00 mm

Group No. PB 0006 - 1

SLB	UCPA 201 - 8
ASAHI	UCPA 201 - 8
BROWNING	VTBS - 208
FYH	UCPA 201 - 8
INA	RSHEY 1/2"
NACHI	UCPA 201 - 8
NSK	UCPA 201 - 8 S
NTN	UCUP 201 - 008 D 1

Figure MU 01
Standard Duty Pillow Blocks - Pressed Steel Housing
Eccentric Locking Collar Type, Set Screws Type

0.5625 in	ID	14.29 mm
0.8740 in	SB	22.20 mm
2.6772 in	BC fix	68.00 mm

Group No. PB 0007 - 1

SLB	SAPP 202 - 9
FAFNIR	PB - 9/16
NTN	AELPP 202 - 009 W 3

Group No. PB 0007 - 2

SLB	SBPP 202 - 9
ASAHI	BPP 2 - 9
NACHI	BPP 2 - 9
NTN	ASPP 202 - 009

Figure MU 03
Standard Duty Pillow Blocks - Cast Housing
Eccentric Locking Collar Type, Set Screws Type

0.5625 in	ID	14.29 mm
1.1890 in	SB	30.20 mm
3.7795 in	BC fix	96.00 mm
3.5433 in	BC min	90.00 mm
4.0157 in	BC max	102.00 mm

Group No. PB 0008 - 1

SLB	UCP 202 - 9
ASAHI	UCP 202 - 9
NACHI	UCP 202 - 9
NTN	UCP 202 - 009 D 1
SEALMASTER	NP - 9

Figure MU 04
Standard Duty Pillow Blocks - Cast Housing
Set Screws Type

0.5625 in	ID	14.29 mm
1.1890 in	SB	30.20 mm
2.0472 in	BC fix	52.00 mm

Group No. PB 0009 - 1

SLB	UCPA 202 - 9
ASAHI	UCPA 202 - 9
NACHI	UCPA 202 - 9
NTN	UCUP 202 - 009 D 1

Figure MU 01

Standard Duty Pillow Blocks - Pressed Steel Housing
Eccentric Locking Collar Type, Set Screws Type

0.5906 in	ID	15.00 mm
0.8740 in	SB	22.20 mm
2.6772 in	BC fix	68.00 mm

Group No. PB 0010 - 1

SLB	SAPP 202
FAG	SB 16203/15
FYH	SAPP 202 F
INA	PB 15
NSK	ENPP 202
NTN	AELPP 202 W 3
RHP	LPB 15 EC
SKF	S 15 FM

Group No. PB 0010 - 2

SLB	SBPP 202
ASAHI	BPP 2
FYH	SBPP 202 F
INA	PBY 15
NACHI	BPP 2
NSK	UBPP 202
NTN	ASPP 202

Figure MU 03

Standard Duty Pillow Blocks - Cast Housing
Eccentric Locking Collar Type, Set Screws Type

0.5906 in	ID	15.00 mm
1.1890 in	SB	30.20 mm
3.7795 in	BC fix	96.00 mm
3.5433 in	BC min	90.00 mm
4.0157 in	BC max	102.00 mm

Group No. PB 0011 - 1

SLB	UCP 202
ASAHI	UCP 202
FYH	UCP 202
INA	RASEY 15
NACHI	UCP 202
NSK	UCP 202
NTN	UCP 202 D 1

Group No. PB 0011 - 2

SLB	UERP 202
FYH	NAP 202
INA	RASE 15

Figure MU 04

Standard Duty Pillow Blocks - Cast Housing
Set Screws Type

0.5906 in	ID	15.00 mm
1.1890 in	SB	30.20 mm
2.0472 in	BC fix	52.00 mm

Group No. PB 0012 - 1

SLB	UCPA 202
ASAHI	UCPA 202
FYH	UCPA 202
NACHI	UCPA 202
NSK	UCPA 202
NTN	UCUP 202 D 1

Figure MU 01

Standard Duty Pillow Blocks - Pressed Steel Housing
Eccentric Locking Collar Type, Set Screws Type

0.6250 in	ID	15.88 mm
0.8740 in	SB	22.20 mm
2.6772 in	BC fix	68.00 mm

Group No. PB 0013 - 1

SLB	SAPP 202 - 10
FAFNIR	PB - 5/8
FYH	SAPP 202 - 10 F
INA	PB 5/8"
KOYO	SP 010 A
NTN	AELPP 202 - 010 W 3
RHP	LPB 5/8 EC
SKF	S 5/8 FM

Group No. PB 0013 - 2

SLB	SBPP 202 - 10
ASAHI	BPP 2 - 10
FYH	SBPP 202 - 10 F
NACHI	BPP 2 - 10
NTN	ASPP 202 - 010

Figure MU 03

Standard Duty Pillow Blocks - Cast Housing
Eccentric Locking Collar Type, Set Screws Type

0.6250 in	ID	15.88 mm
1.1890 in	SB	30.20 mm
3.7795 in	BC fix	96.00 mm
3.5433 in	BC min	90.00 mm
4.0157 in	BC max	102.00 mm

Group No. PB 0014 - 1

SLB	UCP 202 - 10
ASAHI	UCP 202 - 10
FYH	UCP 202 - 10
INA	RASEY 5/8"
LINK - BELT	P 3 - U 210 N
NACHI	UCP 202 - 10
NSK	UCP 202 - 10 S
NTN	UCP 202 - 010 D 1
SEALMASTER	NP - 10

Group No. PB 0014 - 2

SLB	UERP 202 - 10
FYH	NAP 202 - 10
INA	RASE 5/8"
LINK - BELT	P 3 - Y 210 N

Figure MU 04

Standard Duty Pillow Blocks - Cast Housing
Set Screws Type

0.6250 in	ID	15.88 mm
1.1890 in	SB	30.20 mm
2.0472 in	BC fix	52.00 mm

Group No. PB 0015 - 1

SLB	UCPA 202 - 10
ASAHI	UCPA 202 - 10
BROWNING	VTBS - 210
FYH	UCPA 202 - 10
INA	RSHEY 5/8"
NACHI	UCPA 202 - 10
NSK	UCPA 202 - 10 S
NTN	UCUP 202 - 010 D 1

Figure MU 01

Standard Duty Pillow Blocks - Pressed Steel Housing
Eccentric Locking Collar Type, Set Screws Type

0.6693 in	ID	17.00 mm
0.8740 in	SB	22.20 mm
2.6772 in	BC fix	68.00 mm

Group No. PB 0016 - 1

SLB	SAPP 203
FAFNIR	PB - 17
FAG	SB 16203
FYH	SAPP 203 F
INA	PB 17
KOYO	SP 011 MA
NSK	ENPP 203
NTN	AELPP 203 W 3
RHP	LPB 17 EC
SKF	S 17 FM
SNR	40 MVA + 1217 - 17 ECG

Group No. PB 0016 - 2		
SLB	SBPP 203	
ASAHI	BPP 3	
FYH	SBPP 203 F	
INA	PBY 17	
KOYO	SP 11 M	
NACHI	BPP 3	
NSK	UBPP 203	
NTN	ASPP 203	

Figure MU 03
Standard Duty Pillow Blocks - Cast Housing
Eccentric Locking Collar Type, Set Screws Type

0.6693 in	ID	17.00 mm
1.1890 in	SB	30.20 mm
3.7795 in	BC fix	96.00 mm
3.5433 in	BC min	90.00 mm
4.0157 in	BC max	102.00 mm

Group No. PB 0017 - 1		
SLB	UCP 203	
ASAHI	UCP 203	
FYH	UCP 203	
INA	RASEY 17	
LINK - BELT	P 3 - U 2 M 17 N	
NACHI	UCP 203	
NSK	UCP 203	
NTN	UCP 203 D 1	

Group No. PB 0017 - 2		
SLB	UEL P 203	
FYH	NAP 203	
INA	RASE 17	

Figure MU 04
Standard Duty Pillow Blocks - Cast Housing
Set Screws Type

0.6693 in	ID	17.00 mm
1.1890 in	SB	30.20 mm
2.0472 in	BC fix	52.00 mm

Group No. PB 0018 - 1		
SLB	UCPA 203	
ASAHI	UCPA 203	
FYH	UCPA 203	
NACHI	UCPA 203	
NSK	UCPA 203	
NTN	UCUP 203 D 1	

Figure MU 01
Standard Duty Pillow Blocks - Pressed Steel Housing
Eccentric Locking Collar Type, Set Screws Type

0.6875 in	ID	17.46 mm
0.8740 in	SB	22.20 mm
2.6772 in	BC fix	68.00 mm

Group No. PB 0019 - 1		
SLB	SAPP 203 - 11	
NTN	AELPP 203 - 011 W 3	
SKF	S 11/16 FM	

Group No. PB 0019 - 2		
SLB	SBPP 203 - 11	
ASAHI	BPP 3 - 11	
NACHI	BPP 3 - 11	
NTN	ASPP 203 - 011	

Figure MU 03
Standard Duty Pillow Blocks - Cast Housing
Eccentric Locking Collar Type, Set Screws Type

0.6875 in	ID	17.46 mm
1.1890 in	SB	30.20 mm
3.7795 in	BC fix	96.00 mm
3.5433 in	BC min	90.00 mm
4.0157 in	BC max	102.00 mm

Group No. PB 0020 - 1		
SLB	UCP 203 - 11	
ASAHI	UCP 203 - 11	
LINK - BELT	P 3 - U 211 N	
NACHI	UCP 203 - 11	
NTN	UCP 203 - 011 D 1	
SEALMASTER	NP - 11	

Group No. PB 0020 - 2		
SLB	UEL P 203 - 11	
LINK - BELT	P 3 - Y 211 N	

Figure MU 04
Standard Duty Pillow Blocks - Cast Housing
Set Screws Type

0.6875 in	ID	17.46 mm
1.1890 in	SB	30.20 mm
2.0472 in	BC fix	52.00 mm

Group No. PB 0021 - 1		
SLB	UCPA 203 - 11	
ASAHI	UCPA 203 - 11	
NACHI	UCPA 203 - 11	
NTN	UCUP 203 - 011 D 1	

Figure MU 01
Standard Duty Pillow Blocks - Pressed Steel Housing
Eccentric Locking Collar Type, Set Screws Type

0.7500 in	ID	19.05 mm
1.0000 in	SB	25.40 mm
2.9921 in	BC fix	76.00 mm

Group No. PB 0022 - 1		
SLB	SAPP 204 - 12	
FAFNIR	PB - 3/4	
FAG	SB 16204.012	
FYH	SAPP 204 - 12 F	
INA	PB 3/4"	
KOYO	SP 012 A	
NTN	AELPP 204 - 012 W 3	
RHP	LPB 3/4 EC	
SKF	S 3/4 FM	

Group No. PB 0022 - 2		
SLB	SBPP 204 - 12	
ASAHI	BPP 4 - 12	
FYH	SBPP 204 - 12 F	
NACHI	BPP 4 - 12	
NTN	ASPP 204 - 012	
RHP	LPB 3/4 A	

Figure MU 04
Standard Duty Pillow Blocks - Cast Housing
Set Screws Type

0.7500 in	ID	19.05 mm
1.1890 in	SB	30.20 mm
2.0472 in	BC fix	52.00 mm

Group No. PB 0023 - 1		
SLB	UCPA 204 - 12	
ASAHI	UCPA 204 - 12	
BROWNING	VTBS - 212	
FYH	UCPA 204 - 12	
NACHI	UCPA 204 - 12	
NSK	UCPA 204 - 12 S	
NTN	UCUP 204 - 012 D 1	
RHP	SNP 3/4	
SKF	SYF 3/4 TM	

Figure MU 02
Standard Duty Pillow Blocks - Cast Housing
Eccentric Locking Collar Type, Set Screws Type

0.7500 in	ID	19.05 mm
1.2520 in	SB	31.80 mm
3.8583 in	BC fix	98.00 mm
3.7008 in	BC min	94.00 mm
4.0157 in	BC max	102.00 mm

Group No. PB 0024 - 1		
SLB	UCAK 204 - 12	
ASAHI	UCLP 204 - 12	
BROWNING	VPLS - 212	
FYH	SL 204 - 12	

INA	RAKY 3/4"
LINK - BELT	PL 3 - U 212 N
NACHI	UCLP 204 - 12
NTN	UCPL 204 - 012 D 1
RHP	SL 3/4
SEALMASTER	NPL - 12
SKF	SYH 3/4 TM

Group No. PB 0024 - 2

SLB	UELAK 204 - 12
BROWNING	VPLE - 212
FAFNIR	RAK - 3/4
INA	RAK 3/4"
LINK - BELT	PL 3 - Y 212 N
NTN	UELPL 204 - 012 D1 W 3
RHP	SL 3/4 DEC
SKF	SYH 3/4 WM

Group No. PB 0024 - 3

SLB	SAAK 204 - 12
BROWNING	VPLE - 112
FAFNIR	VAK - 3/4
INA	PAK 3/4"
LINK - BELT	PL 3 - W 212 U
NTN	AELPL 204 - 012 W 3
RHP	SL 3/4 EC
SKF	SYH 3/4 FM

Group No. PB 0024 - 4

SLB	SBAK 204 - 12
BROWNING	VPLS - 112
LINK - BELT	PL 3 - S 212 E
NTN	ASPL 204 - 012
RHP	SL 3/4 A

Figure MU 03

*Standard Duty Pillow Blocks - Cast Housing
Eccentric Locking Collar Type, Set Screws Type*



0.7500 in	ID	19.05 mm
1.3110 in	SB	33.30 mm
3.7795 in	BC fix	96.00 mm
3.5433 in	BC min	90.00 mm
4.0157 in	BC max	102.00 mm

Group No. PB 0025 - 1

SLB	UCP 204 - 12
ASAHI	UCP 204 - 12
BROWNING	VPS - 212
FAFNIR	RASC - 3/4
FAG	SG 56204.012
FYH	UCP 204 - 12
INA	RASEY 3/4"
KOYO	UCP 204 - 12
LINK - BELT	P 3 - U 212 N
NACHI	UCP 204 - 12
NSK	UCP 204 - 12 S
NTN	UCP 204 - 012 D 1

RHP	NP 3/4
SEALMASTER	NP - 12
SKF	SY 3/4 TM

Group No. PB 0025 - 2

SLB	UEL204 - 12
BROWNING	VPE - 212
FAFNIR	RAS - 3/4
FAG	SG 36204 B
FYH	NAP 204 - 12
INA	RASE 3/4"
KOYO	GAP 1012 B
LINK - BELT	P 3 - Y 212 N
NACHI	UGP 204 - 12 + ER
NTN	UEL204 - 012 D1 W 3
RHP	NP 3/4 DEC
SKF	SY 3/4 WM

Group No. PB 0025 - 3

SLB	SAP 204 - 12
BROWNING	VPE - 112
FAFNIR	VAS - 3/4
FAG	SG 16204.012
INA	PASE 3/4"
KOYO	GARAP 012 A
LINK - BELT	P 3 - W 212 U
RHP	NP 3/4 EC
SKF	SY 3/4 FM

Group No. PB 0025 - 4

SLB	SBP 204 - 12
ASAHI	BP 204 - 12
BROWNING	VPS - 112
FAFNIR	SAS - 3/4
LINK - BELT	P 3 - S 212 E
NACHI	BP 204 - 12
RHP	NP 3/4 A

Figure MU 01

*Standard Duty Pillow Blocks - Pressed Steel Housing
Eccentric Locking Collar Type, Set Screws Type*



0.7874 in	ID	20.00 mm
1.0000 in	SB	25.40 mm
2.9921 in	BC fix	76.00 mm

Group No. PB 0026 - 1

SLB	SAPP 204
FAFNIR	PB - 20
FAG	SB 16204
FYH	SAPP 204 F
INA	PB 20
KOYO	SP 012 MA
NSK	ENPP 204
NTN	AELPP 204 W 3
RHP	LPB 20 EC
SKF	S 20 FM
SNR	47 MVA + 1220 - 20 ECG

Group No. PB 0026 - 2

SLB	SBPP 204
ASAHI	BPP 4
FYH	SBPP 204 F
INA	PBY 20
KOYO	SP 12 M
NACHI	BPP 4
NSK	UBPP 204
NTN	ASPP 204
RHP	LPB 20 A
SNR	47 MVA + 1220 - 20 G

Figure MU 04

*Standard Duty Pillow Blocks - Cast Housing
Set Screws Type*



0.7874 in	ID	20.00 mm
1.1890 in	SB	30.20 mm
2.0472 in	BC fix	52.00 mm

Group No. PB 0027 - 1

SLB	UCPA 204
ASAHI	UCPA 204
FYH	UCPA 204
NACHI	UCPA 204
NSK	UCPA 204
NTN	UCUP 204 D 1
RHP	SNP 20
SKF	SYF 20 TM

Figure MU 02

*Standard Duty Pillow Blocks - Cast Housing
Eccentric Locking Collar Type, Set Screws Type*



0.7874 in	ID	20.00 mm
1.2520 in	SB	31.80 mm
3.8583 in	BC fix	98.00 mm
3.7008 in	BC min	94.00 mm
4.0157 in	BC max	102.00 mm

Group No. PB 0028 - 1

SLB	UCAK 204
ASAHI	UCLP 204
FYH	SL 204
INA	RAKY 20
LINK - BELT	PL 3 - U 2 M 20 N
NACHI	UCLP 204
NTN	UCPL 204 D 1
RHP	SL 20
SEALMASTER	NPL - 204
SNR	SL 20

Group No. PB 0028 - 2

SLB	UELAK 204
FAFNIR	RAK - 20
INA	RAK 20
NTN	UELPL 204 D 1 W 3
RHP	SL 20 DEC

Group No. PB 0028 - 3	
SLB	SAAK 204
FAFNIR	VAK - 20
INA	PAK 20
NTN	AELPL 204 W 3
RHP	SL 20 EC
SNR	SL 20 EC
Group No. PB 0028 - 4	
SLB	SBAK 204
NTN	ASPL 204
RHP	SL 20 A

Figure MU 03 		
<i>Standard Duty Pillow Blocks - Cast Housing</i>		
<i>Eccentric Locking Collar Type, Set Screws Type</i>		
0.7874 in	ID	20.00 mm
1.3110 in	SB	33.30 mm
3.7795 in	BC fix	96.00 mm
3.5433 in	BC min	90.00 mm
4.0157 in	BC max	102.00 mm

Group No. PB 0029 - 1	
SLB	UCP 204
ASAHI	UCP 204
FAFNIR	RASC - 20
FAG	SG 56204
FYH	UCP 204
INA	RASEY 20
KOYO	UCP 204
LINK - BELT	P 3 - U 2 M 20 N
NACHI	UCP 204
NSK	UCP 204
NTN	UCP 204 D 1
RHP	NP 20
SEALMASTER	NP - 204
SKF	SY 20 TM
SNR	NP 20

Group No. PB 0029 - 2	
SLB	UELPL 204
FAFNIR	RAS - 20
FYH	NAP 204
INA	RASE 20
KOYO	GAP 1012 MB
NACHI	UGP 204 + ER
NSK	EWP 204
NTN	UELPL 204 D 1 W 3
RHP	NP 20 DEC
SKF	SY 20 WM

Group No. PB 0029 - 3	
SLB	SAP 204
FAFNIR	VAS - 20
FAG	SG 16204
INA	PASE 20
KOYO	GARAP 012 MA

RHP	NP 20 EC
SKF	SY 20 FM
SNR	NP 20 EC
Group No. PB 0029 - 4	
SLB	SBP 204
ASAHI	BP 204
FAFNIR	SAS - 20
INA	PASEY 20
NACHI	BP 204
NSK	UBP 204 J
RHP	NP 20 A
SNR	NP 20 A

Figure MU 05 		
<i>Standard Duty Pillow Blocks - Cast Housing</i>		
<i>Adapter Type</i>		
0.7874 in	ID	20.00 mm
1.4370 in	SB	36.50 mm
4.1339 in	BC fix	105.00 mm
2.0866 in	BC min	53.00 mm
6.1811 in	BC max	157.00 mm

Group No. PB 0030 - 1	
SLB	UKP 205
ASAHI	UKP 205
FYH	UKP 205
NACHI	UKP 205
NSK	UKP 205
NTN	UKP 205 D 1
RHP	NP 1025 - 20 K

Figure MU 06 		
<i>Standard Duty Pillow Blocks - Cast Housing</i>		
<i>Adapter Type</i>		
0.7874 in	ID	20.00 mm
1.4370 in	SB	36.50 mm
2.0472 in	BC fix	52.00 mm

Group No. PB 0031 - 1	
SLB	UKPA 205
FYH	UKPA 205

Figure MU 01 		
<i>Standard Duty Pillow Blocks - Pressed Steel Housing</i>		
<i>Eccentric Locking Collar Type, Set Screws Type</i>		
0.8125 in	ID	20.64 mm
1.1260 in	SB	28.60 mm
3.3858 in	BC fix	86.00 mm

Group No. PB 0032 - 1	
SLB	SAPP 205 - 13
FAFNIR	PB - 13/16
KOYO	SP 013 A

NTN	AELPP 205 - 013 W 3
SKF	S 13/16 FM
Group No. PB 0032 - 2	
SLB	SBPP 205 - 13
NTN	ASPP 205 - 013

Figure MU 02 		
<i>Standard Duty Pillow Blocks - Cast Housing</i>		
<i>Eccentric Locking Collar Type, Set Screws Type</i>		
0.8125 in	ID	20.64 mm
1.3110 in	SB	33.30 mm
4.1339 in	BC fix	105.00 mm
3.9764 in	BC min	101.00 mm
4.2913 in	BC max	109.00 mm

Group No. PB 0033 - 1	
SLB	UCAK 205 - 13
NTN	UCPL 205 - 013 D 1
SEALMASTER	NPL - 13
SKF	SYH 13/16 TM

Group No. PB 0033 - 2	
SLB	UELAK 205 - 13
FAFNIR	RAK - 13/16
NTN	UELPL 205 - 013 D 1 W 3
SKF	SYH 13/16 WM

Group No. PB 0033 - 3	
SLB	SAAK 205 - 13
FAFNIR	VAK - 13/16
NTN	AELPL 205 - 013 W 3
SKF	SYH 13/16 FM

Group No. PB 0033 - 4	
SLB	SBAK 205 - 13
NTN	ASPL 205 - 013

Figure MU 03 		
<i>Standard Duty Pillow Blocks - Cast Housing</i>		
<i>Eccentric Locking Collar Type, Set Screws Type</i>		
0.8125 in	ID	20.64 mm
1.4370 in	SB	36.50 mm
4.1339 in	BC fix	105.00 mm
3.7795 in	BC min	96.00 mm
4.4882 in	BC max	114.00 mm

Group No. PB 0034 - 1	
SLB	UCP 205 - 13
FAFNIR	RASC - 13/16
KOYO	UCP 205 - 13
NTN	UCP 205 - 013 D 1
SEALMASTER	NP - 13
SKF	SY 13/16 TM

Group No. PB 0034 - 2

SLB	UELP 205 - 13
FAFNIR	RAS - 13/16
KOYO	GAP 1013 B
NTN	UELP 205 - 013 D 1 W 3
SKF	SY 13/16 WM

Group No. PB 0034 - 3

SLB	SAP 205 - 13
FAFNIR	VAS - 13/16
KOYO	GARAP 013 A
SKF	SY 13/16 FM

Figure MU 04

Standard Duty Pillow Blocks - Cast Housing
Set Screws Type



0.8125 in	ID	20.64 mm
1.4370 in	SB	36.50 mm
2.2047 in	BC fix	56.00 mm

Group No. PB 0035 - 1

SLB	UCPA 205 - 13
NTN	UCUP 205 - 013 D 1
SEALMASTER	TB - 13

Figure MU 07

Medium Duty Pillow Blocks - Cast Housing
Set Screws Type



0.8125 in	ID	20.64 mm
1.7480 in	SB	44.40 mm
4.6850 in	BC fix	119.00 mm
4.4488 in	BC min	113.00 mm
4.9213 in	BC max	125.00 mm

Group No. PB 0036 - 1

SLB	UCP X05 - 13
NTN	UCP X05 - 013 D 1

Figure MU 08

Heavy Duty Pillow Blocks - Cast Housing
Set Screws Type



0.8125 in	ID	20.64 mm
1.7717 in	SB	45.00 mm
5.1969 in	BC fix	132.00 mm
4.9606 in	BC min	126.00 mm
5.4331 in	BC max	138.00 mm

Group No. PB 0037 - 1

SLB	UCP 305 - 13
NTN	UCP 305 - 013 D 1

Figure MU 01

Standard Duty Pillow Blocks - Pressed Steel Housing
Eccentric Locking Collar Type, Set Screws Type



0.8750 in	ID	22.23 mm
1.1260 in	SB	28.60 mm
3.3858 in	BC fix	86.00 mm

Group No. PB 0038 - 1

SLB	SAPP 205 - 14
FAFNIR	PB - 7/8
FAG	SB 16205.014
FYH	SAPP 205 - 14 F
INA	PB 7/8"
KOYO	SP 014 A
NTN	AELPP 205 - 014 W 3
RHP	LPB 7/8 EC
SEALMASTER	SSP - 14 E
SKF	S 7/8 FM

Group No. PB 0038 - 2

SLB	SBPP 205 - 14
ASAHI	BPP 5 - 14
FYH	SBPP 205 - 14 F
NACHI	BPP 5 - 14
NTN	ASPP 205 - 014
SEALMASTER	SSP - 14

Figure MU 02

Standard Duty Pillow Blocks - Cast Housing
Eccentric Locking Collar Type, Set Screws Type



0.8750 in	ID	22.23 mm
1.3110 in	SB	33.30 mm
4.1339 in	BC fix	105.00 mm
3.9764 in	BC min	101.00 mm
4.2913 in	BC max	109.00 mm

Group No. PB 0039 - 1

SLB	UCAK 205 - 14
ASAHI	UCLP 205 - 14
BROWNING	VPLS - 214
FYH	SL 205 - 14
INA	RAKY 7/8"
LINK - BELT	PL 3 - U 214 N
NACHI	UCLP 205 - 14
NTN	UCPL 205 - 014 D 1
RHP	SL 7/8
SEALMASTER	NPL - 14
SKF	SYH 7/8 TM

Group No. PB 0039 - 2

SLB	UELAK 205 - 14
BROWNING	VPLE - 214
FAFNIR	RAK - 7/8
INA	RAK 7/8"
LINK - BELT	PL 3 - Y 214 N
NTN	UELPL 205 - 014 D 1 W 3
RHP	SL 7/8 DEC
SKF	SYH 7/8 WM

Group No. PB 0039 - 3

SLB	SAAK 205 - 14
BROWNING	VPLE - 114
FAFNIR	VAK - 7/8
INA	PAK 7/8"
LINK - BELT	PL 3 - W 214 U
NTN	AELPL 205 - 014 W 3
RHP	SL 7/8 EC
SKF	SYH 7/8 FM

Group No. PB 0039 - 4

SLB	SBAK 205 - 14
BROWNING	VPLS - 114
LINK - BELT	PL 3 - S 214 E
NTN	ASPL 205 - 014

Figure MU 03

Standard Duty Pillow Blocks - Cast Housing
Eccentric Locking Collar Type, Set Screws Type



0.8750 in	ID	22.23 mm
1.4370 in	SB	36.50 mm
4.1339 in	BC fix	105.00 mm
3.7795 in	BC min	96.00 mm
4.4882 in	BC max	114.00 mm

Group No. PB 0040 - 1

SLB	UCP 205 - 14
ASAHI	UCP 205 - 14
BROWNING	VPS - 214
FAFNIR	RASC - 7/8
FYH	UCP 205 - 14
INA	RASEY 7/8"
KOYO	UCP 205 - 14
LINK - BELT	P 3 - U 214 N
NACHI	UCP 205 - 14
NSK	UCP 205 - 14 S
NTN	UCP 205 - 014 D 1
RHP	NP 7/8
SEALMASTER	NP - 14
SKF	SY 7/8 TM

Group No. PB 0040 - 2

SLB	UELP 205 - 14
BROWNING	VPE - 214
FAFNIR	RAS - 7/8
FYH	NAP 205 - 14
INA	RASE 7/8"
KOYO	GAP 1014 B
LINK - BELT	P 3 - Y 214 N
NACHI	UGP 205 - 14 + ER
NTN	UELP 205 - 014 D 1 W 3
RHP	NP 7/8 DEC
SKF	SY 7/8 WM

Group No. PB 0040 - 3

SLB	SAP 205 - 14
BROWNING	VPE - 114

FAFNIR	VAS - 7/8
FAG	SG 16205.014
INA	PASE 7/8"
KOYO	GARAP 014 A
LINK - BELT	P 3 - W 214 U
RHP	NP 7/8 EC
SKF	SY 7/8 FM

Group No. PB 0040 - 4

SLB	SBP 205 - 14
ASAHI	BP 205 - 14
BROWNING	VPS - 114
FAFNIR	SAS - 7/8
LINK - BELT	P 3 - S 214 E
NACHI	BP 205 - 14

Figure MU 04

Standard Duty Pillow Blocks - Cast Housing
Set Screws Type



0.8750 in	ID	22.23 mm
1.4370 in	SB	36.50 mm
2.2047 in	BC fix	56.00 mm

Group No. PB 0041 - 1

SLB	UCPA 205 - 14
ASAHI	UCPA 205 - 14
BROWNING	VTBS - 214
FYH	UCPA 205 - 14
INA	RSHEY 7/8"
LINK - BELT	PT 3 - U 214 N
NACHI	UCPA 205 - 14
NSK	UCPA 205 - 14 S
NTN	UCUP 205 - 014 D 1
RHP	SNP 7/8
SEALMASTER	TB - 14
SKF	SYF 7/8 TM

Figure MU 07

Medium Duty Pillow Blocks - Cast Housing
Set Screws Type



0.8750 in	ID	22.23 mm
1.7480 in	SB	44.40 mm
4.6850 in	BC fix	119.00 mm
4.4488 in	BC min	113.00 mm
4.9213 in	BC max	125.00 mm

Group No. PB 0042 - 1

SLB	UCP X05 - 14
ASAHI	UCP X05 - 14
NTN	UCP X05 - 014 D 1

Figure MU 08

Heavy Duty Pillow Blocks - Cast Housing
Set Screws Type



0.8750 in	ID	22.23 mm
1.7717 in	SB	45.00 mm
5.1969 in	BC fix	132.00 mm
4.9606 in	BC min	126.00 mm
5.4331 in	BC max	138.00 mm

Group No. PB 0043 - 1

SLB	UCP 305 - 14
ASAHI	UCP 305 - 14
NSK	UCP 305 - 14 S
NTN	UCP 305 - 014 D 1

Figure MU 01

Standard Duty Pillow Blocks - Pressed Steel Housing
Eccentric Locking Collar Type, Set Screws Type



0.9375 in	ID	23.81 mm
1.1260 in	SB	28.60 mm
3.3858 in	BC fix	86.00 mm

Group No. PB 0044 - 1

SLB	SAPP 205 - 15
FAFNIR	PB - 15/16
KOYO	SP 015 A
NTN	AELPP 205 - 015 W 3
RHP	LPB 15/16 EC
SEALMASTER	SSP - 15 E
SKF	S 15/16 FM

Group No. PB 0044 - 2

SLB	SBPP 205 - 15
ASAHI	BPP 5 - 15
NACHI	BPP 5 - 15
NTN	ASPP 205 - 015
SEALMASTER	SSP - 15

Figure MU 02

Standard Duty Pillow Blocks - Cast Housing
Eccentric Locking Collar Type, Set Screws Type



0.9375 in	ID	23.81 mm
1.3110 in	SB	33.30 mm
4.1339 in	BC fix	105.00 mm
3.9764 in	BC min	101.00 mm
4.2913 in	BC max	109.00 mm

Group No. PB 0045 - 1

SLB	UCAK 205 - 15
ASAHI	UCLP 205 - 15
BROWNING	VPLS - 215
FYH	SL 205 - 15
LINK - BELT	PL 3 - U 215 N
NACHI	UCLP 205 - 15
NTN	UCPL 205 - 015 D 1
RHP	SL 15/16
SEALMASTER	NPL - 15
SKF	SYH 15/16 TM

Group No. PB 0045 - 2

SLB	UELAK 205 - 15
BROWNING	VPLE - 215
FAFNIR	RAK - 15/16
INA	RAK 15/16"
LINK - BELT	PL 3 - Y 215 N
NTN	UELPL 205 - 015 D 1 W 3
RHP	SL 15/16 DEC
SKF	SYH 15/16 WM

Group No. PB 0045 - 3

SLB	SAAK 205 - 15
BROWNING	VPLE - 115
FAFNIR	VAK - 15/16
LINK - BELT	PL 3 - W 215 U
NTN	AELPL 205 - 015 W 3
RHP	SL 15/16 EC
SKF	SYH 15/16 FM

Group No. PB 0045 - 4

SLB	SBAK 205 - 15
BROWNING	VPLS - 115
LINK - BELT	PL 3 - S 215 E
NTN	ASPL 205 - 015

Figure MU 03

Standard Duty Pillow Blocks - Cast Housing
Eccentric Locking Collar Type, Set Screws Type



0.9375 in	ID	23.81 mm
1.4370 in	SB	36.50 mm
4.1339 in	BC fix	105.00 mm
3.7795 in	BC min	96.00 mm
4.4882 in	BC max	114.00 mm

Group No. PB 0046 - 1

SLB	UCP 205 - 15
ASAHI	UCP 205 - 15
BROWNING	VPS - 215
FAFNIR	RASC - 15/16
FYH	UCP 205 - 15
KOYO	UCP 205 - 15
LINK - BELT	P 3 - U 215 N
NACHI	UCP 205 - 15
NTN	UCP 205 - 015 D 1
RHP	NP 15/16
SEALMASTER	NP - 15
SKF	SY 15/16 TM

Group No. PB 0046 - 2

SLB	UELPL 205 - 15
BROWNING	VPE - 215
FAFNIR	RAS - 15/16
FAG	SG 36205 B
FYH	NAP 205 - 15
INA	RASE 15/16"
KOYO	GAP 1015 B
LINK - BELT	P 3 - Y 215 N

NACHI	UGP 205 - 15 + ER
NTN	UELPL 205 - 015 D 1 W 3
RHP	NP 15/16 DEC
SKF	SY 15/16 WM

Group No. PB 0046 - 3

SLB	SAP 205 - 15
BROWNING	VPE - 115
FAFNIR	VAS - 15/16
KOYO	GARAP 015 A
LINK - BELT	P 3 - W 215 U
RHP	NP 15/16 EC
SKF	SY 15/16 FM

Group No. PB 0046 - 4

SLB	SBP 205 - 15
ASAHI	BP 205 - 15
BROWNING	VPS - 115
FAFNIR	SAS - 15/16
LINK - BELT	P 3 - S 215 E
NACHI	BP 205 - 15

Figure MU 04

*Standard Duty Pillow Blocks - Cast Housing
Set Screws Type*

0.9375 in	ID	23.81 mm
1.4370 in	SB	36.50 mm
2.2047 in	BC fix	56.00 mm

Group No. PB 0047 - 1

SLB	UCPA 205 - 15
ASAHI	UCPA 205 - 15
BROWNING	VTBS - 215
FYH	UCPA 205 - 15
LINK - BELT	PT 3 - U 215 N
NACHI	UCPA 205 - 15
NTN	UCUP 205 - 015 D 1
RHP	SN 15/16
SEALMASTER	TB - 15
SKF	SYF 15/16 TM

Figure MU 07

*Medium Duty Pillow Blocks - Cast Housing
Set Screws Type*

0.9375 in	ID	23.81 mm
1.7480 in	SB	44.40 mm
4.6850 in	BC fix	119.00 mm
4.4488 in	BC min	113.00 mm
4.9213 in	BC max	125.00 mm

Group No. PB 0048 - 1

SLB	UCP X05 - 15
ASAHI	UCP X05 - 15
NTN	UCP X05 - 015 D 1
SEALMASTER	MP - 15

Figure MU 08

*Heavy Duty Pillow Blocks - Cast Housing
Set Screws Type*

0.9375 in	ID	23.81 mm
1.7717 in	SB	45.00 mm
5.1969 in	BC fix	132.00 mm
4.9606 in	BC min	126.00 mm
5.4331 in	BC max	138.00 mm

Group No. PB 0049 - 1

SLB	UCP 305 - 15
NTN	UCP 305 - 015 D 1

Figure MU 01

*Standard Duty Pillow Blocks - Pressed Steel Housing
Eccentric Locking Collar Type, Set Screws Type*

0.9843 in	ID	25.00 mm
1.1260 in	SB	28.60 mm
3.3858 in	BC fix	86.00 mm

Group No. PB 0050 - 1

SLB	SAPP 205
FAFNIR	PB - 25
FAG	SB 16205
FYH	SAPP 205 F
INA	PB 25
KOYO	SP 100 MA
NSK	ENPP 205
NTN	AELPP 205 W 3
RHP	LPB 25 EC
SKF	S 25 FM
SNR	52 MVA + 1225 - 25 ECG

Group No. PB 0050 - 2

SLB	SBPP 205
ASAHI	BPP 5
FYH	SBPP 205 F
INA	PBY 25
KOYO	SP 16 M
NACHI	BPP 5
NSK	UBPP 205
NTN	ASPP 205
RHP	LPB 25 A
SEALMASTER	SSP - 205
SNR	52 MVA + 1225 - 25 G

Figure MU 02

*Standard Duty Pillow Blocks - Cast Housing
Eccentric Locking Collar Type, Set Screws Type*

0.9843 in	ID	25.00 mm
1.3110 in	SB	33.30 mm
4.1339 in	BC fix	105.00 mm
3.9764 in	BC min	101.00 mm
4.2913 in	BC max	109.00 mm

Group No. PB 0051 - 1

SLB	UCAK 205
ASAHI	UCLP 205
FYH	SL 205
INA	RAKY 25
LINK - BELT	PL 3 - U 2 M 25 N
NACHI	UCLP 205
NTN	UCPL 205 D 1
RHP	SL 25
SEALMASTER	NPL - 205
SNR	SL 25

Group No. PB 0051 - 2

SLB	UELAK 205
FAFNIR	RAK - 25
INA	RAK 25
NTN	UELPL 205 D 1 W 3
RHP	SL 25 DEC

Group No. PB 0051 - 3

SLB	SAAK 205
FAFNIR	VAK - 25
INA	PAK 25
NTN	AELPL 205 W 3
RHP	SL 25 EC
SNR	SL 25 EC

Group No. PB 0051 - 4

SLB	SBAK 205
NTN	ASPL 205
RHP	SL 25 A

Figure MU 03

*Standard Duty Pillow Blocks - Cast Housing
Eccentric Locking Collar Type, Set Screws Type*

0.9843 in	ID	25.00 mm
1.4370 in	SB	36.50 mm
4.1339 in	BC fix	105.00 mm
3.7795 in	BC min	96.00 mm
4.4882 in	BC max	114.00 mm

Group No. PB 0052 - 1

SLB	UCP 205
ASAHI	UCP 205
FAFNIR	RASC - 25
FAG	SG 56205
FYH	UCP 205
INA	RASEY 25
KOYO	UCP 205
LINK - BELT	P 3 - U 2 M 25 N
NACHI	UCP 205
NSK	UCP 205
NTN	UCP 205 D 1
RHP	NP 25
SEALMASTER	NP - 205
SKF	SY 25 TM
SNR	NP 25

Group No. PB 0052 - 2	
SLB	UEL205
FAFNIR	RAS - 25
FYH	NAP 205
INA	RASE 25
KOYO	GAP 1100 MB
NACHI	UGP 205 + ER
NSK	EWP 205
NTN	UEL205 D 1 W 3
RHP	NP 25 DEC
SKF	SY 25 WM

Group No. PB 0052 - 3	
SLB	SAP 205
FAFNIR	VAS - 25
FAG	SG 16205
INA	PASE 25
KOYO	GARAP 100 MA
RHP	NP 25 EC
SKF	SY 25 FM
SNR	NP 25 EC

Group No. PB 0052 - 4	
SLB	SBP 205
ASAHI	BP 205
FAFNIR	SAS - 25
INA	PASEY 25
KOYO	PBP 16 MJ
NACHI	BP 205
NSK	UBP 205 J
RHP	NP 25 A
SNR	NP 25 A

Figure MU 04	
<i>Standard Duty Pillow Blocks - Cast Housing</i>	
<i>Set Screws Type</i>	
0.9843 in	ID 25.00 mm
1.4370 in	SB 36.50 mm
2.2047 in	BC fix 56.00 mm

Group No. PB 0053 - 1	
SLB	UCPA 205
ASAHI	UCPA 205
FYH	UCPA 205
NACHI	UCPA 205
NSK	UCPA 205
NTN	UCUP 205 D 1
RHP	SNP 25
SEALMASTER	TB - 205
SKF	SYF 25 TM
SNR	SNP 25

Figure MU 05	
<i>Standard Duty Pillow Blocks - Cast Housing</i>	
<i>Adapter Type</i>	

0.9843 in	ID	25.00 mm
1.6890 in	SB	42.90 mm
4.7638 in	BC fix	121.00 mm
7.7559 in	BC min	197.00 mm
1.7717 in	BC max	45.00 mm

Group No. PB 0054 - 1	
SLB	UKP 206
ASAHI	UKP 206
FYH	UKP 206
NACHI	UKP 206
NSK	UKP 206
NTN	UKP 206 D 1
RHP	NP 1030 - 25 K

Figure MU 06	
<i>Standard Duty Pillow Blocks - Cast Housing</i>	
<i>Adapter Type</i>	
0.9843 in	ID 25.00 mm
1.6890 in	SB 42.90 mm
2.2047 in	BC fix 56.00 mm

Group No. PB 0055 - 1	
SLB	UKPA 206
FYH	UKPA 206

Figure MU 07	
<i>Medium Duty Pillow Blocks - Cast Housing</i>	
<i>Set Screws Type</i>	
0.9843 in	ID 25.00 mm
1.7480 in	SB 44.40 mm
4.6850 in	BC fix 119.00 mm
4.4488 in	BC min 113.00 mm
4.9213 in	BC max 125.00 mm

Group No. PB 0056 - 1	
SLB	UCP X05
ASAHI	UCP X05
FYH	UCP X05
NSK	UCP X05
NTN	UCP X05 D 1
RHP	MP 25
SEALMASTER	MP - 305

Figure MU 08	
<i>Heavy Duty Pillow Blocks - Cast Housing</i>	
<i>Set Screws Type</i>	
0.9843 in	ID 25.00 mm
1.7717 in	SB 45.00 mm
5.1969 in	BC fix 132.00 mm
4.9606 in	BC min 126.00 mm
5.4331 in	BC max 138.00 mm

Group No. PB 0057 - 1	
SLB	UCP 305
ASAHI	UCP 305
FYH	UCP 305
NSK	UCP 305
NTN	UCP 305 D 1

Figure MU 01	
<i>Standard Duty Pillow Blocks - Pressed Steel Housing</i>	
<i>Eccentric Locking Collar Type, Set Screws Type</i>	
1.0000 in	ID 25.40 mm
1.1260 in	SB 28.60 mm
3.3858 in	BC fix 86.00 mm

Group No. PB 0058 - 1	
SLB	SAPP 205 - 16
FAFNIR	PB - 1
FAG	SB 16205.100
FYH	SAPP 205 - 16 F
INA	PB 1"
KOYO	SP 100 A
NTN	AELPP 205 - 100 W 3
RHP	LPB 1 EC
SEALMASTER	SSP - 16 E
SKF	S 1 FM

Group No. PB 0058 - 2	
SLB	SBPP 205 - 16
ASAHI	BPP 5 - 16
FYH	SBPP 205 - 16 F
INA	PBY 1"
NACHI	BPP 5 - 16
NTN	ASPP 205 - 100
RHP	LPB 1 A
SEALMASTER	SSP - 16

Figure MU 02	
<i>Standard Duty Pillow Blocks - Cast Housing</i>	
<i>Eccentric Locking Collar Type, Set Screws Type</i>	
1.0000 in	ID 25.40 mm
1.3110 in	SB 33.30 mm
4.1339 in	BC fix 105.00 mm
3.9764 in	BC min 101.00 mm
4.2913 in	BC max 109.00 mm

Group No. PB 0059 - 1	
SLB	UCAK 205 - 16
ASAHI	UCLP 205 - 16
BROWNING	VPLS - 216
FYH	SL 205 - 16
INA	RAKY 1"
LINK - BELT	PL 3 - U 216 N
NACHI	UCLP 205 - 16
NTN	UCPL 205 - 100 D 1

RHP	SL 1
SEALMASTER	NPL - 16
SKF	SYH 1 TM

Group No. PB 0059 - 2

SLB	UELAK 205 - 16
BROWNING	VPLE - 216
FAFNIR	RAK - 1
INA	RAK 1"
LINK - BELT	PL 3 - Y 216 N
NTN	UELPL 205 - 100 D 1 W 3
RHP	SL 1 EDEC
SKF	SYH 1 WM

Group No. PB 0059 - 3

SLB	SAAK 205 - 16
BROWNING	VPLE - 116
FAFNIR	VAK - 1
INA	PAK 1"
LINK - BELT	PL 3 - W 216 U
NTN	AELPL 205 - 100 W 3
RHP	SL 1 EC
SKF	SYH 1 FM

Group No. PB 0059 - 4

SLB	SBAK 205 - 16
BROWNING	VPLS - 116
LINK - BELT	PL 3 - S 216 E
NTN	ASPL 205 - 100
RHP	SL 1 A

Figure MU 03

Standard Duty Pillow Blocks - Cast Housing
Eccentric Locking Collar Type, Set Screws Type

1.0000 in	ID	25.40 mm
1.4370 in	SB	36.50 mm
4.1339 in	BC fix	105.00 mm
3.7795 in	BC min	96.00 mm
4.4882 in	BC max	114.00 mm

Group No. PB 0060 - 1

SLB	UCP 205 - 16
ASAHI	UCP 205 - 16
BROWNING	VPS - 216
FAFNIR	RASC - 1
FAG	SG 56205.100
FYH	UCP 205 - 16
INA	RASEY 1"
KOYO	UCP 205 - 16
LINK - BELT	P 3 - U 216 N
NACHI	UCP 205 - 16 S
NSK	UCP 205 - 16 S
NTN	UCP 205 - 100 D 1
RHP	NP 1
SEALMASTER	NP - 16
SKF	SY 1 TM

Group No. PB 0060 - 2

SLB	UELP 205 - 16
BROWNING	VPE - 216
FAFNIR	RAS - 1
FYH	NAP 205 - 16
INA	RASE 1"
KOYO	GAP 1100 B
LINK - BELT	P 3 - Y 216 N
NACHI	UGP 205 - 16 + ER
NTN	UELP 205 - 100 D 1 W 3
RHP	NP 1 EDEC
SKF	SY 1 WM

Group No. PB 0060 - 3

SLB	SAP 205 - 16
BROWNING	VPE - 116
FAFNIR	VAS - 1
FAG	SG 16205.100
INA	PASE 1"
KOYO	GARAP 100 A
LINK - BELT	P 3 - W 216 U
RHP	NP 1 EC
SKF	SY 1 FM

Group No. PB 0060 - 4

SLB	SBP 205 - 16
ASAHI	BP 205 - 16
BROWNING	VPS - 116
FAFNIR	SAS - 1
LINK - BELT	P 3 - S 216 E
NACHI	BP 205 - 16
RHP	NP 1 A

Figure MU 04

Standard Duty Pillow Blocks - Cast Housing
Set Screws Type

1.0000 in	ID	25.40 mm
1.4370 in	SB	36.50 mm
2.2047 in	BC fix	56.00 mm

Group No. PB 0061 - 1

SLB	UCPA 205 - 16
ASAHI	UCPA 205 - 16
BROWNING	VTBS - 216
FYH	UCPA 205 - 16
INA	RSHEY 1"
LINK - BELT	PT 3 - U 216 N
NACHI	UCPA 205 - 16
NSK	UCPA 205 - 16 S
NTN	UCUP 205 - 100 D 1
RHP	SNP 1
SEALMASTER	TB - 16
SKF	SYF 1 TM

Figure MU 07

Medium Duty Pillow Blocks - Cast Housing
Set Screws Type

1.0000 in	ID	25.40 mm
1.7480 in	SB	44.40 mm
4.6850 in	BC fix	119.00 mm
4.4488 in	BC min	113.00 mm
4.9213 in	BC max	125.00 mm

Group No. PB 0062 - 1

SLB	UCP X05 - 16
ASAHI	UCP X05 - 16
BROWNING	VPS - 316
FYH	UCP X05 - 16
NTN	UCP X05 - 100 D 1
RHP	MP 1
SEALMASTER	MP - 16

Figure MU 08

Heavy Duty Pillow Blocks - Cast Housing
Set Screws Type

1.0000 in	ID	25.40 mm
1.7717 in	SB	45.00 mm
5.1969 in	BC fix	132.00 mm
4.9606 in	BC min	126.00 mm
5.4331 in	BC max	138.00 mm

Group No. PB 0063 - 1

SLB	UCP 305 - 16
FYH	UCP 305 - 16
NSK	UCP 305 - 16 S
NTN	UCP 305 - 100 D 1

Figure MU 01

Standard Duty Pillow Blocks - Pressed Steel Housing
Eccentric Locking Collar Type, Set Screws Type

1.0625 in	ID	26.99 mm
1.3110 in	SB	33.30 mm
3.7402 in	BC fix	95.00 mm

Group No. PB 0064 - 1

SLB	SAPP 206 - 17
FAFNIR	PB - 1 - 1/16
FAG	SB 16206.101
INA	PB 1 1/16"
NTN	AELPP 206 - 101 W 3
SKF	S 1 - 1/16 FM

Group No. PB 0064 - 2

SLB	SBPP 206 - 17
NTN	ASPP 206 - 101

Figure MU 02

Standard Duty Pillow Blocks - Cast Housing
Eccentric Locking Collar Type, Set Screws Type

1.0625 in	ID	26.99 mm
1.5630 in	SB	39.70 mm
4.7638 in	BC fix	121.00 mm
4.4882 in	BC min	114.00 mm
5.0394 in	BC max	128.00 mm

Group No. PB 0065 - 1

SLB	UCAK 206 - 17
ASAHI	UCLP 206 - 17
NACHI	UCLP 206 - 17
NTN	UCPL 206 - 101 D 1
SEALMASTER	NPL - 17
SKF	SYH 1 - 1/16 TM

Group No. PB 0065 - 2

SLB	UELAK 206 - 17
FAFNIR	RAK - 1 - 1/16
NTN	UELPL 206 - 101 D 1 W 3
SKF	SYH 1 - 1/16 WM

Group No. PB 0065 - 3

SLB	SAAK 206 - 17
FAFNIR	VAK - 1 - 1/16
INA	PAK 1 1/16"
NTN	AELPL 206 - 101 W 3
SKF	SYH 1 - 1/16 FM

Group No. PB 0065 - 4

SLB	SBAK 206 - 17
NTN	ASPL 206 - 101

Figure MU 03

*Standard Duty Pillow Blocks - Cast Housing
Eccentric Locking Collar Type, Set Screws Type*

1.0625 in	ID	26.99 mm
1.6890 in	SB	42.90 mm
4.7638 in	BC fix	121.00 mm
4.4882 in	BC min	114.00 mm
5.0394 in	BC max	128.00 mm

Group No. PB 0066 - 1

SLB	UCP 206 - 17
ASAHI	UCP 206 - 17
FAFNIR	RASC - 1 - 1/16
NACHI	UCP 206 - 17
NTN	UCP 206 - 101 D 1
SEALMASTER	NP - 17
SKF	SY 1 - 1/16 TM

Group No. PB 0066 - 2

SLB	UELPL 206 - 17
FAFNIR	RAS - 1 - 1/16
NTN	UELPL 206 - 101 D 1 W 3
SKF	SY 1 - 1/16 WM

Group No. PB 0066 - 3

SLB	SAP 206 - 17
FAFNIR	VAS - 1 - 1/16

FAG	SG 16206.101
INA	PASE 1 1/16"
SKF	SY 1 - 1/16 FM

Figure MU 04

*Standard Duty Pillow Blocks - Cast Housing
Set Screws Type*

1.0625 in	ID	26.99 mm
1.6890 in	SB	42.90 mm
2.5984 in	BC fix	66.00 mm

Group No. PB 0067 - 1

SLB	UCPA 206 - 17
ASAHI	UCPA 206 - 17
NACHI	UCPA 206 - 17
NTN	UCUP 206 - 101 D 1
SEALMASTER	TB - 17

Figure MU 07

*Medium Duty Pillow Blocks - Cast Housing
Set Screws Type*

1.0625 in	ID	26.99 mm
1.8740 in	SB	47.60 mm
5.0000 in	BC fix	127.00 mm
4.7638 in	BC min	121.00 mm
5.2362 in	BC max	133.00 mm

Group No. PB 0068 - 1

SLB	UCP X06 - 17
NTN	UCP X06 - 101 D 1

Figure MU 08

*Heavy Duty Pillow Blocks - Cast Housing
Set Screws Type*

1.0625 in	ID	26.99 mm
1.9685 in	SB	50.00 mm
5.5118 in	BC fix	140.00 mm
5.2756 in	BC min	134.00 mm
5.7480 in	BC max	146.00 mm

Group No. PB 0069 - 1

SLB	UCP 306 - 17
NTN	UCP 306 - 101 D 1

Figure MU 01

*Standard Duty Pillow Blocks - Pressed Steel Housing
Eccentric Locking Collar Type, Set Screws Type*

1.1250 in	ID	28.58 mm
1.3110 in	SB	33.30 mm
3.7402 in	BC fix	95.00 mm

Group No. PB 0070 - 1

SLB	SAPP 206 - 18
FAFNIR	PB - 1 - 1/8
FAG	SB 16206.102
FYH	SAPP 206 - 18 F
INA	PB 1 1/8"
KOYO	SP 102 A
NTN	AELPP 206 - 102 W 3
RHP	LPB 1 1/8 EC
SEALMASTER	SSP - 18 E
SKF	S 1 - 1/8 FM

Group No. PB 0070 - 2

SLB	SBPP 206 - 18
ASAHI	BPP 6 - 18
FYH	SBPP 206 - 18 F
NACHI	BPP 6 - 18
NTN	ASP 206 - 102
SEALMASTER	SSP - 18

Figure MU 02

*Standard Duty Pillow Blocks - Cast Housing
Eccentric Locking Collar Type, Set Screws Type*

1.1250 in	ID	28.58 mm
1.5630 in	SB	39.70 mm
4.7638 in	BC fix	121.00 mm
4.4882 in	BC min	114.00 mm
5.0394 in	BC max	128.00 mm

Group No. PB 0071 - 1

SLB	UCAK 206 - 18
ASAHI	UCLP 206 - 18
BROWNING	VPLS - 218
FYH	SL 206 - 18
INA	RAKY 1 1/8"
LINK - BELT	PL 3 - U 218 N
NACHI	UCLP 206 - 18
NTN	UCPL 206 - 102 D 1
RHP	SL 1 1/8
SEALMASTER	NPL - 18
SKF	SYH 1 - 1/8 TM

Group No. PB 0071 - 2

SLB	UELAK 206 - 18
BROWNING	VPLE - 218
FAFNIR	RAK - 1 - 1/8
INA	RAK 1 1/8"
LINK - BELT	PL 3 - Y 218 N
NTN	UELPL 206 - 102 D 1 W 3
RHP	SL 1 1/8 DEC
SKF	SYH 1 - 1/8 WM

Group No. PB 0071 - 3

SLB	SAAK 206 - 18
BROWNING	VPLE - 118
FAFNIR	VAK - 1 - 1/8

INA	PAK 1 1/8"
LINK - BELT	PL 3 - W 218 E
NTN	AELPL 206 - 102 W 3
RHP	SL 1 1/8 EC
SKF	SYH 1 - 1/8 FM

Group No. PB 0071 - 4

SLB	SBAK 206 - 18
BROWNING	VPLS - 118
LINK - BELT	PL 3 - S 218 E
NTN	ASPL 206 - 102

Figure MU 03

Standard Duty Pillow Blocks - Cast Housing
Eccentric Locking Collar Type, Set Screws Type



1.1250 in	ID	28.58 mm
1.6890 in	SB	42.90 mm
4.7638 in	BC fix	121.00 mm
4.4882 in	BC min	114.00 mm
5.0394 in	BC max	128.00 mm

Group No. PB 0072 - 1

SLB	UCP 206 - 18
ASAHI	UCP 206 - 18
BROWNING	VPS - 218
FAFNIR	RASC - 1 - 1/8
FAG	SG 56206.102
FYH	UCP 206 - 18
INA	RASEY 1 1/8"
KOYO	UCP 206 - 18
LINK - BELT	P 3 - U 218 N
NACHI	UCP 206 - 18
NSK	UCP 206 - 18 S
NTN	UCP 206 - 102 D 1
RHP	NP 1 1/8
SEALMASTER	NP - 18
SKF	SY 1 - 1/8 TM

Group No. PB 0072 - 2

SLB	UELP 206 - 18
BROWNING	VPE - 218
FAFNIR	RAS - 1 - 1/8
FAG	SG 36206 B
FYH	NAP 206 - 18
INA	RASE 1 1/8"
KOYO	GAP 1102 B
LINK - BELT	P 3 - Y 218 N
NACHI	UGP 206 - 18 + ER
NTN	UELP 206 - 102 D 1 W 3
RHP	NP 1 1/8 DEC
SKF	SY 1 - 1/8 WM

Group No. PB 0072 - 3

SLB	SAP 206 - 18
BROWNING	VPE - 118
FAFNIR	VAS - 1 - 1/8

FAG	SG 16206.102
INA	PASE 1 1/8"
KOYO	GARAP 102 A
LINK - BELT	P 3 - W 218 E
RHP	NP 1 1/8 EC
SKF	SY 1 - 1/8 FM

Group No. PB 0072 - 4

SLB	SBP 206 - 18
ASAHI	BP 206 - 18
BROWNING	VPS - 118
FAFNIR	SAS - 1 - 1/8
LINK - BELT	P 3 - S 218 E
NACHI	BP 206 - 18

Figure MU 04

Standard Duty Pillow Blocks - Cast Housing
Set Screws Type



1.1250 in	ID	28.58 mm
1.6890 in	SB	42.90 mm
2.5984 in	BC fix	66.00 mm

Group No. PB 0073 - 1

SLB	UCPA 206 - 18
ASAHI	UCPA 206 - 18
BROWNING	VTBS - 218
FYH	UCPA 206 - 18
INA	RSHEY 1 1/8"
LINK - BELT	PT 3 - U 218 N
NACHI	UCPA 206 - 18
NSK	UCPA 206 - 18 S
NTN	UCUP 206 - 102 D 1
RHP	SNP 1 1/8
SEALMASTER	TB - 18
SKF	SYF 1 - 1/8 TM

Figure MU 07

Medium Duty Pillow Blocks - Cast Housing
Set Screws Type



1.1250 in	ID	28.58 mm
1.8740 in	SB	47.60 mm
5.0000 in	BC fix	127.00 mm
4.7638 in	BC min	121.00 mm
5.2362 in	BC max	133.00 mm

Group No. PB 0074 - 1

SLB	UCP X06 - 18
ASAHI	UCP X06 - 18
NTN	UCP X06 - 102 D 1

Figure MU 08

Heavy Duty Pillow Blocks - Cast Housing
Set Screws Type



1.1250 in	ID	28.58 mm
1.9685 in	SB	50.00 mm
5.5118 in	BC fix	140.00 mm
5.2756 in	BC min	134.00 mm
5.7480 in	BC max	146.00 mm

Group No. PB 0075 - 1

SLB	UCP 306 - 18
ASAHI	UCP 306 - 18
FYH	UCP 306 - 18
NSK	UCP 306 - 18 S
NTN	UCP 306 - 102 D 1

Figure MU 01

Standard Duty Pillow Blocks - Pressed Steel Housing
Eccentric Locking Collar Type, Set Screws Type



1.1811 in	ID	30.00 mm
1.3110 in	SB	33.30 mm
3.7402 in	BC fix	95.00 mm

Group No. PB 0076 - 1

SLB	SAPP 206
FAFNIR	PB - 30
FAG	SB 16206
FYH	SAPP 206 F
INA	PB 30
KOYO	SP 103 MA
NSK	ENPP 206
NTN	AELPP 206 W 3
RHP	LPB 30 EC
SKF	S 30 FM
SNR	62 MVA + 1230 - 30 ECG

Group No. PB 0076 - 2

SLB	SBPP 206
ASAHI	BPP 6
FYH	SBPP 206 F
INA	PBY 30
KOYO	SP 19 M
NACHI	BPP 6
NSK	UBPP 206
NTN	ASPP 206
RHP	LPB 30 A
SEALMASTER	SSP - 206
SNR	62 MVA + 1230 - 30 G

Figure MU 02

Standard Duty Pillow Blocks - Cast Housing
Eccentric Locking Collar Type, Set Screws Type



1.1811 in	ID	30.00 mm
1.5630 in	SB	39.70 mm
4.7638 in	BC fix	121.00 mm
4.4882 in	BC min	114.00 mm
5.0394 in	BC max	128.00 mm

Group No. PB 0077 - 1	
SLB	UCAK 206
ASAHI	UCLP 206
FYH	SL 206
INA	RAKY 30
LINK - BELT	PL 3 - U 2 M 30 N
NACHI	UCLP 206
NTN	UCPL 206 D 1
RHP	SL 30
SEALMASTER	NPL - 206
SNR	SL 30

Group No. PB 0077 - 2	
SLB	UELAK 206
FAFNIR	RAK - 30
INA	RAK 30
NTN	UELPL 206 D 1 W 3
RHP	SL 30 DEC

Group No. PB 0077 - 3	
SLB	SAAK 206
FAFNIR	VAK - 30
INA	PAK 30
NTN	AELPL 206 W 3
RHP	SL 30 EC
SNR	SL 30 EC

Group No. PB 0077 - 4	
SLB	SBAK 206
NTN	ASPL 206
RHP	SL 30 A

Figure MU 03 

Standard Duty Pillow Blocks - Cast Housing
Eccentric Locking Collar Type, Set Screws Type

1.1811 in	ID	30.00 mm
1.6890 in	SB	42.90 mm
4.7638 in	BC fix	121.00 mm
4.4882 in	BC min	114.00 mm
5.0394 in	BC max	128.00 mm

Group No. PB 0078 - 1	
SLB	UCP 206
ASAHI	UCP 206
FAFNIR	RASC - 30
FAG	SG 56206
FYH	UCP 206
INA	RASEY 30
KOYO	UCP 206
LINK - BELT	P 3 - U 2 M 30 N
NACHI	UCP 206
NSK	UCP 206
NTN	UCP 206 D 1
RHP	NP 30
SEALMASTER	NP - 206
SKF	SY 30 TM
SNR	NP 30

Group No. PB 0078 - 2	
SLB	UEL2P 206
FAFNIR	RAS - 30
FYH	NAP 206
INA	RASE 30
KOYO	GAP 1103 MB
NACHI	UGP 206 + ER
NSK	EWP 206
NTN	UEL2P 206 D 1 W 3
RHP	NP 30 DEC
SKF	SY 30 WM

Group No. PB 0078 - 3	
SLB	SAP 206
FAFNIR	VAS - 30
FAG	SG 16206
INA	PASE 30
KOYO	GARAP 103 MA
RHP	NP 30 EC
SKF	SY 30 FM
SNR	NP 30 EC

Group No. PB 0078 - 4	
SLB	SBP 206
ASAHI	BP 206
FAFNIR	SAS - 30
INA	PASEY 30
KOYO	PBP 19 MJ
NACHI	BP 206
NSK	UBP 206 J
RHP	NP 30 A
SNR	NP 30 A

Figure MU 04 

Standard Duty Pillow Blocks - Cast Housing
Set Screws Type

1.1811 in	ID	30.00 mm
1.6890 in	SB	42.90 mm
2.5984 in	BC fix	66.00 mm

Group No. PB 0079 - 1	
SLB	UCPA 206
ASAHI	UCPA 206
FYH	UCPA 206
NACHI	UCPA 206
NSK	UCPA 206
NTN	UCUP 206 D 1
RHP	SNP 30
SEALMASTER	TB - 206
SKF	SYF 30 TM
SNR	SNP 30

Figure MU 05 

Standard Duty Pillow Blocks - Cast Housing
Adapter Type

1.1811 in	ID	30.00 mm
1.8740 in	SB	47.60 mm
5.0000 in	BC fix	127.00 mm
7.9134 in	BC min	201.00 mm
2.0866 in	BC max	53.00 mm

Group No. PB 0080 - 1	
SLB	UKP 207
ASAHI	UKP 207
FYH	UKP 207
NACHI	UKP 207
NSK	UKP 207
NTN	UKP 207 D 1
RHP	NP 1035 - 30 K

Figure MU 06 

Standard Duty Pillow Blocks - Cast Housing
Adapter Type

1.1811 in	ID	30.00 mm
1.8740 in	SB	47.60 mm
2.5984 in	BC fix	66.00 mm

Group No. PB 0081 - 1	
SLB	UKPA 207
FYH	UKPA 207

Figure MU 07 

Medium Duty Pillow Blocks - Cast Housing
Set Screws Type

1.1811 in	ID	30.00 mm
1.8740 in	SB	47.60 mm
5.0000 in	BC fix	127.00 mm
4.7638 in	BC min	121.00 mm
5.2362 in	BC max	133.00 mm

Group No. PB 0082 - 1	
SLB	UCP X06
ASAHI	UCP X06
FYH	UCP X06
NSK	UCP X06
NTN	UCP X06 D 1
RHP	MP 30
SEALMASTER	MP - 306

Figure MU 08 

Heavy Duty Pillow Blocks - Cast Housing
Set Screws Type

1.1811 in	ID	30.00 mm
1.9685 in	SB	50.00 mm
5.5118 in	BC fix	140.00 mm
5.2756 in	BC min	134.00 mm
5.7480 in	BC max	146.00 mm

Group No. PB 0083 - 1	
SLB	UCP 306
ASAHI	UCP 306
FYH	UCP 306
INA	RSAOY 30
NSK	UCP 306
NTN	UCP 306 D 1

Figure MU 01		
Standard Duty Pillow Blocks - Pressed Steel Housing		
Eccentric Locking Collar Type, Set Screws Type		
1.1875 in	ID	30.16 mm
1.3110 in	SB	33.30 mm
3.7402 in	BC fix	95.00 mm

Group No. PB 0084 - 1	
SLB	SAPP 206 - 19
FAFNIR	PB - 1 - 3/16
FAG	SB 16206.103
FYH	SAPP 206 - 19 F
INA	PB 1 3/16"
KOYO	SP 103 A
NTN	AELPP 206 - 103 W 3
RHP	LPB 1 3/16 EC
SEALMASTER	SSP - 19 E
SKF	S 1 - 3/16 FM

Group No. PB 0084 - 2	
SLB	SBPP 206 - 19
ASAHI	BPP 6 - 19
FYH	SBPP 206 - 19 F
NACHI	BPP 6 - 19
NTN	ASPP 206 - 103
SEALMASTER	SSP - 19

Figure MU 02		
Standard Duty Pillow Blocks - Cast Housing		
Eccentric Locking Collar Type, Set Screws Type		
1.1875 in	ID	30.16 mm
1.5630 in	SB	39.70 mm
4.7638 in	BC fix	121.00 mm
4.4882 in	BC min	114.00 mm
5.0394 in	BC max	128.00 mm

Group No. PB 0085 - 1	
SLB	UCAK 206 - 19
ASAHI	UCLP 206 - 19
BROWNING	VPLS - 219
FYH	SL 206 - 19
LINK - BELT	PL 3 - U 219 N
NACHI	UCLP 206 - 19
NTN	UCPL 206 - 103 D 1
RHP	SL 1 3/16
SEALMASTER	NPL - 19
SKF	SYH 1 - 3/16 TM

Group No. PB 0085 - 2	
SLB	UELAK 206 - 19
BROWNING	VPLE - 219
FAFNIR	RAK - 1 - 3/16
INA	RAK 1 3/16"
LINK - BELT	PL 3 - Y 219 N
NTN	UELPL 206 - 103 D 1 W 3
RHP	SL 1 3/16 DEC
SKF	SYH 1 - 3/16 WM

Group No. PB 0085 - 3	
SLB	SAAK 206 - 19
BROWNING	VPLE - 119
FAFNIR	VAK - 1 - 3/16
INA	PAK 1 3/16"
LINK - BELT	PL 3 - W 219 E
NTN	AELPL 206 - 103 W 3
RHP	SL 1 3/16 EC
SKF	SYH 1 - 3/16 FM

Group No. PB 0085 - 4	
SLB	SBAK 206 - 19
BROWNING	VPLS - 119
LINK - BELT	PL 3 - S 219 E
NTN	ASPL 206 - 103

Figure MU 03		
Standard Duty Pillow Blocks - Cast Housing		
Eccentric Locking Collar Type, Set Screws Type		
1.1875 in	ID	30.16 mm
1.6890 in	SB	42.90 mm
4.7638 in	BC fix	121.00 mm
4.4882 in	BC min	114.00 mm
5.0394 in	BC max	128.00 mm

Group No. PB 0086 - 1	
SLB	UCP 206 - 19
ASAHI	UCP 206 - 19
BROWNING	VPS - 219
FAFNIR	RASC - 1 - 3/16
FAG	SG 56206.103
FYH	UCP 206 - 19
KOYO	UCP 206 - 19
LINK - BELT	P 3 - U 219 N
NACHI	UCP 206 - 19
NTN	UCP 206 - 103 D 1
RHP	NP 1 3/16
SEALMASTER	NP - 19
SKF	SY 1 - 3/16 TM

Group No. PB 0086 - 2	
SLB	UELPL 206 - 19
BROWNING	VPE - 219
FAFNIR	RAS - 1 - 3/16
FYH	NAP 206 - 19
INA	RASE 1 3/16"
KOYO	GAP 1103 B

LINK - BELT	P 3 - Y 219 N
NACHI	UGP 206 - 19 + ER
NTN	UELPL 206 - 103 D 1 W 3
RHP	NP 1 3/16 DEC
SKF	SY 1 - 3/16 WM

Group No. PB 0086 - 3	
SLB	SAP 206 - 19
BROWNING	VPE - 119
FAFNIR	VAS - 1 - 3/16
FAG	SG 16206.103
INA	PASE 1 3/16"
KOYO	GARAP 103 A
LINK - BELT	P 3 - W 219 E
RHP	NP 1 3/16 EC
SKF	SY 1 - 3/16 FM

Group No. PB 0086 - 4	
SLB	SBP 206 - 19
ASAHI	BP 206 - 19
BROWNING	VPS - 119
FAFNIR	SAS - 1 - 3/16
LINK - BELT	P 3 - S 219 E
NACHI	BP 206 - 19

Figure MU 04		
Standard Duty Pillow Blocks - Cast Housing		
Set Screws Type		
1.1875 in	ID	30.16 mm
1.6890 in	SB	42.90 mm
2.5984 in	BC fix	66.00 mm

Group No. PB 0087 - 1	
SLB	UCPA 206 - 19
ASAHI	UCPA 206 - 19
BROWNING	VTBS - 219
FYH	UCPA 206 - 19
LINK - BELT	PT 3 - U 219 N
NACHI	UCPA 206 - 19
NTN	UCUP 206 - 103 D 1
RHP	SNP 1 3/16
SEALMASTER	TB - 19
SKF	SYF 1 - 3/16 TM

Figure MU 07		
Medium Duty Pillow Blocks - Cast Housing		
Set Screws Type		
1.1875 in	ID	30.16 mm
1.8740 in	SB	47.60 mm
5.0000 in	BC fix	127.00 mm
4.7638 in	BC min	121.00 mm
5.2362 in	BC max	133.00 mm

Group No. PB 0088 - 1	
SLB	UCP X06 - 19
ASAHI	UCP X06 - 19

BROWNING	VPS - 319
FYH	UCP X06 - 19
NTN	UCP X06 - 103 D 1
RHP	MP 1 3/16
SEALMASTER	MP - 19

Figure MU 08

Heavy Duty Pillow Blocks - Cast Housing
Set Screws Type



1.1875 in	ID	30.16 mm
1.9685 in	SB	50.00 mm
5.5118 in	BC fix	140.00 mm
5.2756 in	BC min	134.00 mm
5.7480 in	BC max	146.00 mm

Group No. PB 0089 - 1

SLB	UCP 306 - 19
NTN	UCP 306 - 103 D 1

Figure MU 01

Standard Duty Pillow Blocks - Pressed Steel Housing
Eccentric Locking Collar Type, Set Screws Type



1.2500 in	ID	31.75 mm
1.3110 in	SB	33.30 mm
3.7402 in	BC fix	95.00 mm

Group No. PB 0090 - 1

SLB	SAPP 206 - 20
FAFNIR	PB - 1 - 1/4 S
FAG	SB 16206.104
FYH	SAPP 206 - 20 F
INA	PB 1 1/4" - 206
KOYO	SP 103 A - 1
NTN	AELPP 206 - 104 W 3
RHP	LPB 1 1/4 EC
SEALMASTER	SSP - 20 RE
SKF	S 1 - 1/4 AFM

Group No. PB 0090 - 2

SLB	SBPP 206 - 20
NTN	ASPP 206 - 104
RHP	LPB 1 1/4 A
SEALMASTER	SSP - 20 R

Figure MU 01

Standard Duty Pillow Blocks - Pressed Steel Housing
Eccentric Locking Collar Type, Set Screws Type



1.2500 in	ID	31.75 mm
1.5630 in	SB	39.70 mm
4.1732 in	BC fix	106.00 mm

Group No. PB 0091 - 1

SLB	SAPP 207 - 20
KOYO	SP 104 A

NTN	AELPP 207 - 104 W 3
RHP	LPB 1 1/4 ECL
SKF	S 1 - 1/4 FM

Group No. PB 0091 - 2

SLB	SBPP 207 - 20
ASAHI	BPP 7 - 20
NACHI	BPP 7 - 20
NTN	ASPP 207 - 104
RHP	LPB 1 1/4 AL

Figure MU 02

Standard Duty Pillow Blocks - Cast Housing
Eccentric Locking Collar Type, Set Screws Type



1.2500 in	ID	31.75 mm
1.5630 in	SB	39.70 mm
4.7638 in	BC fix	121.00 mm
4.4882 in	BC min	114.00 mm
5.0394 in	BC max	128.00 mm

Group No. PB 0092 - 1

SLB	UCAK 206 - 20
BROWNING	VPLS - 220 S
INA	RAKY 1 1/4" - 206
LINK - BELT	PL 3 - U 2 E 20 N
NTN	UCPL 206 - 104 D 1
RHP	SL 1 1/4 R
SEALMASTER	NPL - 20 R
SKF	SYH 1 - 1/4 ATM

Group No. PB 0092 - 2

SLB	UELAK 206 - 20
BROWNING	VPLE - 220 S
INA	RAK 1 1/4" - 206
LINK - BELT	PL 3 - Y 2 E 20 N
NTN	UELPL 206 - 104 D 1 W 3
RHP	SL 1 1/4 DECR

Group No. PB 0092 - 3

SLB	SAAK 206 - 20
BROWNING	VPLE - 120 S
FAFNIR	VAK - 1 - 1/4 S
INA	PAK 1 1/4" - 206
LINK - BELT	PL 3 - W 2 E 20 E
NTN	AELPL 206 - 104 W 3
RHP	SL 1 1/4 ECR
SKF	SYH 1 - 1/4 AFM

Group No. PB 0092 - 4

SLB	SBAK 206 - 20
BROWNING	VPLS - 120 S
LINK - BELT	PL 3 - S 2 E 20 E
NTN	ASPL 206 - 104
RHP	SL 1 1/4 AFM

Figure MU 03

Standard Duty Pillow Blocks - Cast Housing
Eccentric Locking Collar Type, Set Screws Type



1.2500 in	ID	31.75 mm
1.6890 in	SB	42.90 mm
4.7638 in	BC fix	121.00 mm
4.4882 in	BC min	114.00 mm
5.0394 in	BC max	128.00 mm

Group No. PB 0093 - 1

SLB	UCP 206 - 20
BROWNING	VPS - 220 S
FAFNIR	RASC - 1 - 1/4 S
INA	RASEY 1 1/4" - 206
LINK - BELT	P 3 - U 2 E 20 N
NTN	UCP 206 - 104 D 1
RHP	NP 1 1/4 R
SEALMASTER	NP - 20 R
SKF	SY 1 - 1/4 ATM

Group No. PB 0093 - 2

SLB	UELP 206 - 20
BROWNING	VPE - 220 S
FYH	NAP 206 - 20
INA	RASE 1 1/4" - 206
KOYO	GAP 1103 B - 1
LINK - BELT	P 3 - Y 2 E 20 N
NACHI	UGP 206 - 20 + ER
NTN	UELPL 206 - 104 D 1 W 3
RHP	NP 1 1/4 DECR
SKF	SY 1 - 1/4 AWM

Group No. PB 0093 - 3

SLB	SAP 206 - 20
BROWNING	VPE - 120 S
FAFNIR	VAS - 1 - 1/4 S
FAG	SG 16206.104
INA	PASE 1 1/4" - 206
KOYO	GARAP 103 A - 1
LINK - BELT	P 3 - W 2 E 20 E
RHP	NP 1 1/4 ECR
SKF	SY 1 - 1/4 AFM

Group No. PB 0093 - 4

SLB	SBP 206 - 20
BROWNING	VPS - 120 S
FAFNIR	SAS - 1 - 1/4 S
LINK - BELT	P 3 - S 2 E 20 E
RHP	NP 1 1/4 AR

Figure MU 04

Standard Duty Pillow Blocks - Cast Housing
Set Screws Type



1.2500 in	ID	31.75 mm
1.6890 in	SB	42.90 mm
2.5984 in	BC fix	66.00 mm

Group No. PB 0094 - 1

SLB	UCPA 206 - 20
BROWNING	VTBS - 220 S

INA	RSHEY 1 1/4" - 206
LINK - BELT	PT 3 - U 2 E 20 N
NTN	UCUP 206 - 104 D 1
RHP	SNP 1 1/4 R
SEALMASTER	TB - 20 R
SKF	SYF 1 - 1/4 ATM

Figure MU 02

Standard Duty Pillow Blocks - Cast Housing
Eccentric Locking Collar Type, Set Screws Type



1.2500 in	ID	31.75 mm
1.8110 in	SB	46.00 mm
5.0000 in	BC fix	127.00 mm
4.7244 in	BC min	120.00 mm
5.2756 in	BC max	134.00 mm

Group No. PB 0095 - 1

SLB	UCAK 207 - 20
ASAHI	UCLP 207 - 20
BROWNING	VPLS - 220
FYH	SL 207 - 20
INA	RAKY 1 1/4"
LINK - BELT	PL 3 - U 220 N
NACHI	UCLP 207 - 20
NTN	UCPL 207 - 104 D 1
RHP	SL 1 1/4
SEALMASTER	NPL - 20
SKF	SYH 1 - 1/4 TM

Group No. PB 0095 - 2

SLB	UELAK 207 - 20
BROWNING	VPLE - 220
FAFNIR	RAK - 1 - 1/4
INA	RAK 1 1/4"
LINK - BELT	PL 3 - Y 220 N
NTN	UELPL 207 - 104 D 1 W 3
RHP	SL 1 1/4 DEC
SKF	SYH 1 - 1/4 WM

Group No. PB 0095 - 3

SLB	SAAK 207 - 20
FAFNIR	VAK - 1 - 1/4
INA	PAK 1 1/4"
LINK - BELT	PL 3 - W 220 E
NTN	AELPL 207 - 104 W 3
RHP	SL 1 1/4 EC
SKF	SYH 1 - 1/4 FM

Group No. PB 0095 - 4

SLB	SBAK 207 - 20
LINK - BELT	PL 3 - S 220 E
NTN	ASPL 207 - 104
RHP	SL 1 1/4 A

Figure MU 03

Standard Duty Pillow Blocks - Cast Housing
Eccentric Locking Collar Type, Set Screws Type



1.2500 in	ID	31.75 mm
1.8740 in	SB	47.60 mm
5.0000 in	BC fix	127.00 mm
4.7244 in	BC min	120.00 mm
5.2756 in	BC max	134.00 mm

Group No. PB 0096 - 1

SLB	UCP 207 - 20
ASAHI	UCP 207 - 20
BROWNING	VPS - 220
FAFNIR	RASC - 1 - 1/4
FAG	SG 56207.104
FYH	UCP 207 - 20
INA	RASEY 1 1/4"
KOYO	UCP 207 - 20
LINK - BELT	P 3 - U 220 N
NACHI	UCP 207 - 20
NSK	UCP 207 - 20 S
NTN	UCP 207 - 104 D 1
RHP	NP 1 1/4
SEALMASTER	NP - 20
SKF	SY 1 - 1/4 TM

Group No. PB 0096 - 2

SLB	UELPL 207 - 20
BROWNING	VPE - 220
FAFNIR	RAS - 1 - 1/4
FYH	NAP 207 - 20
INA	RASE 1 1/4"
KOYO	GAP 1104 B
LINK - BELT	P 3 - Y 220 N
NACHI	UGP 207 - 20 + ER
NTN	UELPL 207 - 104 D 1 W 3
RHP	NP 1 1/4 DEC
SKF	SY 1 - 1/4 WM

Group No. PB 0096 - 3

SLB	SAP 207 - 20
FAFNIR	VAS - 1 - 1/4
INA	PASE 1 1/4"
KOYO	GARAP 104 A
LINK - BELT	P 3 - W 220 E
RHP	NP 1 1/4 EC
SKF	SY 1 - 1/4 FM

Group No. PB 0096 - 4

SLB	SBP 207 - 20
ASAHI	BP 207 - 20
FAFNIR	SAS - 1 - 1/4
LINK - BELT	P 3 - S 220 E
NACHI	BP 207 - 20
RHP	NP 1 1/4 A

Figure MU 04

Standard Duty Pillow Blocks - Cast Housing
Set Screws Type



1.2500 in	ID	31.75 mm
1.8740 in	SB	47.60 mm
3.1496 in	BC fix	80.00 mm

Group No. PB 0097 - 1

SLB	UCPA 207 - 20
ASAHI	UCPA 207 - 20
BROWNING	VTBS - 220
FYH	UCPA 207 - 20
INA	RSHEY 1 1/4"
LINK - BELT	PT 3 - U 220 N
NACHI	UCPA 207 - 20
NSK	UCPA 207 - 20 S
NTN	UCUP 207 - 104 D 1
RHP	SNP 1 1/4
SEALMASTER	TB - 20
SKF	SYF 1 - 1/4 TM

Figure MU 07

Medium Duty Pillow Blocks - Cast Housing
Set Screws Type



1.2500 in	ID	31.75 mm
1.8740 in	SB	47.60 mm
5.0000 in	BC fix	127.00 mm
4.7638 in	BC min	121.00 mm
5.2362 in	BC max	133.00 mm

Group No. PB 0098 - 1

SLB	UCP X06 - 20
ASAHI	UCP X06 - 20
FYH	UCP X06 - 20
NTN	UCP X06 - 104 D 1
RHP	MP 1 1/4
SEALMASTER	MP - 20

Figure MU 08

Heavy Duty Pillow Blocks - Cast Housing
Set Screws Type



1.2500 in	ID	31.75 mm
1.9685 in	SB	50.00 mm
5.5118 in	BC fix	140.00 mm
5.2756 in	BC min	134.00 mm
5.7480 in	BC max	146.00 mm

Group No. PB 0099 - 1

SLB	UCP 306 - 20
FYH	UCP 306 - 20

Figure MU 07

Medium Duty Pillow Blocks - Cast Housing
Set Screws Type



1.2500 in	ID	31.75 mm
2.1260 in	SB	54.00 mm
5.6693 in	BC fix	144.00 mm
5.4331 in	BC min	138.00 mm
5.9055 in	BC max	150.00 mm

Group No. PB 0100 - 1	
SLB	UCP X07 - 20
FYH	UCP X07 - 20

Figure MU 08		
<i>Heavy Duty Pillow Blocks - Cast Housing</i>		
<i>Set Screws Type</i>		
1.2500 in	ID	31.75 mm
2.2047 in	SB	56.00 mm
6.2992 in	BC fix	160.00 mm
5.8661 in	BC min	149.00 mm
6.7323 in	BC max	171.00 mm

Group No. PB 0101 - 1	
SLB	UCP 307 - 20
ASAHI	UCP 307 - 20
FYH	UCP 307 - 20
NSK	UCP 307 - 20 S
NTN	UCP 307 - 104 D 1

Figure MU 01		
<i>Standard Duty Pillow Blocks - Pressed Steel Housing</i>		
<i>Eccentric Locking Collar Type, Set Screws Type</i>		
1.3125 in	ID	33.34 mm
1.5630 in	SB	39.70 mm
4.1732 in	BC fix	106.00 mm

Group No. PB 0102 - 1	
SLB	SAPP 207 - 21
KOYO	SP 105 A
NTN	AELPP 207 - 105 W 3
SKF	S 1 - 5/16 FM

Group No. PB 0102 - 2	
SLB	SBPP 207 - 21
ASAHI	BPP 7 - 21
NACHI	BPP 7 - 21
NTN	ASPP 207 - 105

Figure MU 02		
<i>Standard Duty Pillow Blocks - Cast Housing</i>		
<i>Eccentric Locking Collar Type, Set Screws Type</i>		
1.3125 in	ID	33.34 mm
1.8110 in	SB	46.00 mm
5.0000 in	BC fix	127.00 mm
4.7244 in	BC min	120.00 mm
5.2756 in	BC max	134.00 mm

Group No. PB 0103 - 1	
SLB	UCAK 207 - 21
ASAHI	UCLP 207 - 21
FYH	SL 207 - 21
NACHI	UCLP 207 - 21

NTN	UCPL 207 - 105 D 1
SEALMASTER	NPL - 21
SKF	SYH 1 - 5/16 TM

Group No. PB 0103 - 2	
SLB	UELAK 207 - 21
FAFNIR	RAK - 1 - 5/16
NTN	UELPL 207 - 105 D 1 W 3
SKF	SYH 1 - 5/16 WM

Group No. PB 0103 - 3	
SLB	SAAK 207 - 21
FAFNIR	VAK - 1 - 5/16
NTN	AELPL 207 - 105 W 3
SKF	SYH 1 - 5/16 FM

Group No. PB 0103 - 4	
SLB	SBAK 207 - 21
NTN	ASPL 207 - 105

Figure MU 03		
<i>Standard Duty Pillow Blocks - Cast Housing</i>		
<i>Eccentric Locking Collar Type, Set Screws Type</i>		
1.3125 in	ID	33.34 mm
1.8740 in	SB	47.60 mm
5.0000 in	BC fix	127.00 mm
4.7244 in	BC min	120.00 mm
5.2756 in	BC max	134.00 mm

Group No. PB 0104 - 1	
SLB	UCP 207 - 21
ASAHI	UCP 207 - 21
FAFNIR	RASC - 1 - 5/16
FYH	UCP 207 - 21
KOYO	UCP 207 - 21
NACHI	UCP 207 - 21
NTN	UCP 207 - 105 D 1
SEALMASTER	NP - 21
SKF	SY 1 - 5/16 TM

Group No. PB 0104 - 2	
SLB	UEL 207 - 21
FAFNIR	RAS - 1 - 5/16
KOYO	GAP 1105 B
NACHI	UGP 207 - 21 + ER
NTN	UEL 207 - 105 D 1 W 3
SKF	SY 1 - 5/16 WM

Group No. PB 0104 - 3	
SLB	SAP 207 - 21
FAFNIR	VAS - 1 - 5/16
KOYO	GARAP 105 A
SKF	SY 1 - 5/16 FM

Group No. PB 0104 - 4	
SLB	SBP 207 - 21
ASAHI	BP 207 - 21
NACHI	BP 207 - 21

Figure MU 04		
<i>Standard Duty Pillow Blocks - Cast Housing</i>		
<i>Set Screws Type</i>		
1.3125 in	ID	33.34 mm
1.8740 in	SB	47.60 mm
3.1496 in	BC fix	80.00 mm

Group No. PB 0105 - 1	
SLB	UCPA 207 - 21
ASAHI	UCPA 207 - 21
FYH	UCPA 207 - 21
NACHI	UCPA 207 - 21
NTN	UCUP 207 - 105 D 1
SEALMASTER	TB - 21

Figure MU 07		
<i>Medium Duty Pillow Blocks - Cast Housing</i>		
<i>Set Screws Type</i>		
1.3125 in	ID	33.34 mm
2.1260 in	SB	54.00 mm
5.6693 in	BC fix	144.00 mm
5.4331 in	BC min	138.00 mm
5.9055 in	BC max	150.00 mm

Group No. PB 0106 - 1	
SLB	UCP X07 - 21
NTN	UCP X07 - 105 D 1

Figure MU 08		
<i>Heavy Duty Pillow Blocks - Cast Housing</i>		
<i>Set Screws Type</i>		
1.3125 in	ID	33.34 mm
2.2047 in	SB	56.00 mm
6.2992 in	BC fix	160.00 mm
5.8661 in	BC min	149.00 mm
6.7323 in	BC max	171.00 mm

Group No. PB 0107 - 1	
SLB	UCP 307 - 21
NTN	UCP 307 - 105 D 1

Figure MU 01		
<i>Standard Duty Pillow Blocks - Pressed Steel Housing</i>		
<i>Eccentric Locking Collar Type, Set Screws Type</i>		
1.3750 in	ID	34.93 mm
1.5630 in	SB	39.70 mm
4.1732 in	BC fix	106.00 mm

Group No. PB 0108 - 1	
SLB	SAPP 207 - 22
FAG	SB 16207.106
KOYO	SP 106 A

NTN	AELPP 207 - 106 W 3
RHP	LPB 1 3/8 EC
SKF	S 1 - 3/8 FM
Group No. PB 0108 - 2	
SLB	SBPP 207 - 22
ASAHI	BPP 7 - 22
NACHI	BPP 7 - 22
NTN	ASPP 207 - 106

Figure MU 02		
<i>Standard Duty Pillow Blocks - Cast Housing</i>		
<i>Eccentric Locking Collar Type, Set Screws Type</i>		
1.3750 in	ID	34.93 mm
1.8110 in	SB	46.00 mm
5.0000 in	BC fix	127.00 mm
4.7244 in	BC min	120.00 mm
5.2756 in	BC max	134.00 mm
Group No. PB 0109 - 1		
SLB	UCAK 207 - 22	
ASAHI	UCLP 207 - 22	
BROWNING	VPLS - 222	
FYH	SL 207 - 22	
INA	RAKY 1 3/8"	
LINK - BELT	PL 3 - U 222 N	
NACHI	UCLP 207 - 22	
NTN	UCPL 207 - 106 D 1	
RHP	SL 1 3/8	
SEALMASTER	NPL - 22	
SKF	SYH 1 - 3/8 TM	

Group No. PB 0109 - 2		
SLB	UELAK 207 - 22	
BROWNING	VPLE - 222	
FAFNIR	RAK - 1 - 3/8	
INA	RAK 1 3/8"	
LINK - BELT	PL 3 - Y 222 N	
NTN	UELPL 207 - 106 D 1 W 3	
RHP	SL 1 3/8 DEC	
SKF	SYH 1 - 3/8 WM	

Group No. PB 0109 - 3		
SLB	SAAK 207 - 22	
BROWNING	VPLE - 122	
FAFNIR	VAK - 1 - 3/8	
INA	PAK 1 3/8"	
LINK - BELT	PL 3 - W 222 E	
NTN	AELPL 207 - 106 W 3	
RHP	SL 1 3/8 EC	
SKF	SYH 1 - 3/8 FM	

Group No. PB 0109 - 4		
SLB	SBAK 207 - 22	
BROWNING	VPLS - 122	
LINK - BELT	PL 3 - S 222 E	
NTN	ASPL 207 - 106	

Figure MU 03		
<i>Standard Duty Pillow Blocks - Cast Housing</i>		
<i>Eccentric Locking Collar Type, Set Screws Type</i>		
1.3750 in	ID	34.93 mm
1.8740 in	SB	47.60 mm
5.0000 in	BC fix	127.00 mm
4.7244 in	BC min	120.00 mm
5.2756 in	BC max	134.00 mm

Group No. PB 0110 - 1		
SLB	UCP 207 - 22	
ASAHI	UCP 207 - 22	
BROWNING	VPS - 222	
FAFNIR	RASC - 1 - 3/8	
FAG	SG 56207.106	
FYH	UCP 207 - 22	
INA	RASEY 1 3/8"	
KOYO	UCP 207 - 22	
LINK - BELT	P 3 - U 222 N	
NACHI	UCP 207 - 22	
NSK	UCP 207 - 22 S	
NTN	UCP 207 - 106 D 1	
RHP	NP 1 3/8	
SEALMASTER	NP - 22	
SKF	SY 1 - 3/8 TM	

Group No. PB 0110 - 2		
SLB	UELPL 207 - 22	
BROWNING	VPE - 222	
FAFNIR	RAS - 1 - 3/8	
FAG	SG 36207 B	
FYH	NAP 207 - 22	
INA	RASE 1 3/8"	
KOYO	GAP 1106 B	
LINK - BELT	P 3 - Y 222 N	
NACHI	UGP 207 - 22 + ER	
NTN	UELPL 207 - 106 D 1 W 3	
RHP	NP 1 3/8 DEC	
SKF	SY 1 - 3/8 WM	

Group No. PB 0110 - 3		
SLB	SAP 207 - 22	
BROWNING	VPE - 122	
FAFNIR	VAS - 1 - 3/8	
FAG	SG 16207.106	
INA	PASE 1 3/8"	
KOYO	GARAP 106 A	
LINK - BELT	P 3 - W 222 E	
RHP	NP 1 3/8 EC	
SKF	SY 1 - 3/8 FM	

Group No. PB 0110 - 4		
SLB	SBP 207 - 22	
ASAHI	BP 207 - 22	
BROWNING	VPS - 122	
FAFNIR	SAS - 1 - 3/8	
LINK - BELT	P 3 - S 222 E	
NACHI	BP 207 - 22	

Figure MU 04		
<i>Standard Duty Pillow Blocks - Cast Housing</i>		
<i>Set Screws Type</i>		
1.3750 in	ID	34.93 mm
1.8740 in	SB	47.60 mm
3.1496 in	BC fix	80.00 mm

Group No. PB 0111 - 1		
SLB	UCPA 207 - 22	
ASAHI	UCPA 207 - 22	
BROWNING	VTBS - 222	
FYH	UCPA 207 - 22	
INA	RSHEY 1 3/8"	
LINK - BELT	PT 3 - U 222 N	
NACHI	UCPA 207 - 22	
NSK	UCPA 207 - 22 S	
NTN	UCUP 207 - 106 D 1	
RHP	SNP 1 3/8	
SEALMASTER	TB - 22	
SKF	SYF 1 - 3/8 TM	

Figure MU 07		
<i>Medium Duty Pillow Blocks - Cast Housing</i>		
<i>Set Screws Type</i>		
1.3750 in	ID	34.93 mm
2.1260 in	SB	54.00 mm
5.6693 in	BC fix	144.00 mm
5.4331 in	BC min	138.00 mm
5.9055 in	BC max	150.00 mm

Group No. PB 0112 - 1		
SLB	UCP X07 - 22	
ASAHI	UCP X07 - 22	
FYH	UCP X07 - 22	
NTN	UCP X07 - 106 D 1	
RHP	MP 1 3/8	

Figure MU 08		
<i>Heavy Duty Pillow Blocks - Cast Housing</i>		
<i>Set Screws Type</i>		
1.3750 in	ID	34.93 mm
2.2047 in	SB	56.00 mm
6.2992 in	BC fix	160.00 mm
5.8661 in	BC min	149.00 mm
6.7323 in	BC max	171.00 mm

Group No. PB 0113 - 1		
SLB	UCP 307 - 22	
ASAHI	UCP 307 - 22	
FYH	UCP 307 - 22	
NTN	UCP 307 - 106 D 1	

Figure MU 01		
<i>Standard Duty Pillow Blocks - Pressed Steel Housing</i>		
<i>Eccentric Locking Collar Type, Set Screws Type</i>		

1.3780 in	ID	35.00 mm
1.5630 in	SB	39.70 mm
4.1732 in	BC fix	106.00 mm

Group No. PB 0114 - 1

SLB	SAPP 207
FAG	SB 16207
KOYO	SP 106 MA
NSK	ENPP 207
NTN	AELPP 207 W 3
RHP	LPB 35 EC
SKF	S 35 FM

Group No. PB 0114 - 2

SLB	SBPP 207
ASAHI	BPP 7
KOYO	SP 22 M
NACHI	BPP 7
NSK	UBPP 207
NTN	ASPP 207
RHP	LPB 35 A

Figure MU 02

*Standard Duty Pillow Blocks - Cast Housing
Eccentric Locking Collar Type, Set Screws Type*

1.3780 in	ID	35.00 mm
1.8110 in	SB	46.00 mm
5.0000 in	BC fix	127.00 mm
4.7244 in	BC min	120.00 mm
5.2756 in	BC max	134.00 mm

Group No. PB 0115 - 1

SLB	UCAK 207
ASAHI	UCLP 207
FYH	SL 207
INA	RAKY 35
LINK - BELT	PL 3 - U 2 M 35 N
NACHI	UCLP 207
NTN	UCPL 207 D 1
RHP	SL 35
SEALMASTER	NPL - 207
SNR	SL 35

Group No. PB 0115 - 2

SLB	UELAK 207
FAFNIR	RAK - 35
INA	RAK 35
NTN	UELPL 207 D 1 W 3
RHP	SL 35 DEC

Group No. PB 0115 - 3

SLB	SAAK 207
FAFNIR	VAK - 35
INA	PAK 35
NTN	AELPL 207 W 3
RHP	SL 35 EC
SNR	SL 35 EC

Group No. PB 0115 - 4

SLB	SBAK 207
NTN	ASPL 207
RHP	SL 35 A

Figure MU 03

*Standard Duty Pillow Blocks - Cast Housing
Eccentric Locking Collar Type, Set Screws Type*

1.3780 in	ID	35.00 mm
1.8740 in	SB	47.60 mm
5.0000 in	BC fix	127.00 mm
4.7244 in	BC min	120.00 mm
5.2756 in	BC max	134.00 mm

Group No. PB 0116 - 1

SLB	UCP 207
ASAHI	UCP 207
FAFNIR	RASC - 35
FAG	SG 56207
FYH	UCP 207
INA	RASEY 35
KOYO	UCP 207
LINK - BELT	P 3 - U 2 M 35 N
NACHI	UCP 207
NSK	UCP 207
NTN	UCP 207 D 1
RHP	NP 35
SEALMASTER	NP - 207
SKF	SY 35 TM
SNR	NP 35

Group No. PB 0116 - 2

SLB	UELPL 207
FAFNIR	RAS - 35
FYH	NAP 207
INA	RASE 35
KOYO	GAP 1106 MB
NACHI	UGP 207 + ER
NSK	EWP 207
NTN	UELPL 207 D 1 W 3
RHP	NP 35 DEC
SKF	SY 35 WM

Group No. PB 0116 - 3

SLB	SAP 207
FAFNIR	VAS - 35
FAG	SG 16207
INA	PASE 35
KOYO	GARAP 106 MA
RHP	NP 35 EC
SKF	SY 35 FM
SNR	NP 35 EC

Group No. PB 0116 - 4

SLB	SBP 207
ASAHI	BP 207
FAFNIR	SAS - 35

INA	PASEY 35
KOYO	PBP 22 MJ
NACHI	BP 207
NSK	UBP 207 J
RHP	NP 35 A
SNR	NP 35 A

Figure MU 04

*Standard Duty Pillow Blocks - Cast Housing
Set Screws Type*

1.3780 in	ID	35.00 mm
1.8740 in	SB	47.60 mm
3.1496 in	BC fix	80.00 mm

Group No. PB 0117 - 1

SLB	UCPA 207
ASAHI	UCPA 207
FYH	UCPA 207
NACHI	UCPA 207
NSK	UCPA 207
NTN	UCUP 207 D 1
RHP	SNP 35
SEALMASTER	TB - 207
SKF	SYF 35 TM
SNR	SNP 35

Figure MU 05

*Standard Duty Pillow Blocks - Cast Housing
Adapter Type*

1.3780 in	ID	35.00 mm
1.9370 in	SB	49.20 mm
5.3937 in	BC fix	137.00 mm
8.5433 in	BC min	217.00 mm
2.2441 in	BC max	57.00 mm

Group No. PB 0118 - 1

SLB	UKP 208
ASAHI	UKP 208
FYH	UKP 208
NACHI	UKP 208
NSK	UKP 208
NTN	UKP 208 D 1
RHP	NP 1040 - 35 K

Figure MU 06

*Standard Duty Pillow Blocks - Cast Housing
Adapter Type*

1.3780 in	ID	35.00 mm
1.9370 in	SB	49.20 mm
3.1496 in	BC fix	80.00 mm

Group No. PB 0119 - 1

SLB	UKPA 208
FYH	UKPA 208

Figure MU 07

Medium Duty Pillow Blocks - Cast Housing
Set Screws Type



1.3780 in	ID	35.00 mm
2.1260 in	SB	54.00 mm
5.6693 in	BC fix	144.00 mm
5.4331 in	BC min	138.00 mm
5.9055 in	BC max	150.00 mm

Group No. PB 0120 - 1

SLB	UCP X07
ASAHI	UCP X07
FYH	UCP X07
NSK	UCP X07
NTN	UCP X07 D 1
RHP	MP 35
SEALMASTER	MP - 307

Figure MU 08

Heavy Duty Pillow Blocks - Cast Housing
Set Screws Type



1.3780 in	ID	35.00 mm
2.2047 in	SB	56.00 mm
6.2992 in	BC fix	160.00 mm
5.8661 in	BC min	149.00 mm
6.7323 in	BC max	171.00 mm

Group No. PB 0121 - 1

SLB	UCP 307
ASAHI	UCP 307
FYH	UCP 307
NSK	UCP 307
NTN	UCP 307 D 1

Figure MU 01

Standard Duty Pillow Blocks - Pressed Steel Housing
Eccentric Locking Collar Type, Set Screws Type



1.4375 in	ID	36.51 mm
1.5630 in	SB	39.70 mm
4.1732 in	BC fix	106.00 mm

Group No. PB 0122 - 1

SLB	SAPP 207 - 23
KOYO	SP 107 A
NTN	AELPP 207 - 107 W 3
RHP	LPB 1 7/16 EC
SKF	S 1 - 7/16 FM

Group No. PB 0122 - 2

SLB	SBPP 207 - 23
ASAHI	BPP 7 - 23
NACHI	BPP 7 - 23
NTN	ASPP 207 - 107

Figure MU 02

Standard Duty Pillow Blocks - Cast Housing
Eccentric Locking Collar Type, Set Screws Type



1.4375 in	ID	36.51 mm
1.8110 in	SB	46.00 mm
5.0000 in	BC fix	127.00 mm
4.7244 in	BC min	120.00 mm
5.2756 in	BC max	134.00 mm

Group No. PB 0123 - 1

SLB	UCAK 207 - 23
ASAHI	UCLP 207 - 23
BROWNING	VPLS - 223
FYH	SL 207 - 23
LINK - BELT	PL 3 - U 223 N
NACHI	UCLP 207 - 23
NTN	UCPL 207 - 107 D 1
RHP	SL 1 7/16
SEALMASTER	NPL - 23
SKF	SYH 1 - 7/16 TM

Group No. PB 0123 - 2

SLB	UELAK 207 - 23
BROWNING	VPLE - 223
FAFNIR	RAK - 1 - 7/16
INA	RAK 1 7/16"
LINK - BELT	PL 3 - Y 223 N
NTN	UELPL 207 - 107 D 1 W 3
RHP	SL 1 7/16 DEC
SKF	SYH 1 - 7/16 WM

Group No. PB 0123 - 3

SLB	SAAK 207 - 23
BROWNING	VPLE - 123
FAFNIR	VAK - 1 - 7/16
INA	PAK 1 7/16"
LINK - BELT	PL 3 - W 223 E
NTN	AELPL 207 - 107 W 3
RHP	SL 1 7/16 EC
SKF	SYH 1 - 7/16 FM

Group No. PB 0123 - 4

SLB	SBAK 207 - 23
BROWNING	VPLS - 123
LINK - BELT	PL 3 - S 223 E
NTN	ASPL 207 - 107

Figure MU 03

Standard Duty Pillow Blocks - Cast Housing
Eccentric Locking Collar Type, Set Screws Type



1.4375 in	ID	36.51 mm
1.8740 in	SB	47.60 mm
5.0000 in	BC fix	127.00 mm
4.7244 in	BC min	120.00 mm
5.2756 in	BC max	134.00 mm

Group No. PB 0124 - 1

SLB	UCP 207 - 23
ASAHI	UCP 207 - 23
BROWNING	VPS - 223
FAFNIR	RASC - 1 - 7/16
FAG	SG 56207.107
FYH	UCP 207 - 23
KOYO	UCP 207 - 23
LINK - BELT	P 3 - U 223 N
NACHI	UCP 207 - 23
NTN	UCP 207 - 107 D 1
RHP	NP 1 7/16
SEALMASTER	NP - 23
SKF	SY 1 - 7/16 TM

Group No. PB 0124 - 2

SLB	UELPL 207 - 23
BROWNING	VPE - 223
FAFNIR	RAS - 1 - 7/16
FYH	NAP 207 - 23
INA	RASE 1 7/16"
KOYO	GAP 1107 B
LINK - BELT	P 3 - Y 223 N
NACHI	UGP 207 - 23 + ER
NTN	UELPL 207 - 107 D 1 W 3
RHP	NP 1 7/16 DEC
SKF	SY 1 - 7/16 WM

Group No. PB 0124 - 3

SLB	SAP 207 - 23
BROWNING	VPE - 123
FAFNIR	VAS - 1 - 7/16
FAG	SG 16208.108
INA	PASE 1 7/16"
KOYO	GARAP 107 A
LINK - BELT	P 3 - W 223 E
RHP	NP 1 7/16 EC
SKF	SY 1 - 7/16 FM

Group No. PB 0124 - 4

SLB	SBP 207 - 23
ASAHI	BP 207 - 23
BROWNING	VPS - 123
FAFNIR	SAS - 1 - 7/16
LINK - BELT	P 3 - S 223 E
NACHI	BP 207 - 23

Figure MU 04

Standard Duty Pillow Blocks - Cast Housing
Set Screws Type



1.4375 in	ID	36.51 mm
1.8740 in	SB	47.60 mm
3.1496 in	BC fix	80.00 mm

Group No. PB 0125 - 1

SLB	UCPA 207 - 23
ASAHI	UCPA 207 - 23

BROWNING	VTBS - 223
FYH	UCPA 207 - 23
LINK - BELT	PT 3 - U 223 N
NACHI	UCPA 207 - 23
NTN	UCUP 207 - 107 D 1
RHP	SNP 1 7/16
SEALMASTER	TB - 23
SKF	SYF 1 - 7/16 TM

Figure MU 07

Medium Duty Pillow Blocks - Cast Housing
Set Screws Type



1.4375 in	ID	36.51 mm
2.1260 in	SB	54.00 mm
5.6693 in	BC fix	144.00 mm
5.4331 in	BC min	138.00 mm
5.9055 in	BC max	150.00 mm

Group No. PB 0126 - 1

SLB	UCP X07 - 23
ASAHI	UCP X07 - 23
BROWNING	VPS - 323
FYH	UCP X07 - 23
NTN	UCP X07 - 107 D 1
RHP	MP 1 7/16
SEALMASTER	MP - 23
SKF	SYM 1 - 7/16 TM

Figure MU 08

Heavy Duty Pillow Blocks - Cast Housing
Set Screws Type



1.4375 in	ID	36.51 mm
2.2047 in	SB	56.00 mm
6.2992 in	BC fix	160.00 mm
5.8661 in	BC min	149.00 mm
6.7323 in	BC max	171.00 mm

Group No. PB 0127 - 1

SLB	UCP 307 - 23
FYH	UCP 307 - 23
NTN	UCP 307 - 107 D 1

Figure MU 02

Standard Duty Pillow Blocks - Cast Housing
Eccentric Locking Collar Type, Set Screws Type



1.5000 in	ID	38.10 mm
1.9370 in	SB	49.20 mm
5.5118 in	BC fix	140.00 mm
5.2362 in	BC min	133.00 mm
5.7874 in	BC max	147.00 mm

Group No. PB 0128 - 1

SLB	
ASAHI	

BROWNING	VPLS - 224
FYH	SL 208 - 24
INA	RAKY 1 1/2"
LINK - BELT	PL 3 - U 224 N
NACHI	UCLP 208 - 24
NTN	UCP 208 - 108 D 1
RHP	SL 1 1/2
SEALMASTER	NPL - 24
SKF	SYH 1 - 1/2 TM

Group No. PB 0128 - 2

SLB	UELAK 208 - 24
BROWNING	VPLE - 224
FAFNIR	RAK - 1 - 1/2
INA	RAK 1 1/2"
LINK - BELT	PL 3 - Y 224 N
NTN	UEL208 - 108 D 1 W 3
RHP	SL 1 1/2 DEC
SKF	SYH 1 - 1/2 WM

Group No. PB 0128 - 3

SLB	SAAK 208 - 24
FAFNIR	VAK - 1 - 1/2
INA	PAK 1 1/2"
LINK - BELT	PL 3 - W 224 E
RHP	SL 1 1/2 EC
SKF	SYH 1 - 1/2 FM

Group No. PB 0128 - 4

SLB	SBAK 208 - 24
LINK - BELT	PL 3 - S 224 E
RHP	SL 1 1/2 A

Figure MU 03

Standard Duty Pillow Blocks - Cast Housing
Eccentric Locking Collar Type, Set Screws Type



1.5000 in	ID	38.10 mm
1.9370 in	SB	49.20 mm
5.3937 in	BC fix	137.00 mm
5.0394 in	BC min	128.00 mm
5.7480 in	BC max	146.00 mm

Group No. PB 0129 - 1

SLB	UCP 208 - 24
ASAHI	UCP 208 - 24
BROWNING	VPS - 224
FAFNIR	RASC - 1 - 1/2
FAG	SG 56208.108
FYH	UCP 208 - 24
INA	RASEY 1 1/2"
KOYO	UCP 208 - 24
LINK - BELT	P 3 - U 224 N
NACHI	UCP 208 - 24
NSK	UCP 208 - 24 S
NTN	UCP 208 - 108 D 1
RHP	NP 1 1/2
SEALMASTER	NP - 24
SKF	SY 1 - 1/2 TM

Group No. PB 0129 - 2

SLB	UEL208 - 24
BROWNING	VPE - 224
FAFNIR	RAS - 1 - 1/2
FYH	NAP 208 - 24
INA	RASE 1 1/2"
KOYO	GAP 1108 B
LINK - BELT	P 3 - Y 224 N
NACHI	UGP 208 - 24 + ER
NTN	UEL208 - 108 D 1 W 3
RHP	NP 1 1/2 DEC
SKF	SY 1 - 1/2 WM

Group No. PB 0129 - 3

SLB	SAP 208 - 24
FAFNIR	VAS - 1 - 1/2
INA	PASE 1 1/2"
KOYO	GARAP 108 A
LINK - BELT	P 3 - W 224 E
RHP	NP 1 1/2 EC
SKF	SY 1 - 1/2 FM

Group No. PB 0129 - 4

SLB	SBP 208 - 24
FAFNIR	SAS - 1 - 1/2
LINK - BELT	P 3 - S 224 E
RHP	NP 1 1/2 A

Figure MU 04

Standard Duty Pillow Blocks - Cast Housing
Set Screws Type



1.5000 in	ID	38.10 mm
1.9370 in	SB	49.20 mm
3.3071 in	BC fix	84.00 mm

Group No. PB 0130 - 1

SLB	UCPA 208 - 24
ASAHI	UCPA 208 - 24
BROWNING	VTBS - 224
FYH	UCPA 208 - 24
INA	RSHEY 1 1/2"
NACHI	UCPA 208 - 24
NSK	UCPA 208 - 24 S
NTN	UCUP 208 - 108 D 1
RHP	SNP 1 1/2
SEALMASTER	TB - 24
SKF	SYF 1 - 1/2 TM

Figure MU 07

Medium Duty Pillow Blocks - Cast Housing
Set Screws Type



1.5000 in	ID	38.10 mm
2.3110 in	SB	58.70 mm
6.1417 in	BC fix	156.00 mm
5.8661 in	BC min	149.00 mm
6.4173 in	BC max	163.00 mm

Group No. PB 0131 - 1		
SLB	UCP X08 - 24	
ASAHI	UCP X08 - 24	
BROWNING	VPS - 324	
FYH	UCP X08 - 24	
INA	RASEY 1 1/2" - MP	
NTN	UCP X08 - 108 D 1	
RHP	MP 1 1/2	
SEALMASTER	MP - 24	
SKF	SYM 1 - 1/2 TM	

Figure MU 08		
<i>Heavy Duty Pillow Blocks - Cast Housing</i>		
<i>Set Screws Type</i>		
1.5000 in	ID	38.10 mm
2.3622 in	SB	60.00 mm
6.6929 in	BC fix	170.00 mm
6.2598 in	BC min	159.00 mm
7.1260 in	BC max	181.00 mm

Group No. PB 0132 - 1		
SLB	UCP 308 - 24	
ASAHI	UCP 308 - 24	
FYH	UCP 308 - 24	
NSK	UCP 308 - 24 S	
NTN	UCP 308 - 108 D 1	

Figure MU 02		
<i>Standard Duty Pillow Blocks - Cast Housing</i>		
<i>Eccentric Locking Collar Type, Set Screws Type</i>		
1.5625 in	ID	39.69 mm
1.9370 in	SB	49.20 mm
5.5118 in	BC fix	140.00 mm
5.2362 in	BC min	133.00 mm
5.7874 in	BC max	147.00 mm

Group No. PB 0133 - 1		
SLB	UCAK 208 - 25	
ASAHI	UCLP 208 - 25	
FYH	SL 208 - 25	
NACHI	UCLP 208 - 25	
NTN	UCP 208 - 109 D 1	
SEALMASTER	NPL - 25	

Group No. PB 0133 - 2		
SLB	UELAK 208 - 25	
FAFNIR	RAK - 1 - 9/16	
NTN	UELPA 208 - 109 D 1 W 3	

Group No. PB 0133 - 3		
SLB	SAAK 208 - 25	
FAFNIR	VAK - 1 - 9/16	

Figure MU 03		
<i>Standard Duty Pillow Blocks - Cast Housing</i>		
<i>Eccentric Locking Collar Type, Set Screws Type</i>		

1.5625 in	ID	39.69 mm
1.9370 in	SB	49.20 mm
5.3937 in	BC fix	137.00 mm
5.0394 in	BC min	128.00 mm
5.7480 in	BC max	146.00 mm

Group No. PB 0134 - 1		
SLB	UCP 208 - 25	
ASAHI	UCP 208 - 25	
FAFNIR	RASC - 1 - 9/16	
FYH	UCP 208 - 25	
KOYO	UCP 208 - 25	
NACHI	UCP 208 - 25	
NTN	UCP 208 - 109 D 1	
SEALMASTER	NP - 25	
SKF	SY 1 - 9/16 TM	

Group No. PB 0134 - 2		
SLB	UELPA 208 - 25	
FAFNIR	RAS - 1 - 9/16	
FAG	SG 36208 B	
KOYO	GAP 1109 B	
NACHI	UGP 208 - 25 + ER	
NTN	UELPA 208 - 109 D 1 W 3	
SKF	SY 1 - 9/16 WM	

Group No. PB 0134 - 3		
SLB	SAP 208 - 25	
FAFNIR	VAS - 1 - 9/16	
FAG	SG 16208	
KOYO	GARAP 109 A	
SKF	SY 1 - 9/16 FM	

Figure MU 04		
<i>Standard Duty Pillow Blocks - Cast Housing</i>		
<i>Set Screws Type</i>		
1.5625 in	ID	39.69 mm
1.9370 in	SB	49.20 mm
3.3071 in	BC fix	84.00 mm

Group No. PB 0135 - 1		
SLB	UCPA 208 - 25	
ASAHI	UCPA 208 - 25	
FYH	UCPA 208 - 25	
NACHI	UCPA 208 - 25	
NTN	UCUP 208 - 109 D 1	
SEALMASTER	TB - 25	

Figure MU 07		
<i>Medium Duty Pillow Blocks - Cast Housing</i>		
<i>Set Screws Type</i>		
1.5625 in	ID	39.69 mm
2.3110 in	SB	58.70 mm
6.1417 in	BC fix	156.00 mm
5.8661 in	BC min	149.00 mm
6.4173 in	BC max	163.00 mm

Group No. PB 0136 - 1		
SLB	UCP X08 - 25	
NTN	UCP X08 - 109 D 1	

Figure MU 08		
<i>Heavy Duty Pillow Blocks - Cast Housing</i>		
<i>Set Screws Type</i>		
1.5625 in	ID	39.69 mm
2.3622 in	SB	60.00 mm
6.6929 in	BC fix	170.00 mm
6.2598 in	BC min	159.00 mm
7.1260 in	BC max	181.00 mm

Group No. PB 0137 - 1		
SLB	UCP 308 - 25	
NTN	UCP 308 - 109 D 1	

Figure MU 02		
<i>Standard Duty Pillow Blocks - Cast Housing</i>		
<i>Eccentric Locking Collar Type, Set Screws Type</i>		
1.5748 in	ID	40.00 mm
1.9370 in	SB	49.20 mm
5.5118 in	BC fix	140.00 mm
5.2362 in	BC min	133.00 mm
5.7874 in	BC max	147.00 mm

Group No. PB 0138 - 1		
SLB	UCAK 208	
ASAHI	UCLP 208	
FYH	SL 208	
INA	RAKY 40	
LINK - BELT	PL 3 - U 2 M 40 N	
NACHI	UCLP 208	
NTN	UCP 208 D 1	
RHP	SL 40	
SEALMASTER	NPL - 208	
SNR	SL 40	

Group No. PB 0138 - 2		
SLB	UELAK 208	
FAFNIR	RAK - 40	
INA	RAK 40	
NTN	UELPA 208 D 1 W 3	
RHP	SL 40 DEC	

Group No. PB 0138 - 3		
SLB	SAAK 208	
FAFNIR	VAK - 40	
INA	PAK 40	
RHP	SL 40 EC	
SNR	SL 40 EC	

Group No. PB 0138 - 4		
SLB	SBAK 208	
RHP	SL 40 A	

Figure MU 03

Standard Duty Pillow Blocks - Cast Housing
Eccentric Locking Collar Type, Set Screws Type



1.5748 in	ID	40.00 mm
1.9370 in	SB	49.20 mm
5.3937 in	BC fix	137.00 mm
5.0394 in	BC min	128.00 mm
5.7480 in	BC max	146.00 mm

Group No. PB 0139 - 1

SLB	UCP 208
ASAHI	UCP 208
FAFNIR	RASC - 40
FAG	SG 56208
FYH	UCP 208
INA	RASEY 40
KOYO	UCP 208
LINK - BELT	P 3 - U 2 M 40 N
NACHI	UCP 208
NSK	UCP 208
NTN	UCP 208 D 1
RHP	NP 40
SEALMASTER	NP - 208
SKF	SY 40 TM
SNR	NP 40

Group No. PB 0139 - 2

SLB	UELP 208
FAFNIR	RAS - 40
FYH	NAP 208
INA	RASE 40
KOYO	GAP 1109 MB
NACHI	UGP 208 + ER
NSK	EWP 208
NTN	UELP 208 D 1 W 3
RHP	NP 40 DEC
SKF	SY 40 WM

Group No. PB 0139 - 3

SLB	SAP 208
FAFNIR	VAS - 40
INA	PASE 40
KOYO	GARAP 109 MA
RHP	NP 40 EC
SKF	SY 40 FM
SNR	NP 40 EC

Group No. PB 0139 - 4

SLB	SBP 208
FAFNIR	SAS - 40
INA	PASEY 40
KOYO	PBP 25 MJ
RHP	NP 40 A
SNR	NP 40 A

Figure MU 04

Standard Duty Pillow Blocks - Cast Housing
Set Screws Type



1.5748 in	ID	40.00 mm
1.9370 in	SB	49.20 mm
3.3071 in	BC fix	84.00 mm

Group No. PB 0140 - 1

SLB	UCPA 208
ASAHI	UCPA 208
FYH	UCPA 208
NACHI	UCPA 208
NSK	UCPA 208
NTN	UCUP 208 D 1
RHP	SNP 40
SEALMASTER	TB - 208
SKF	SYF 40 TM
SNR	SNP 40

Figure MU 05

Standard Duty Pillow Blocks - Cast Housing
Adapter Type



1.5748 in	ID	40.00 mm
2.1260 in	SB	54.00 mm
5.7480 in	BC fix	146.00 mm
9.1339 in	BC min	232.00 mm
2.3622 in	BC max	60.00 mm

Group No. PB 0141 - 1

SLB	UKP 209
ASAHI	UKP 209
FYH	UKP 209
NACHI	UKP 209
NSK	UKP 209
NTN	UKP 209 D 1
RHP	NP 1045 - 40 K

Figure MU 06

Standard Duty Pillow Blocks - Cast Housing
Adapter Type



1.5748 in	ID	40.00 mm
2.1339 in	SB	54.20 mm
3.3071 in	BC fix	84.00 mm

Group No. PB 0142 - 1

SLB	UKPA 209
FYH	UKPA 209

Figure MU 07

Medium Duty Pillow Blocks - Cast Housing
Set Screws Type



1.5748 in	ID	40.00 mm
2.3110 in	SB	58.70 mm
6.1417 in	BC fix	156.00 mm
5.8661 in	BC min	149.00 mm
6.4173 in	BC max	163.00 mm

Group No. PB 0143 - 1

SLB	UCP X08
ASAHI	UCP X08
FYH	UCP X08
INA	RASEY 40 - MP
NSK	UCP X08
NTN	UCP X08 D 1
RHP	MP 40
SEALMASTER	MP - 308

Figure MU 08

Heavy Duty Pillow Blocks - Cast Housing
Set Screws Type



1.5748 in	ID	40.00 mm
2.3622 in	SB	60.00 mm
6.6929 in	BC fix	170.00 mm
6.2598 in	BC min	159.00 mm
7.1260 in	BC max	181.00 mm

Group No. PB 0144 - 1

SLB	UCP 308
ASAHI	UCP 308
FYH	UCP 308
INA	RSOY 40
NSK	UCP 308
NTN	UCP 308 D 1

Figure MU 02

Standard Duty Pillow Blocks - Cast Housing
Eccentric Locking Collar Type, Set Screws Type



1.6250 in	ID	41.28 mm
2.0630 in	SB	52.40 mm
5.7480 in	BC fix	146.00 mm
5.4724 in	BC min	139.00 mm
6.0236 in	BC max	153.00 mm

Group No. PB 0145 - 1

SLB	UCAK 209 - 26
ASAHI	UCLP 209 - 26
BROWNING	VPLS - 226
FYH	SL 209 - 26
LINK - BELT	PL 3 - U 226 N
NACHI	UCLP 209 - 26
NTN	UCPL 209 - 110 D 1
RHP	SL 1 5/8
SEALMASTER	NPL - 26
SKF	SYH 1 - 5/8 TM

Group No. PB 0145 - 2

SLB	UELAK 209 - 26
BROWNING	VPLE - 226
FAFNIR	RAK - 1 - 5/8
INA	RAK 1 5/8"
LINK - BELT	PL 3 - Y 226 N

NTN	UELPL 209 - 110 D 1 W 3
RHP	SL 1 5/8 DEC
SKF	SYH 1 - 5/8 WM
Group No. PB 0145 - 3	
SLB	SAAK 209 - 26
FAFNIR	VAK - 1 - 5/8
LINK - BELT	PL 3 - W 226 U
RHP	SL 1 5/8 EC
SKF	SYH 1 - 5/8 FM

Figure MU 03 

*Standard Duty Pillow Blocks - Cast Housing
Eccentric Locking Collar Type, Set Screws Type*

1.6250 in	ID	41.28 mm
2.1260 in	SB	54.00 mm
5.7480 in	BC fix	146.00 mm
5.3937 in	BC min	137.00 mm
6.1024 in	BC max	155.00 mm

Group No. PB 0146 - 1

SLB	UCP 209 - 26
ASAHI	UCP 209 - 26
BROWNING	VPS - 226
FAFNIR	RASC - 1 - 5/8
FYH	UCP 209 - 26
KOYO	UCP 209 - 26
LINK - BELT	P 3 - U 226 N
NACHI	UCP 209 - 26
NSK	UCP 209 - 26 S
NTN	UCP 209 - 110 D 1
RHP	NP 1 5/8
SEALMASTER	NP - 26
SKF	SY 1 - 5/8 TM

Group No. PB 0146 - 2

SLB	UELPL 209 - 26
BROWNING	VPE - 226
FAFNIR	RAS - 1 - 5/8
FYH	NAP 209 - 26
INA	RASE 1 5/8"
KOYO	GAP 1110 B
LINK - BELT	P 3 - Y 226 N
NACHI	UGP 209 - 26 + ER
NTN	UELPL 209 - 110 D 1 W 3
RHP	NP 1 5/8 DEC
SKF	SY 1 - 5/8 WM

Group No. PB 0146 - 3

SLB	SAP 209 - 26
FAFNIR	VAS - 1 - 5/8
KOYO	GARAP 110 A
LINK - BELT	P 3 - W 226 U
RHP	NP 1 5/8 EC
SKF	SY 1 - 5/8 FM

Figure MU 04 

*Standard Duty Pillow Blocks - Cast Housing
Set Screws Type*

1.6250 in	ID	41.28 mm
2.1339 in	SB	54.20 mm
3.5433 in	BC fix	90.00 mm

Group No. PB 0147 - 1

SLB	UCPA 209 - 26
ASAHI	UCPA 209 - 26
BROWNING	VTBS - 226
FYH	UCPA 209 - 26
NACHI	UCPA 209 - 26
NSK	UCPA 209 - 26 S
NTN	UCUP 209 - 110 D 1
RHP	SNP 1 5/8
SEALMASTER	TB - 26
SKF	SYF 1 - 5/8 TM

Figure MU 07 

*Medium Duty Pillow Blocks - Cast Housing
Set Screws Type*

1.6250 in	ID	41.28 mm
2.3110 in	SB	58.70 mm
6.1417 in	BC fix	156.00 mm
5.8661 in	BC min	149.00 mm
6.4173 in	BC max	163.00 mm

Group No. PB 0148 - 1

SLB	UCP X09 - 26
ASAHI	UCP X09 - 26
NTN	UCP X09 - 110 D 1

Figure MU 08 

*Heavy Duty Pillow Blocks - Cast Housing
Set Screws Type*

1.6250 in	ID	41.28 mm
2.6378 in	SB	67.00 mm
7.4803 in	BC fix	190.00 mm
7.0866 in	BC min	180.00 mm
7.8740 in	BC max	200.00 mm

Group No. PB 0149 - 1

SLB	UCP 309 - 26
ASAHI	UCP 309 - 26
NSK	UCP 309 - 26 S
NTN	UCP 309 - 110 D 1

Figure MU 02 

*Standard Duty Pillow Blocks - Cast Housing
Eccentric Locking Collar Type, Set Screws Type*

1.6875 in	ID	42.86 mm
2.0630 in	SB	52.40 mm
5.7480 in	BC fix	146.00 mm
5.4724 in	BC min	139.00 mm
6.0236 in	BC max	153.00 mm

Group No. PB 0150 - 1

SLB	UCAK 209 - 27
ASAHI	UCLP 209 - 27
BROWNING	VPLS - 227
FYH	SL 209 - 27
LINK - BELT	PL 3 - U 227 N
NACHI	UCLP 209 - 27
NTN	UCPL 209 - 111 D 1
RHP	SL 1 11/16
SEALMASTER	NPL - 27
SKF	SYH 1 - 11/16 TM

Group No. PB 0150 - 2

SLB	UELAK 209 - 27
BROWNING	VPLE - 227
FAFNIR	RAK - 1 - 11/16
INA	RAK 1 11/16"
LINK - BELT	PL 3 - Y 227 N
NTN	UELPL 209 - 111 D 1 W 3
RHP	SL 1 11/16 DEC
SKF	SYH 1 - 11/16 WM

Group No. PB 0150 - 3

SLB	SAAK 209 - 27
FAFNIR	VAK - 1 - 11/16
LINK - BELT	PL 3 - W 227 U
RHP	SL 1 11/16 EC
SKF	SYH 1 - 11/16 FM

Figure MU 03 

*Standard Duty Pillow Blocks - Cast Housing
Eccentric Locking Collar Type, Set Screws Type*

1.6875 in	ID	42.86 mm
2.1260 in	SB	54.00 mm
5.7480 in	BC fix	146.00 mm
5.3937 in	BC min	137.00 mm
6.1024 in	BC max	155.00 mm

Group No. PB 0151 - 1

SLB	UCP 209 - 27
ASAHI	UCP 209 - 27
BROWNING	VPS - 227
FAFNIR	RASC - 1 - 11/16
FYH	UCP 209 - 27
KOYO	UCP 209 - 27
LINK - BELT	P 3 - U 227 N
NACHI	UCP 209 - 27
NTN	UCP 209 - 111 D 1
RHP	NP 1 11/16
SEALMASTER	NP - 27
SKF	SY 1 - 11/16 TM

Group No. PB 0151 - 2	
SLB	UEL P 209 - 27
BROWNING	VPE - 227
FAFNIR	RAS - 1 - 11/16
FYH	NAP 209 - 27
INA	RASE 1 11/16"
KOYO	GAP 1111 B
LINK - BELT	P 3 - Y 227 N
NACHI	UGP 209 - 27 + ER
NTN	UEL P 209 - 111 D 1 W 3
RHP	NP 1 11/16 DEC
SKF	SY 1 - 11/16 WM

Group No. PB 0151 - 3	
SLB	SAP 209 - 27
FAFNIR	VAS - 1 - 11/16
FAG	SG 16209.112
KOYO	GARAP 111 A
LINK - BELT	P 3 - W 227 U
RHP	NP 1 11/16 EC
SKF	SY 1 - 11/16 FM

Figure MU 04		
<i>Standard Duty Pillow Blocks - Cast Housing</i>		
<i>Set Screws Type</i>		
1.6875 in	ID	42.86 mm
2.1339 in	SB	54.20 mm
3.5433 in	BC fix	90.00 mm

Group No. PB 0152 - 1	
SLB	UCPA 209 - 27
ASAHI	UCPA 209 - 27
BROWNING	VTBS - 227
FYH	UCPA 209 - 27
NACHI	UCPA 209 - 27
NTN	UCUP 209 - 111 D 1
RHP	SNP 1 11/16
SEALMASTER	TB - 27
SKF	SYF 1 - 11/16 TM

Figure MU 07		
<i>Medium Duty Pillow Blocks - Cast Housing</i>		
<i>Set Screws Type</i>		
1.6875 in	ID	42.86 mm
2.3110 in	SB	58.70 mm
6.1417 in	BC fix	156.00 mm
5.8661 in	BC min	149.00 mm
6.4173 in	BC max	163.00 mm

Group No. PB 0153 - 1	
SLB	UCP X09 - 27
ASAHI	UCP X09 - 27
BROWNING	VPS - 327
FYH	UCP X09 - 27
NTN	UCP X09 - 111 D 1

RHP	MP 1 11/16
SEALMASTER	MP - 27
SKF	SYM 1 - 11/16 TM

Figure MU 08		
<i>Heavy Duty Pillow Blocks - Cast Housing</i>		
<i>Set Screws Type</i>		
1.6875 in	ID	42.86 mm
2.6378 in	SB	67.00 mm
7.4803 in	BC fix	190.00 mm
7.0866 in	BC min	180.00 mm
7.8740 in	BC max	200.00 mm

Group No. PB 0154 - 1	
SLB	UCP 309 - 27
NTN	UCP 309 - 111 D 1

Figure MU 02		
<i>Standard Duty Pillow Blocks - Cast Housing</i>		
<i>Eccentric Locking Collar Type, Set Screws Type</i>		
1.7500 in	ID	44.45 mm
2.0630 in	SB	52.40 mm
5.7480 in	BC fix	146.00 mm
5.4724 in	BC min	139.00 mm
6.0236 in	BC max	153.00 mm

Group No. PB 0155 - 1	
SLB	UCAK 209 - 28
ASAHI	UCLP 209 - 28
BROWNING	VPLS - 228
FYH	SL 209 - 28
INA	RAKY 1 3/4"
LINK - BELT	PL 3 - U 228 N
NACHI	UCLP 209 - 28
NTN	UCPL 209 - 112 D 1
RHP	SL 1 3/4
SEALMASTER	NPL - 28
SKF	SYH 1 - 3/4 TM

Group No. PB 0155 - 2	
SLB	UELAK 209 - 28
BROWNING	VPLE - 228
FAFNIR	RAK - 1 - 3/4
INA	RAK 1 3/4"
LINK - BELT	PL 3 - Y 228 N
NTN	UELPL 209 - 112 D 1 W 3
RHP	SL 1 3/4 DEC
SKF	SYH 1 - 3/4 WM

Group No. PB 0155 - 3	
SLB	SAAK 209 - 28
FAFNIR	VAK - 1 - 3/4
INA	PAK 1 3/4"
LINK - BELT	PL 3 - W 228 U
RHP	SL 1 3/4 EC
SKF	SYH 1 - 3/4 FM

Figure MU 03		
<i>Standard Duty Pillow Blocks - Cast Housing</i>		
<i>Eccentric Locking Collar Type, Set Screws Type</i>		
1.7500 in	ID	44.45 mm
2.1260 in	SB	54.00 mm
5.7480 in	BC fix	146.00 mm
5.3937 in	BC min	137.00 mm
6.1024 in	BC max	155.00 mm

Group No. PB 0156 - 1	
SLB	UCP 209 - 28
ASAHI	UCP 209 - 28
BROWNING	VPS - 228
FAFNIR	RASC - 1 - 3/4
FAG	SG 56209.112
FYH	UCP 209 - 28
INA	RASEY 1 3/4"
KOYO	UCP 209 - 28
LINK - BELT	P 3 - U 228 N
NACHI	UCP 209 - 28
NSK	UCP 209 - 28 S
NTN	UCP 209 - 112 D 1
RHP	NP 1 3/4
SEALMASTER	NP - 28
SKF	SY 1 - 3/4 TM

Group No. PB 0156 - 2	
SLB	UEL P 209 - 28
BROWNING	VPE - 228
FAFNIR	RAS - 1 - 3/4
FAG	SG 36209 B
FYH	NAP 209 - 28
INA	RASE 1 3/4"
KOYO	GAP 1112 B
LINK - BELT	P 3 - Y 228 N
NACHI	UGP 209 - 28 + ER
NTN	UEL P 209 - 112 D 1 W 3
RHP	NP 1 3/4 DEC
SKF	SY 1 - 3/4 WM

Group No. PB 0156 - 3	
SLB	SAP 209 - 28
FAFNIR	VAS - 1 - 3/4
FAG	SG 16209
INA	PASE 1 3/4"
KOYO	GARAP 112 A
LINK - BELT	P 3 - W 228 U
RHP	NP 1 3/4 EC
SKF	SY 1 - 3/4 FM

Figure MU 04		
<i>Standard Duty Pillow Blocks - Cast Housing</i>		
<i>Set Screws Type</i>		
1.7500 in	ID	44.45 mm
2.1339 in	SB	54.20 mm
3.5433 in	BC fix	90.00 mm

Group No. PB 0157 - 1	
SLB	UCPA 209 - 28
ASAHI	UCPA 209 - 28
BROWNING	VTBS - 228
FYH	UCPA 209 - 28
INA	RSHEY 1 3/4"
NACHI	UCPA 209 - 28
NSK	UCPA 209 - 28 S
NTN	UCUP 209 - 112 D 1
RHP	SNP 1 3/4
SEALMASTER	TB - 28
SKF	SYF 1 - 3/4 TM

Figure MU 07	
<i>Medium Duty Pillow Blocks - Cast Housing</i>	
<i>Set Screws Type</i>	
1.7500 in	ID 44.45 mm
2.3110 in	SB 58.70 mm
6.1417 in	BC fix 156.00 mm
5.8661 in	BC min 149.00 mm
6.4173 in	BC max 163.00 mm

Group No. PB 0158 - 1	
SLB	UCP X09 - 28
ASAHI	UCP X09 - 28
BROWNING	VPS - 328
FYH	UCP X09 - 28
INA	RASEY 1 3/4" - MP
NTN	UCP X09 - 112 D 1
RHP	MP 1 3/4
SEALMASTER	MP - 28
SKF	SYM 1 - 3/4 TM

Figure MU 08	
<i>Heavy Duty Pillow Blocks - Cast Housing</i>	
<i>Set Screws Type</i>	
1.7500 in	ID 44.45 mm
2.6378 in	SB 67.00 mm
7.4803 in	BC fix 190.00 mm
7.0866 in	BC min 180.00 mm
7.8740 in	BC max 200.00 mm

Group No. PB 0159 - 1	
SLB	UCP 309 - 28
ASAHI	UCP 309 - 28
FYH	UCP 309 - 28
NSK	UCP 309 - 28 S
NTN	UCP 309 - 112 D 1

Figure MU 02	
<i>Standard Duty Pillow Blocks - Cast Housing</i>	
<i>Eccentric Locking Collar Type, Set Screws Type</i>	

1.7717 in	ID	45.00 mm
2.0630 in	SB	52.40 mm
5.7480 in	BC fix	146.00 mm
5.4724 in	BC min	139.00 mm
6.0236 in	BC max	153.00 mm

Group No. PB 0160 - 1	
SLB	UCAK 209
ASAHI	UCLP 209
FYH	SL 209
INA	RAKY 45
LINK - BELT	PL 3 - U 2 M 45 N
NACHI	UCLP 209
NTN	UCPL 209 D 1
RHP	SL 45
SEALMASTER	NPL - 209
SNR	SL 45

Group No. PB 0160 - 2	
SLB	UELAK 209
FAFNIR	RAK - 45
INA	RAK 45
NTN	UELPL 209 D1 W 3
RHP	SL 45 DEC

Group No. PB 0160 - 3	
SLB	SAAK 209
FAFNIR	VAK - 45
INA	PAK 45
RHP	SL 45 EC
SNR	SL 45 EC

Figure MU 03	
<i>Standard Duty Pillow Blocks - Cast Housing</i>	
<i>Eccentric Locking Collar Type, Set Screws Type</i>	

1.7717 in	ID	45.00 mm
2.1260 in	SB	54.00 mm
5.7480 in	BC fix	146.00 mm
5.3937 in	BC min	137.00 mm
6.1024 in	BC max	155.00 mm

Group No. PB 0161 - 1	
SLB	UCP 209
ASAHI	UCP 209
FAFNIR	RASC - 45
FAG	SG 56209
FYH	UCP 209
INA	RASEY 45
KOYO	UCP 209
LINK - BELT	P 3 - U 2 M 45 N
NACHI	UCP 209
NSK	UCP 209
NTN	UCP 209 D 1
RHP	NP 45
SEALMASTER	NP - 209
SKF	SY 45 TM

Group No. PB 0161 - 2	
SLB	UEL 209
FAFNIR	RAS - 45
FYH	NAP 209
INA	RASE 45
KOYO	GAP 1112 MB
NACHI	UGP 209 + ER
NSK	EWP 209
NTN	UEL 209 D 1 W 3
RHP	NP 45 DEC
SKF	SY 45 WM

Group No. PB 0161 - 3	
SLB	SAP 209
FAFNIR	VAS - 45
INA	PASE 45
KOYO	GARAP 112 MA
RHP	NP 45 EC
SKF	SY 45 FM
SNR	NP 45 EC

Figure MU 04	
<i>Standard Duty Pillow Blocks - Cast Housing</i>	
<i>Set Screws Type</i>	

1.7717 in	ID	45.00 mm
2.1339 in	SB	54.20 mm
3.5433 in	BC fix	90.00 mm

Group No. PB 0162 - 1	
SLB	UCPA 209
ASAHI	UCPA 209
FYH	UCPA 209
NACHI	UCPA 209
NSK	UCPA 209
NTN	UCUP 209 D 1
RHP	SNP 45
SEALMASTER	TB - 209
SKF	SYF 45 TM

Figure MU 05	
<i>Standard Duty Pillow Blocks - Cast Housing</i>	
<i>Adapter Type</i>	

1.7717 in	ID	45.00 mm
2.2520 in	SB	57.20 mm
6.2598 in	BC fix	159.00 mm
10.1969 in	BC min	259.00 mm
2.3228 in	BC max	59.00 mm

Group No. PB 0163 - 1	
SLB	UKP 210
ASAHI	UKP 210
FYH	UKP 210
NACHI	UKP 210
NSK	UKP 210
NTN	UKP 210 D 1
RHP	NP 1050 - 45 K

Figure MU 06

Standard Duty Pillow Blocks - Cast Housing
Adapter Type



1.7717 in	ID	45.00 mm
2.2520 in	SB	57.20 mm
3.5433 in	BC fix	90.00 mm

Group No. PB 0164 - 1

SLB	UKPA 210
FYH	UKPA 210

Figure MU 07

Medium Duty Pillow Blocks - Cast Housing
Set Screws Type



1.7717 in	ID	45.00 mm
2.3110 in	SB	58.70 mm
6.1417 in	BC fix	156.00 mm
5.8661 in	BC min	149.00 mm
6.4173 in	BC max	163.00 mm

Group No. PB 0165 - 1

SLB	UCP X09
ASAHI	UCP X09
FYH	UCP X09
INA	RASEY 45 - MP
NSK	UCP X09
NTN	UCP X09 D 1
RHP	MP 45
SEALMASTER	MP - 309

Figure MU 08

Heavy Duty Pillow Blocks - Cast Housing
Set Screws Type



1.7717 in	ID	45.00 mm
2.6378 in	SB	67.00 mm
7.4803 in	BC fix	190.00 mm
7.0866 in	BC min	180.00 mm
7.8740 in	BC max	200.00 mm

Group No. PB 0166 - 1

SLB	UCP 309
ASAHI	UCP 309
FYH	UCP 309
NSK	UCP 309
NTN	UCP 309 D 1

Figure MU 02

Standard Duty Pillow Blocks - Cast Housing
Eccentric Locking Collar Type, Set Screws Type



1.8125 in	ID	46.04 mm
2.1890 in	SB	55.60 mm
6.2598 in	BC fix	159.00 mm
6.0630 in	BC min	154.00 mm
6.4567 in	BC max	164.00 mm

Group No. PB 0167 - 1

SLB	UCAK 210 - 29
NTN	UCPL 210 - 113 D 1
SEALMASTER	NPL - 29

Group No. PB 0167 - 2

SLB	UELAK 210 - 29
FAFNIR	RAK - 1 - 13/16
NTN	UELPL 210 - 113 D 1 W 3

Group No. PB 0167 - 3

SLB	SAAK 210 - 29
FAFNIR	VAK - 1 - 13/16

Figure MU 03

Standard Duty Pillow Blocks - Cast Housing
Eccentric Locking Collar Type, Set Screws Type



1.8125 in	ID	46.04 mm
2.2520 in	SB	57.20 mm
6.2598 in	BC fix	159.00 mm
6.0236 in	BC min	153.00 mm
6.4961 in	BC max	165.00 mm

Group No. PB 0168 - 1

SLB	UCP 210 - 29
FAFNIR	RASC - 1 - 13/16
NTN	UCP 210 - 113 D 1
SEALMASTER	NP - 29

Group No. PB 0168 - 2

SLB	UELP 210 - 29
FAFNIR	RAS - 1 - 13/16
NTN	UELP 210 - 113 D 1 W 3

Group No. PB 0168 - 3

SLB	SAP 210 - 29
FAFNIR	VAS - 1 - 13/16

Figure MU 04

Standard Duty Pillow Blocks - Cast Housing
Set Screws Type



1.8125 in	ID	46.04 mm
2.2520 in	SB	57.20 mm
3.7008 in	BC fix	94.00 mm

Group No. PB 0169 - 1

SLB	UCPA 210 - 29
NTN	UCUP 210 - 113 D 1
SEALMASTER	TB - 29

Figure MU 07

Medium Duty Pillow Blocks - Cast Housing
Set Screws Type



1.8125 in	ID	46.04 mm
2.5000 in	SB	63.50 mm
6.7323 in	BC fix	171.00 mm
6.4567 in	BC min	164.00 mm
7.0079 in	BC max	178.00 mm

Group No. PB 0170 - 1

SLB	UCP X10 - 29
FYH	UCP X10 - 29

Figure MU 08

Heavy Duty Pillow Blocks - Cast Housing
Set Screws Type



1.8125 in	ID	46.04 mm
2.9528 in	SB	75.00 mm
8.3465 in	BC fix	212.00 mm
7.7953 in	BC min	198.00 mm
8.8976 in	BC max	226.00 mm

Group No. PB 0171 - 1

SLB	UCP 310 - 29
NTN	UCP 310 - 113 D 1

Figure MU 02

Standard Duty Pillow Blocks - Cast Housing
Eccentric Locking Collar Type, Set Screws Type



1.8750 in	ID	47.63 mm
2.1890 in	SB	55.60 mm
6.2598 in	BC fix	159.00 mm
6.0630 in	BC min	154.00 mm
6.4567 in	BC max	164.00 mm

Group No. PB 0172 - 1

SLB	UCAK 210 - 30
ASAHI	UCLP 210 - 30
FYH	SL 210 - 30
NACHI	UCLP 210 - 30
NTN	UCPL 210 - 114 D 1
RHP	SL 1 7/8
SEALMASTER	NPL - 30

Group No. PB 0172 - 2

SLB	UELAK 210 - 30
FAFNIR	RAK - 1 - 7/8
NTN	UELPL 210 - 114 D 1 W 3
RHP	SL 1 7/8 DEC

Group No. PB 0172 - 3

SLB	SAAK 210 - 30
FAFNIR	VAK - 1 - 7/8
RHP	SL 1 7/8 EC

Figure MU 03

Standard Duty Pillow Blocks - Cast Housing
Eccentric Locking Collar Type, Set Screws Type



1.8750 in	ID	47.63 mm
2.2520 in	SB	57.20 mm
6.2598 in	BC fix	159.00 mm
6.0236 in	BC min	153.00 mm
6.4961 in	BC max	165.00 mm

Group No. PB 0173 - 1

SLB	UCP 210 - 30
ASAHI	UCP 210 - 30
FAFNIR	RASC - 1 - 7/8
FYH	UCP 210 - 30
KOYO	UCP 210 - 30
NACHI	UCP 210 - 30
NSK	UCP 210 - 30 S
NTN	UCP 210 - 114 D 1
RHP	NP 1 7/8
SEALMASTER	NP - 30
SKF	SY 1 - 7/8 TM

Group No. PB 0173 - 2

SLB	UELPL 210 - 30
FAFNIR	RAS - 1 - 7/8
KOYO	GAP 1114 B
NACHI	UGP 210 - 30 + ER
NTN	UELPL 210 - 114 D 1 W 3
RHP	NP 1 7/8 DEC
SKF	SY 1 - 7/8 WM

Group No. PB 0173 - 3

SLB	SAP 210 - 30
FAFNIR	VAS - 1 - 7/8
KOYO	GARAP 114 A
RHP	NP 1 7/8 EC
SKF	SY 1 - 7/8 FM

Figure MU 04

*Standard Duty Pillow Blocks - Cast Housing
Set Screws Type*



1.8750 in	ID	47.63 mm
2.2520 in	SB	57.20 mm
3.7008 in	BC fix	94.00 mm

Group No. PB 0174 - 1

SLB	UCPA 210 - 30
ASAHI	UCPA 210 - 30
FYH	UCPA 210 - 30
NACHI	UCPA 210 - 30
NSK	UCPA 210 - 30 S
NTN	UCUP 210 - 114 D 1
RHP	SNP 1 7/8
SEALMASTER	TB - 30

Figure MU 07

*Medium Duty Pillow Blocks - Cast Housing
Set Screws Type*



1.8750 in	ID	47.63 mm
2.5000 in	SB	63.50 mm
6.7323 in	BC fix	171.00 mm
6.4567 in	BC min	164.00 mm
7.0079 in	BC max	178.00 mm

Group No. PB 0175 - 1

SLB	UCP X10 - 30
ASAHI	UCP X10 - 30
NTN	UCP X10 - 114 D 1
RHP	MP 1 7/8

Figure MU 08

*Heavy Duty Pillow Blocks - Cast Housing
Set Screws Type*



1.8750 in	ID	47.63 mm
2.9528 in	SB	75.00 mm
8.3465 in	BC fix	212.00 mm
7.7953 in	BC min	198.00 mm
8.8976 in	BC max	226.00 mm

Group No. PB 0176 - 1

SLB	UCP 310 - 30
ASAHI	UCP 310 - 30
NSK	UCP 310 - 30 S
NTN	UCP 310 - 114 D 1

Figure MU 02

*Standard Duty Pillow Blocks - Cast Housing
Eccentric Locking Collar Type, Set Screws Type*



1.9375 in	ID	49.21 mm
2.1890 in	SB	55.60 mm
6.2598 in	BC fix	159.00 mm
6.0630 in	BC min	154.00 mm
6.4567 in	BC max	164.00 mm

Group No. PB 0177 - 1

SLB	UCAK 210 - 31
ASAHI	UCLP 210 - 31
BROWNING	VPLS - 231
FYH	SL 210 - 31
INA	RAKY 1 15/16"
LINK - BELT	PL 3 - U 231 N
NACHI	UCLP 210 - 31
NTN	UCPL 210 - 115 D 1
RHP	SL 1 15/16
SEALMASTER	NPL - 31
SKF	SYH 1 - 15/16 TM

Group No. PB 0177 - 2

SLB	UELAK 210 - 31
BROWNING	VPLE - 231
FAFNIR	RAK - 1 - 15/16
INA	RAK 1 15/16"
LINK - BELT	PL 3 - Y 231 N

NTN	UELPL 210 - 115 D 1 W 3
RHP	SL 1 15/16 DEC
SKF	SYH 1 - 15/16 WM

Group No. PB 0177 - 3

SLB	SAAK 210 - 31
FAFNIR	VAK - 1 - 15/16
INA	PAK 1 15/16"
LINK - BELT	PL 3 - W 231 U
RHP	SL 1 15/16 EC
SKF	SYH 1 - 15/16 FM

Figure MU 03

*Standard Duty Pillow Blocks - Cast Housing
Eccentric Locking Collar Type, Set Screws Type*



1.9375 in	ID	49.21 mm
2.2520 in	SB	57.20 mm
6.2598 in	BC fix	159.00 mm
6.0236 in	BC min	153.00 mm
6.4961 in	BC max	165.00 mm

Group No. PB 0178 - 1

SLB	UCP 210 - 31
ASAHI	UCP 210 - 31
BROWNING	VPS - 231
FAFNIR	RASC - 1 - 15/16
FAG	SG 56210.115
FYH	UCP 210 - 31
INA	RASEY 1 15/16"
KOYO	UCP 210 - 31
LINK - BELT	P 3 - U 231 N
NACHI	UCP 210 - 31
NTN	UCP 210 - 115 D 1
RHP	NP 1 15/16
SEALMASTER	NP - 31
SKF	SY 1 - 15/16 TM

Group No. PB 0178 - 2

SLB	UELPL 210 - 31
BROWNING	VPE - 231
FAFNIR	RAS - 1 - 15/16
FAG	SG 36210 B
FYH	NAP 210 - 31
INA	RASE 1 15/16"
KOYO	GAP 1115 B
LINK - BELT	P 3 - Y 231 N
NACHI	UGP 210 - 31 + ER
NTN	UELPL 210 - 115 D 1 W 3
RHP	NP 1 15/16 DEC
SKF	SY 1 - 15/16 WM

Group No. PB 0178 - 3

SLB	SAP 210 - 31
FAFNIR	VAS - 1 - 15/16
FAG	SG 16210
INA	PASE 1 15/16"

KOYO	GARAP 115 A
LINK - BELT	P 3 - W 231 U
RHP	NP 1 15/16 EC
SKF	SY 1 - 15/16 FM

Figure MU 04

Standard Duty Pillow Blocks - Cast Housing
Set Screws Type



1.9375 in	ID	49.21 mm
2.2520 in	SB	57.20 mm
3.7008 in	BC fix	94.00 mm

Group No. PB 0179 - 1

SLB	UCPA 210 - 31
ASAHI	UCPA 210 - 31
BROWNING	VTBS - 231
FYH	UCPA 210 - 31
INA	RSHEY 1 15/16"
LINK - BELT	PT 3 - U 231 N
NACHI	UCPA 210 - 31
NTN	UCUP 210 - 115 D 1
RHP	SNP 1 15/16
SEALMASTER	TB - 31
SKF	SYF 1 - 15/16 TM

Figure MU 07

Medium Duty Pillow Blocks - Cast Housing
Set Screws Type



1.9375 in	ID	49.21 mm
2.5000 in	SB	63.50 mm
6.7323 in	BC fix	171.00 mm
6.4567 in	BC min	164.00 mm
7.0079 in	BC max	178.00 mm

Group No. PB 0180 - 1

SLB	UCP X10 - 31
ASAHI	UCP X10 - 31
BROWNING	VPS - 331
FYH	UCP X10 - 31
NTN	UCP X10 - 115 D 1
RHP	MP 1 15/16
SEALMASTER	MP - 31
SKF	SYM 1 - 15/16 TM

Figure MU 08

Heavy Duty Pillow Blocks - Cast Housing
Set Screws Type



1.9375 in	ID	49.21 mm
2.9528 in	SB	75.00 mm
8.3465 in	BC fix	212.00 mm
7.7953 in	BC min	198.00 mm
8.8976 in	BC max	226.00 mm

Group No. PB 0181 - 1

SLB	UCP 310 - 31
FYH	UCP 310 - 31
NTN	UCP 310 - 115 D 1

Figure MU 02

Standard Duty Pillow Blocks - Cast Housing
Eccentric Locking Collar Type, Set Screws Type



1.9685 in	ID	50.00 mm
2.1890 in	SB	55.60 mm
6.2598 in	BC fix	159.00 mm
6.0630 in	BC min	154.00 mm
6.4567 in	BC max	164.00 mm

Group No. PB 0182 - 1

SLB	UCAK 210
ASAHI	UCLP 210
FYH	SL 210
INA	RAKY 50
LINK - BELT	PL 3 - U 2 M 50 N
NACHI	UCLP 210
NTN	UCPL 210 D 1
RHP	SL 50
SEALMASTER	NPL - 210
SNR	SL 50

Group No. PB 0182 - 2

SLB	UELAK 210
FAFNIR	RAK - 50
INA	RAK 50
NTN	UELPL 210 D 1 W 3
RHP	SL 50 DEC

Group No. PB 0182 - 3

SLB	SAAK 210
FAFNIR	VAK - 50
INA	PAK 50
RHP	SL 50 EC
SNR	SL 50 EC

Figure MU 03

Standard Duty Pillow Blocks - Cast Housing
Eccentric Locking Collar Type, Set Screws Type



1.9685 in	ID	50.00 mm
2.2520 in	SB	57.20 mm
6.2598 in	BC fix	159.00 mm
6.0236 in	BC min	153.00 mm
6.4961 in	BC max	165.00 mm

Group No. PB 0183 - 1

SLB	UCP 210
ASAHI	UCP 210
FAFNIR	RASC - 50
FAG	SG 56210

FYH	UCP 210
INA	RASEY 50
KOYO	UCP 210
LINK - BELT	P 3 - U 2 M 50 N
NACHI	UCP 210
NSK	UCP 210
NTN	UCP 210 D 1
RHP	NP 50
SEALMASTER	NP - 210
SKF	SY 50 TM
SNR	NP 50

Group No. PB 0183 - 2

SLB	UELPL 210
FAFNIR	RAS - 50
FYH	NAP 210
INA	RASE 50
KOYO	GAP 1115 MB
NACHI	UGP 210 + ER
NSK	EWP 210
NTN	UELPL 210 D 1 W 3
RHP	NP 50 DEC
SKF	SY 50 WM

Group No. PB 0183 - 3

SLB	SAP 210
FAFNIR	VAS - 50
INA	PASE 50
KOYO	GARAP 115 MA
RHP	NP 50 EC
SKF	SY 50 FM
SNR	NP 50 EC

Figure MU 04

Standard Duty Pillow Blocks - Cast Housing
Set Screws Type



1.9685 in	ID	50.00 mm
2.2520 in	SB	57.20 mm
3.7008 in	BC fix	94.00 mm

Group No. PB 0184 - 1

SLB	UCPA 210
ASAHI	UCPA 210
FYH	UCPA 210
NACHI	UCPA 210
NSK	UCPA 210
NTN	UCUP 210 D 1
RHP	SNP 50
SEALMASTER	TB - 210
SKF	SYF 50 TM
SNR	SNP 50

Figure MU 05

Standard Duty Pillow Blocks - Cast Housing
Adapter Type



1.9685 in	ID	50.00 mm
2.5000 in	SB	63.50 mm
6.7717 in	BC fix	172.00 mm
7.6772 in	BC min	195.00 mm
5.8661 in	BC max	149.00 mm

Group No. PB 0185 - 1

SLB	UKP 211
ASAHI	UKP 211
FYH	UKP 211
NACHI	UKP 211
NSK	UKP 211
NTN	UKP 211 D 1
RHP	NP 1055 - 50 K

Figure MU 06

Standard Duty Pillow Blocks - Cast Housing
Adapter Type

1.9685 in	ID	50.00 mm
2.5000 in	SB	63.50 mm
7.4409 in	BC fix	0189 mm

Group No. PB 0186 - 1

SLB	UKPA 211
FYH	UKPA 211

Figure MU 07

Medium Duty Pillow Blocks - Cast Housing
Set Screws Type

1.9685 in	ID	50.00 mm
2.5000 in	SB	63.50 mm
6.7323 in	BC fix	171.00 mm
6.4567 in	BC min	164.00 mm
7.0079 in	BC max	178.00 mm

Group No. PB 0187 - 1

SLB	UCP X10
ASAHI	UCP X10
FYH	UCP X10
INA	RASEY 50 - MP
NSK	UCP X10
NTN	UCP X10 D 1
RHP	MP 50
SEALMASTER	MP - 310

Figure MU 08

Heavy Duty Pillow Blocks - Cast Housing
Set Screws Type

1.9685 in	ID	50.00 mm
2.9528 in	SB	75.00 mm
8.3465 in	BC fix	212.00 mm
7.7953 in	BC min	198.00 mm
8.8976 in	BC max	226.00 mm

Group No. PB 0188 - 1

SLB	UCP 310
ASAHI	UCP 310
FYH	UCP 310
INA	RSAYO 50
NSK	UCP 310
NTN	UCP 310 D 1

Figure MU 02

Standard Duty Pillow Blocks - Cast Housing
Eccentric Locking Collar Type, Set Screws Type

2.0000 in	ID	50.80 mm
2.1890 in	SB	55.60 mm
6.2598 in	BC fix	159.00 mm
6.0630 in	BC min	154.00 mm
6.4567 in	BC max	164.00 mm

Group No. PB 0189 - 1

SLB	UCAK 210 - 32
LINK - BELT	PL 3 - U 2 E 32 N
NTN	UCPL 210 - 200 D 1
RHP	SL 2 R
SEALMASTER	NPL - 32 R

Group No. PB 0189 - 2

SLB	UELAK 210 - 32
LINK - BELT	PL 3 - Y 2 E 32 N
NTN	UELPL 210 - 200 D 1 W 3

Group No. PB 0189 - 3

SLB	SAAK 210 - 32
FAFNIR	VAK - 2 S
LINK - BELT	PL 3 - W 2 E 32 U

Figure MU 03

Standard Duty Pillow Blocks - Cast Housing
Eccentric Locking Collar Type, Set Screws Type

2.0000 in	ID	50.80 mm
2.2520 in	SB	57.20 mm
6.2598 in	BC fix	159.00 mm
6.0236 in	BC min	153.00 mm
6.4961 in	BC max	165.00 mm

Group No. PB 0190 - 1

SLB	UCP 210 - 32
FAFNIR	RASC - 2 S
NTN	UCP 210 - 200 D 1
RHP	NP 2 R
SEALMASTER	NP - 32 R

Group No. PB 0190 - 2

SLB	UELPL 210 - 32
LINK - BELT	P 3 - Y 2 E 32 N
NTN	UELPL 210 - 200 D 1 W 3

Group No. PB 0190 - 3

SLB	SAP 210 - 32
FAFNIR	VAS - 2 S
LINK - BELT	P 3 - W 2 E 32 U

Figure MU 04

Standard Duty Pillow Blocks - Cast Housing
Set Screws Type

2.0000 in	ID	50.80 mm
2.2520 in	SB	57.20 mm
3.7008 in	BC fix	94.00 mm

Group No. PB 0191 - 1

SLB	UCPA 210 - 32
BROWNING	VTBS - 232 S
LINK - BELT	PT 3 - U 2 E 32 N
NTN	UCUP 210 - 200 D 1
RHP	SNP 2 R
SEALMASTER	TB - 32 R

Figure MU 02

Standard Duty Pillow Blocks - Cast Housing
Eccentric Locking Collar Type, Set Screws Type

2.0000 in	ID	50.80 mm
2.4370 in	SB	61.90 mm
7.1260 in	BC fix	181.00 mm
6.8110 in	BC min	173.00 mm
7.4409 in	BC max	189.00 mm

Group No. PB 0192 - 1

SLB	UCAK 211 - 32
ASAHI	UCPL 211 - 32
BROWNING	VPLS - 232
FYH	SL 211 - 32
INA	RAKY 2"
LINK - BELT	PL 3 - U 232 N
NACHI	UCPL 211 - 32
NTN	UCPL 211 - 200 D 1
RHP	SL 2
SEALMASTER	NPL - 32
SKF	SYH 2 TM

Group No. PB 0192 - 2

SLB	UELAK 211 - 32
BROWNING	VPLE - 232
FAFNIR	RAK - 2
LINK - BELT	PL 3 - Y 232 N
NTN	UELPL 211 - 200 D 1 W 3
RHP	SL 2 DEC
SKF	SYH 2 WM

Group No. PB 0192 - 3

SLB	SAAK 211 - 32
FAFNIR	VAK - 2
INA	PAK 2"
SKF	SYH 2 FM

Figure MU 03

Standard Duty Pillow Blocks - Cast Housing
Eccentric Locking Collar Type, Set Screws Type



2.0000 in	ID	50.80 mm
2.5000 in	SB	63.50 mm
6.7717 in	BC fix	172.00 mm
6.5354 in	BC min	166.00 mm
7.0079 in	BC max	178.00 mm

Group No. PB 0193 - 1

SLB	UCP 211 - 32
ASAHI	UCP 211 - 32
BROWNING	VPS - 232
FAFNIR	RASC - 2
FAG	SG 56211.200
FYH	UCP 211 - 32
INA	RASEY 2"
KOYO	UCP 211 - 32
LINK - BELT	P 3 - U 232 N
NACHI	UCP 211 - 32
NSK	UCP 211 - 32 S
NTN	UCP 211 - 200 D 1
RHP	NP 2
SEALMASTER	NP - 32
SKF	SY 2 TM

Group No. PB 0193 - 2

SLB	UELPL 211 - 32
BROWNING	VPE - 232
FAFNIR	RAS - 2
FYH	NAP 211 - 32
LINK - BELT	P 3 - Y 232 N
NACHI	UGP 211 - 32 + ER
NTN	UELPL 211 - 200 D 1 W 3
RHP	NP 2 DEC
SKF	SY 2 WM

Group No. PB 0193 - 3

SLB	SAP 211 - 32
FAFNIR	VAS - 2
INA	PASE 2"
KOYO	GARAP 200 A
SKF	SY 2 FM

Figure MU 04

Standard Duty Pillow Blocks - Cast Housing
Set Screws Type



2.0000 in	ID	50.80 mm
2.5000 in	SB	63.50 mm
4.0945 in	BC fix	104.00 mm

Group No. PB 0194 - 1

SLB	UCPA 211 - 32
INA	RSHEY 2"
RHP	SNP 2
SKF	SYF 2 TM

Figure MU 07

Medium Duty Pillow Blocks - Cast Housing
Set Screws Type



2.0000 in	ID	50.80 mm
2.5000 in	SB	63.50 mm
6.7323 in	BC fix	171.00 mm
6.4567 in	BC min	164.00 mm
7.0079 in	BC max	178.00 mm

Group No. PB 0195 - 1

SLB	UCP X10 - 32
ASAHI	UCP X10 - 32
BROWNING	VPS - 332
FYH	UCP X10 - 32
INA	RASEY 2" - MP
NTN	UCP X10 - 200 D 1
RHP	MP 2 R
SEALMASTER	MP - 32

Figure MU 07

Medium Duty Pillow Blocks - Cast Housing
Set Screws Type



2.0000 in	ID	50.80 mm
2.7480 in	SB	69.80 mm
7.2441 in	BC fix	184.00 mm
6.9291 in	BC min	176.00 mm
7.5591 in	BC max	192.00 mm

Group No. PB 0196 - 1

SLB	UCP X11 - 32
FYH	UCP X11 - 32

Figure MU 08

Heavy Duty Pillow Blocks - Cast Housing
Set Screws Type



2.0000 in	ID	50.80 mm
2.9528 in	SB	75.00 mm
8.3465 in	BC fix	212.00 mm
7.7953 in	BC min	198.00 mm
8.8976 in	BC max	226.00 mm

Group No. PB 0197 - 1

SLB	UCP 310 - 32
FYH	UCP 310 - 32

Figure MU 08

Heavy Duty Pillow Blocks - Cast Housing
Set Screws Type



2.0000 in	ID	50.80 mm
3.1496 in	SB	80.00 mm
9.2913 in	BC fix	236.00 mm
8.6614 in	BC min	220.00 mm
9.9213 in	BC max	252.00 mm

Group No. PB 0198 - 1

SLB	UCP 311 - 32
ASAHI	UCP 311 - 32
FYH	UCP 311 - 32
NSK	UCP 311 - 32 S
NTN	UCP 311 - 200 D 1

Figure MU 02

Standard Duty Pillow Blocks - Cast Housing
Eccentric Locking Collar Type, Set Screws Type



2.0625 in	ID	52.39 mm
2.4370 in	SB	61.90 mm
7.1260 in	BC fix	181.00 mm
6.8110 in	BC min	173.00 mm
7.4409 in	BC max	189.00 mm

Group No. PB 0199 - 1

SLB	UCAK 211 - 33
NTN	UCPL 211 - 201 D 1

Group No. PB 0199 - 2

SLB	UELAK 211 - 33
FAFNIR	RAK - 2 - 1/16
NTN	UELPL 211 - 201 D 1 W 3

Group No. PB 0199 - 3

SLB	SAAK 211 - 33
FAFNIR	VAK - 2 - 1/16

Figure MU 03

Standard Duty Pillow Blocks - Cast Housing
Eccentric Locking Collar Type, Set Screws Type



2.0625 in	ID	52.39 mm
2.5000 in	SB	63.50 mm
6.7717 in	BC fix	172.00 mm
6.5354 in	BC min	166.00 mm
7.0079 in	BC max	178.00 mm

Group No. PB 0200 - 1

SLB	UCP 211 - 33
FAFNIR	RASC - 2 - 1/16
NTN	UCP 211 - 201 D 1

Group No. PB 0200 - 2

SLB	UELPL 211 - 33
FAFNIR	RAS - 2 - 1/16
NTN	UELPL 211 - 201 D 1 W 3

Group No. PB 0200 - 3

SLB	SAP 211 - 33
FAFNIR	VAS - 2 - 1/16

Figure MU 04

Standard Duty Pillow Blocks - Cast Housing
Set Screws Type



2.0625 in	ID	52.39 mm
2.5000 in	SB	63.50 mm
4.0945 in	BC fix	104.00 mm

Group No. PB 0201 - 1

SLB	UCPA 211 - 33
FYH	UCPA 211 - 33

Figure MU 07

Medium Duty Pillow Blocks - Cast Housing
Set Screws Type



2.0625 in	ID	52.39 mm
2.7480 in	SB	69.80 mm
7.2441 in	BC fix	184.00 mm
6.9291 in	BC min	176.00 mm
7.5591 in	BC max	192.00 mm

Group No. PB 0202 - 1

SLB	UCP X11 - 33
NTN	UCP X11 - 201 D 1

Figure MU 08

Heavy Duty Pillow Blocks - Cast Housing
Set Screws Type



2.0625 in	ID	52.39 mm
3.1496 in	SB	80.00 mm
9.2913 in	BC fix	236.00 mm
8.6614 in	BC min	220.00 mm
9.9213 in	BC max	252.00 mm

Group No. PB 0203 - 1

SLB	UCP 311 - 33
NTN	UCP 311 - 201 D 1

Figure MU 02

Standard Duty Pillow Blocks - Cast Housing
Eccentric Locking Collar Type, Set Screws Type



2.1250 in	ID	53.98 mm
2.4370 in	SB	61.90 mm
7.1260 in	BC fix	181.00 mm
6.8110 in	BC min	173.00 mm
7.4409 in	BC max	189.00 mm

Group No. PB 0204 - 1

SLB	UCAK 211 - 34
ASAHI	UCLP 211 - 34
FYH	SL 211 - 34
NACHI	UCLP 211 - 34
NTN	UCPL 211 - 202 D 1
RHP	SL 2 1/8
SEALMASTER	NPL - 34

Group No. PB 0204 - 2

SLB	UELAK 211 - 34
FAFNIR	RAK - 2 - 1/8
NTN	UELPL 211 - 202 D 1 W 3
RHP	SL 2 1/8 DEC

Group No. PB 0204 - 3

SLB	SAAK 211 - 34
FAFNIR	VAK - 2 - 1/8

Figure MU 03

Standard Duty Pillow Blocks - Cast Housing
Eccentric Locking Collar Type, Set Screws Type



2.1250 in	ID	53.98 mm
2.5000 in	SB	63.50 mm
6.7717 in	BC fix	172.00 mm
6.5354 in	BC min	166.00 mm
7.0079 in	BC max	178.00 mm

Group No. PB 0205 - 1

SLB	UCP 211 - 34
ASAHI	UCP 211 - 34
FAFNIR	RASC - 2 - 1/8
FYH	UCP 211 - 34
NACHI	UCP 211 - 34
NSK	UCP 211 - 34 S
NTN	UCP 211 - 202 D 1
RHP	NP 2 1/8
SEALMASTER	NP - 34

Group No. PB 0205 - 2

SLB	UEL211 - 34
FAFNIR	RAS - 2 - 1/8
NACHI	UGP 211 - 34 + ER
NTN	UEL211 - 202 D 1 W 3
RHP	NP 2 1/8 DEC

Group No. PB 0205 - 3

SLB	SAP 211 - 34
FAFNIR	VAS - 2 - 1/8

Figure MU 04

Standard Duty Pillow Blocks - Cast Housing
Set Screws Type



2.1250 in	ID	53.98 mm
2.5000 in	SB	63.50 mm
4.0945 in	BC fix	104.00 mm

Group No. PB 0206 - 1

SLB	UCPA 211 - 34
RHP	SNP 2 1/8

Figure MU 07

Medium Duty Pillow Blocks - Cast Housing
Set Screws Type



2.1250 in	ID	53.98 mm
2.7480 in	SB	69.80 mm
7.2441 in	BC fix	184.00 mm
6.9291 in	BC min	176.00 mm
7.5591 in	BC max	192.00 mm

Group No. PB 0207 - 1

SLB	UCP X11 - 34
ASAHI	UCP X11 - 34
NTN	UCP X11 - 202 D 1

Figure MU 08

Heavy Duty Pillow Blocks - Cast Housing
Set Screws Type



2.1250 in	ID	53.98 mm
3.1496 in	SB	80.00 mm
9.2913 in	BC fix	236.00 mm
8.6614 in	BC min	220.00 mm
9.9213 in	BC max	252.00 mm

Group No. PB 0208 - 1

SLB	UCP 311 - 34
ASAHI	UCP 311 - 34
NSK	UCP 311 - 34 S
NTN	UCP 311 - 202 D 1

Figure MU 02

Standard Duty Pillow Blocks - Cast Housing
Eccentric Locking Collar Type, Set Screws Type



2.1654 in	ID	55.00 mm
2.4370 in	SB	61.90 mm
7.1260 in	BC fix	181.00 mm
6.8110 in	BC min	173.00 mm
7.4409 in	BC max	189.00 mm

Group No. PB 0209 - 1

SLB	UCAK 211
ASAHI	UCLP 211
FYH	SL 211
INA	RAKY 55
LINK - BELT	PL 3 - U 2 M 55 N
NACHI	UCLP 211
NTN	UCPL 211 D 1
RHP	SL 55
SEALMASTER	NPL - 211
SNR	SL 55

Group No. PB 0209 - 2

SLB	UELAK 211
FAFNIR	RAK - 55
INA	RAK 55
NTN	UELPL 211 D 1 W 3
RHP	SL 55 DEC

Group No. PB 0209 - 3	
SLB	SAAK 211
FAFNIR	VAK - 55
INA	PAK 55

Group No. PB 0211 - 1	
SLB	UCPA 211
RHP	SNP 55
SKF	SYF 55 TM

2.1654 in	ID	55.00 mm
3.1496 in	SB	80.00 mm
9.2913 in	BC fix	236.00 mm
8.6614 in	BC min	220.00 mm
9.9213 in	BC max	252.00 mm

Figure MU 03	
<i>Standard Duty Pillow Blocks - Cast Housing</i>	
<i>Eccentric Locking Collar Type, Set Screws Type</i>	
2.1654 in	ID 55.00 mm
2.5000 in	SB 63.50 mm
6.7717 in	BC fix 172.00 mm
6.5354 in	BC min 166.00 mm
7.0079 in	BC max 178.00 mm

Figure MU 07	
<i>Medium Duty Pillow Blocks - Cast Housing</i>	
<i>Set Screws Type</i>	
2.1654 in	ID 55.00 mm
2.7480 in	SB 69.80 mm
7.2441 in	BC fix 184.00 mm
6.9291 in	BC min 176.00 mm
7.5591 in	BC max 192.00 mm

Group No. PB 0215 - 1	
SLB	UCP 311
ASAHI	UCP 311
FYH	UCP 311
NSK	UCP 311
NTN	UCP 311 D 1

Group No. PB 0210 - 1	
SLB	UCP 211
ASAHI	UCP 211
FAFNIR	RASC - 55
FAG	SG 56211
FYH	UCP 211
INA	RASEY 55
KOYO	UCP 211
LINK - BELT	P 3 - U 2 M 55 N
NACHI	UCP 211
NSK	UCP 211
NTN	UCP 211 D 1
RHP	NP 55
SEALMASTER	NP - 211
SKF	SY 55 TM
SNR	NP 55

Group No. PB 0212 - 1	
SLB	UCP X11
ASAHI	UCP X11
FYH	UCP X11
NSK	UCP X11
NTN	UCP X11 D 1
RHP	MP 55
SEALMASTER	MP - 311

Figure MU 02	
<i>Standard Duty Pillow Blocks - Cast Housing</i>	
<i>Eccentric Locking Collar Type, Set Screws Type</i>	
2.1875 in	ID 55.56 mm
2.4370 in	SB 61.90 mm
7.1260 in	BC fix 181.00 mm
6.8110 in	BC min 173.00 mm
7.4409 in	BC max 189.00 mm

Group No. PB 0210 - 2	
SLB	UELPL 211
FAFNIR	RAS - 55
FYH	NAP 211
INA	RASE 55
NACHI	UGP 211 + ER
NSK	EWP 211
NTN	UELPL 211 D1 W 3
RHP	NP 55 DEC
SKF	SY 55 WM

Figure MU 05	
<i>Standard Duty Pillow Blocks - Cast Housing</i>	
<i>Adapter Type</i>	
2.1654 in	ID 55.00 mm
2.7520 in	SB 69.90 mm
7.3228 in	BC fix 186.00 mm
8.1102 in	BC min 206.00 mm
6.5354 in	BC max 166.00 mm

Group No. PB 0216 - 1	
SLB	UCAK 211 - 35
ASAHI	UCLP 211 - 35
BROWNING	VPLS - 235
FYH	SL 211 - 35
LINK - BELT	PL 3 - U 235 N
NACHI	UCLP 211 - 35
NTN	UCPL 211 - 203 D 1
RHP	SL 2 3/16
SEALMASTER	NPL - 35
SKF	SYH 2 - 3/16 TM

Group No. PB 0210 - 3	
SLB	SAP 211
FAFNIR	VAS - 55
INA	PASE 55
KOYO	GARAP 203 MA
SKF	SY 55 FM

Group No. PB 0213 - 1	
SLB	UKP 212
ASAHI	UKP 212
FYH	UKP 212
NACHI	UKP 212
NSK	UKP 212
NTN	UKP 212 D 1

Group No. PB 0216 - 2	
SLB	UELAK 211 - 35
BROWNING	VPLE - 235
FAFNIR	RAK - 2 - 3/16
INA	RAK 2 3/16"
LINK - BELT	PL 3 - Y 235 N
NTN	UELPL 211 - 203 D 1 W 3
RHP	SL 2 3/16 DEC
SKF	SYH 2 - 3/16 WM

Figure MU 04	
<i>Standard Duty Pillow Blocks - Cast Housing</i>	
<i>Set Screws Type</i>	
2.1654 in	ID 55.00 mm
2.5000 in	SB 63.50 mm
4.0945 in	BC fix 104.00 mm

Figure MU 06	
<i>Standard Duty Pillow Blocks - Cast Housing</i>	
<i>Adapter Type</i>	
2.1654 in	ID 55.00 mm
2.7520 in	SB 69.90 mm
8.5039 in	BC fix 0216 mm

Group No. PB 0216 - 3	
SLB	SAAK 211 - 35
FAFNIR	VAK - 2 - 3/16
INA	PAK 2 3/16"
SKF	SYH 2 - 3/16 FM

Group No. PB 0214 - 1	
SLB	UKPA 212
FYH	UKPA 212

Figure MU 08	
<i>Heavy Duty Pillow Blocks - Cast Housing</i>	
<i>Set Screws Type</i>	

Figure MU 03	
<i>Standard Duty Pillow Blocks - Cast Housing</i>	
<i>Eccentric Locking Collar Type, Set Screws Type</i>	

2.1875 in	ID	55.56 mm
2.5000 in	SB	63.50 mm
6.7717 in	BC fix	172.00 mm
6.5354 in	BC min	166.00 mm
7.0079 in	BC max	178.00 mm

Group No. PB 0217 - 1

SLB	UCP 211 - 35
ASAHI	UCP 211 - 35
BROWNING	VPS - 235
FAFNIR	RASC - 2 - 3/16
FAG	SG 56211.203
FYH	UCP 211 - 35
KOYO	UCP 211 - 35
LINK - BELT	P 3 - U 235 N
NACHI	UCP 211 - 35
NTN	UCP 211 - 203 D 1
RHP	NP 2 3/16
SEALMASTER	NP - 35
SKF	SY 2 - 3/16 TM

Group No. PB 0217 - 2

SLB	UELPL 211 - 35
BROWNING	VPE - 235
FAFNIR	RAS - 2 - 3/16
FYH	NAP 211 - 35
INA	RASE 2 3/16"
LINK - BELT	P 3 - Y 235 N
NACHI	UGP 211 - 35 + ER
NTN	UELPL 211 - 203 D 1 W 3
RHP	NP 2 3/16 DEC
SKF	SY 2 - 3/16 WM

Group No. PB 0217 - 3

SLB	SAP 211 - 35
FAFNIR	VAS - 2 - 3/16
INA	PASE 2 3/16"
KOYO	GARAP 203 A
SKF	SY 2 - 3/16 FM

Figure MU 04

*Standard Duty Pillow Blocks - Cast Housing
Set Screws Type*

2.1875 in	ID	55.56 mm
2.5000 in	SB	63.50 mm
4.0945 in	BC fix	104.00 mm

Group No. PB 0218 - 1

SLB	UCPA 211 - 35
RHP	SNP 2 3/16
SKF	SYF 2 - 3/16 TM

Figure MU 07

*Medium Duty Pillow Blocks - Cast Housing
Set Screws Type*

2.1875 in	ID	55.56 mm
2.7480 in	SB	69.80 mm
7.2441 in	BC fix	184.00 mm
6.9291 in	BC min	176.00 mm
7.5591 in	BC max	192.00 mm

Group No. PB 0219 - 1

SLB	UCP X11 - 35
ASAHI	UCP X11 - 35
BROWNING	VPS - 335
FYH	UCP X11 - 35
NTN	UCP X11 - 203 D 1
RHP	MP 2 3/16
SEALMASTER	MP - 35
SKF	SYM 2 - 3/16 TM

Figure MU 08

*Heavy Duty Pillow Blocks - Cast Housing
Set Screws Type*

2.1875 in	ID	55.56 mm
3.1496 in	SB	80.00 mm
9.2913 in	BC fix	236.00 mm
8.6614 in	BC min	220.00 mm
9.9213 in	BC max	252.00 mm

Group No. PB 0220 - 1

SLB	UCP 311 - 35
NTN	UCP 311 - 203 D 1

Figure MU 02

*Standard Duty Pillow Blocks - Cast Housing
Eccentric Locking Collar Type, Set Screws Type*

2.2500 in	ID	57.15 mm
2.6890 in	SB	68.30 mm
7.5197 in	BC fix	191.00 mm
7.2047 in	BC min	183.00 mm
7.8346 in	BC max	199.00 mm

Group No. PB 0221 - 1

SLB	UCAK 212 - 36
ASAHI	UCLP 212 - 36
BROWNING	VPLS - 236
FYH	SL 212 - 36
LINK - BELT	PL 3 - U 236 N
NACHI	UCLP 212 - 36
NTN	UCPL 212 - 204 D 1
RHP	SL 2 1/4
SEALMASTER	NPL - 36
SKF	SYH 2 - 1/4 TM

Group No. PB 0221 - 2

SLB	UELAK 212 - 36
BROWNING	VPLE - 236
FAFNIR	RAK - 2 - 1/4
LINK - BELT	PL 3 - Y 236 N

NTN	UELPL 212 - 204 D 1 W 3
RHP	SL 2 1/4 DEC
SKF	SYH 2 - 1/4 WM

Figure MU 03

*Standard Duty Pillow Blocks - Cast Housing
Eccentric Locking Collar Type, Set Screws Type*

2.2500 in	ID	57.15 mm
2.7520 in	SB	69.90 mm
7.3228 in	BC fix	186.00 mm
6.9685 in	BC min	177.00 mm
7.6772 in	BC max	195.00 mm

Group No. PB 0222 - 1

SLB	UCP 212 - 36
ASAHI	UCP 212 - 36
BROWNING	VPS - 236
FAFNIR	RASC - 2 - 1/4
FAG	SG 56212.204
FYH	UCP 212 - 36
KOYO	UCP 212 - 36
LINK - BELT	P 3 - U 236 N
NACHI	UCP 212 - 36
NSK	UCP 212 - 36 S
NTN	UCP 212 - 204 D 1
RHP	NP 2 1/4
SEALMASTER	NP - 36
SKF	SY 2 - 1/4 TM

Group No. PB 0222 - 2

SLB	UELPL 212 - 36
BROWNING	VPE - 236
FAFNIR	RAS - 2 - 1/4
FYH	NAP 212 - 36
LINK - BELT	P 3 - Y 236 N
NACHI	UGP 212 - 36 + ER
NTN	UELPL 212 - 204 D 1 W 3
RHP	NP 2 1/4 DEC
SKF	SY 2 - 1/4 WM

Figure MU 04

*Standard Duty Pillow Blocks - Cast Housing
Set Screws Type*

2.2500 in	ID	57.15 mm
2.7520 in	SB	69.90 mm
4.4882 in	BC fix	114.00 mm

Group No. PB 0223 - 1

SLB	UCPA 212 - 36
RHP	SNP 2 1/4
SKF	SYF 2 - 1/4 TM

Figure MU 07

*Medium Duty Pillow Blocks - Cast Housing
Set Screws Type*

2.2500 in	ID	57.15 mm
3.0000 in	SB	76.20 mm
7.9921 in	BC fix	203.00 mm
7.6772 in	BC min	195.00 mm
8.3071 in	BC max	211.00 mm

Group No. PB 0224 - 1

SLB	UCP X12 - 36
ASAHI	UCP X12 - 36
FYH	UCP X12 - 36
RHP	MP 2 1/4
SEALMASTER	MP - 36

Figure MU 08

Heavy Duty Pillow Blocks - Cast Housing
Set Screws Type



2.2500 in	ID	57.15 mm
3.3465 in	SB	85.00 mm
9.8425 in	BC fix	250.00 mm
9.2520 in	BC min	235.00 mm
10.4331 in	BC max	265.00 mm

Group No. PB 0225 - 1

SLB	UCP 312 - 36
ASAHI	UCP 312 - 36
NSK	UCP 312 - 36 S
NTN	UCP 312 - 204 D 1

Figure MU 02

Standard Duty Pillow Blocks - Cast Housing
Eccentric Locking Collar Type, Set Screws Type



2.3125 in	ID	58.74 mm
2.6890 in	SB	68.30 mm
7.5197 in	BC fix	191.00 mm
7.2047 in	BC min	183.00 mm
7.8346 in	BC max	199.00 mm

Group No. PB 0226 - 1

SLB	UCAK 212 - 37
NTN	UCPL 212 - 205 D 1

Group No. PB 0226 - 2

SLB	UELAK 212 - 37
FAFNIR	RAK - 2 - 5/16
NTN	UELPL 212 - 205 D 1 W 3

Figure MU 03

Standard Duty Pillow Blocks - Cast Housing
Eccentric Locking Collar Type, Set Screws Type



2.3125 in	ID	58.74 mm
2.7520 in	SB	69.90 mm
7.3228 in	BC fix	186.00 mm
6.9685 in	BC min	177.00 mm
7.6772 in	BC max	195.00 mm

Group No. PB 0227 - 1

SLB	UCP 212 - 37
FAFNIR	RASC - 2 - 5/16
NTN	UCP 212 - 205 D 1

Group No. PB 0227 - 2

SLB	UEL212 - 37
FAFNIR	RAS - 2 - 5/16
NTN	UEL212 - 205 D 1 W 3

Figure MU 04

Standard Duty Pillow Blocks - Cast Housing
Set Screws Type



2.3125 in	ID	58.74 mm
2.7520 in	SB	69.90 mm
4.4882 in	BC fix	114.00 mm

Group No. PB 0228 - 1

SLB	UCPA 212 - 37
FYH	UCPA 212 - 37

Figure MU 07

Medium Duty Pillow Blocks - Cast Housing
Set Screws Type



2.3125 in	ID	58.74 mm
3.0000 in	SB	76.20 mm
7.9921 in	BC fix	203.00 mm
7.6772 in	BC min	195.00 mm
8.3071 in	BC max	211.00 mm

Group No. PB 0229 - 1

SLB	UCP X12 - 37
FYH	UCP X12 - 37

Figure MU 08

Heavy Duty Pillow Blocks - Cast Housing
Set Screws Type



2.3125 in	ID	58.74 mm
3.3465 in	SB	85.00 mm
9.8425 in	BC fix	250.00 mm
9.2520 in	BC min	235.00 mm
10.4331 in	BC max	265.00 mm

Group No. PB 0230 - 1

SLB	UCP 312 - 37
NTN	UCP 312 - 205 D 1

Figure MU 02

Standard Duty Pillow Blocks - Cast Housing
Eccentric Locking Collar Type, Set Screws Type



2.3622 in	ID	60.00 mm
2.6890 in	SB	68.30 mm
7.5197 in	BC fix	191.00 mm
7.2047 in	BC min	183.00 mm
7.8346 in	BC max	199.00 mm

Group No. PB 0231 - 1

SLB	UCAK 212
ASAHI	UCLP 212
FYH	SL 212
INA	RAKY 60
LINK - BELT	PL 3 - U 2 M 60 N
NACHI	UCLP 212
NTN	UCPL 212 D 1
RHP	SL 60
SEALMASTER	NPL - 212
SNR	SL 60

Group No. PB 0231 - 2

SLB	UELAK 212
FAFNIR	RAK - 60
INA	RAK 60
NTN	UELPL 212 D 1 W 3
RHP	SL 60 DEC

Figure MU 03

Standard Duty Pillow Blocks - Cast Housing
Eccentric Locking Collar Type, Set Screws Type



2.3622 in	ID	60.00 mm
2.7520 in	SB	69.90 mm
7.3228 in	BC fix	186.00 mm
6.9685 in	BC min	177.00 mm
7.6772 in	BC max	195.00 mm

Group No. PB 0232 - 1

SLB	UCP 212
ASAHI	UCP 212
FAFNIR	RASC - 60
FAG	SG 56212
FYH	UCP 212
INA	RASEY 60
KOYO	UCP 212
LINK - BELT	P 3 - U 2 M 60 N
NACHI	UCP 212
NSK	UCP 212
NTN	UCP 212 D 1
RHP	NP 60
SEALMASTER	NP - 212
SKF	SY 60 TM
SNR	NP 60

Group No. PB 0232 - 2

SLB	UEL212
FAFNIR	RAS - 60
FYH	NAP 212
INA	RASE 60
NACHI	UGP 212 + ER
NSK	EWP 212

NTN	UELPL 212 D 1 W 3
RHP	NP 60 DEC
SKF	SY 60 WM

Figure MU 04
Standard Duty Pillow Blocks - Cast Housing
Set Screws Type

2.3622 in	ID	60.00 mm
2.7520 in	SB	69.90 mm
4.4882 in	BC fix	114.00 mm

Group No. PB 0233 - 1

SLB	UCPA 212
RHP	SNP 60
SKF	SYF 60 TM

Figure MU 05
Standard Duty Pillow Blocks - Cast Housing
Adapter Type

2.3622 in	ID	60.00 mm
3.0000 in	SB	76.20 mm
7.9921 in	BC fix	203.00 mm
8.4646 in	BC min	215.00 mm
7.5197 in	BC max	191.00 mm

Group No. PB 0234 - 1

SLB	UKP 213
ASAHI	UKP 213
FYH	UKP 213
NACHI	UKP 213
NSK	UKP 213
NTN	UKP 213 D 1

Figure MU 06
Standard Duty Pillow Blocks - Cast Housing
Adapter Type

2.3622 in	ID	60.00 mm
3.0000 in	SB	76.20 mm
9.3701 in	BC fix	0238 mm

Group No. PB 0235 - 1

SLB	UKPA 213
FYH	UKPA 213

Figure MU 07
Medium Duty Pillow Blocks - Cast Housing
Set Screws Type

2.3622 in	ID	60.00 mm
3.0000 in	SB	76.20 mm
7.9921 in	BC fix	203.00 mm
7.6772 in	BC min	195.00 mm
8.3071 in	BC max	211.00 mm

Group No. PB 0236 - 1

SLB	UCP X12
ASAHI	UCP X12
FYH	UCP X12
INA	RASEY 60 - MP
NSK	UCP X12
NTN	UCP X12 D 1
RHP	MP 60

Figure MU 08
Heavy Duty Pillow Blocks - Cast Housing
Set Screws Type

2.3622 in	ID	60.00 mm
3.3465 in	SB	85.00 mm
9.8425 in	BC fix	250.00 mm
9.2520 in	BC min	235.00 mm
10.4331 in	BC max	265.00 mm

Group No. PB 0237 - 1

SLB	UCP 312
ASAHI	UCP 312
FYH	UCP 312
INA	RSAOY 60
NSK	UCP 312
NTN	UCP 312 D 1

Figure MU 02
Standard Duty Pillow Blocks - Cast Housing
Eccentric Locking Collar Type, Set Screws Type

2.3750 in	ID	60.33 mm
2.6890 in	SB	68.30 mm
7.5197 in	BC fix	191.00 mm
7.2047 in	BC min	183.00 mm
7.8346 in	BC max	199.00 mm

Group No. PB 0238 - 1

SLB	UCAK 212 - 38
ASAHI	UCLP 212 - 38
FYH	SL 212 - 38
LINK - BELT	PL 3 - U 238 N
NACHI	UCLP 212 - 38
NTN	UCPL 212 - 206 D 1
RHP	SL 2 3/8
SEALMASTER	NPL - 38

Group No. PB 0238 - 2

SLB	UELAK 212 - 38
FAFNIR	RAK - 2 - 3/8
LINK - BELT	PL 3 - Y 238 N
NTN	UELPL 212 - 206 D 1 W 3
RHP	SL 2 3/8 DEC

Figure MU 03
Standard Duty Pillow Blocks - Cast Housing
Eccentric Locking Collar Type, Set Screws Type

2.3750 in	ID	60.33 mm
2.7520 in	SB	69.90 mm
7.3228 in	BC fix	186.00 mm
6.9685 in	BC min	177.00 mm
7.6772 in	BC max	195.00 mm

Group No. PB 0239 - 1

SLB	UCP 212 - 38
ASAHI	UCP 212 - 38
FAFNIR	RASC - 2 - 3/8
FYH	UCP 212 - 38
LINK - BELT	P 3 - U 238 N
NACHI	UCP 212 - 38
NSK	UCP 212 - 38 S
NTN	UCP 212 - 206 D 1
RHP	NP 2 3/8
SEALMASTER	NP - 38

Group No. PB 0239 - 2

SLB	UELPL 212 - 38
FAFNIR	RAS - 2 - 3/8
LINK - BELT	P 3 - Y 238 N
NACHI	UGP 212 - 38 + ER
NTN	UELPL 212 - 206 D 1 W 3
RHP	NP 2 3/8 DEC

Figure MU 04
Standard Duty Pillow Blocks - Cast Housing
Set Screws Type

2.3750 in	ID	60.33 mm
2.7520 in	SB	69.90 mm
4.4882 in	BC fix	114.00 mm

Group No. PB 0240 - 1

SLB	UCPA 212 - 38
RHP	SNP 2 3/8

Figure MU 07
Medium Duty Pillow Blocks - Cast Housing
Set Screws Type

2.3750 in	ID	60.33 mm
3.0000 in	SB	76.20 mm
7.9921 in	BC fix	203.00 mm
7.6772 in	BC min	195.00 mm
8.3071 in	BC max	211.00 mm

Group No. PB 0241 - 1

SLB	UCP X12 - 38
ASAHI	UCP X12 - 38
FYH	UCP X12 - 38
NTN	UCP X12 - 206 D 1

Figure MU 08
Heavy Duty Pillow Blocks - Cast Housing
Set Screws Type

2.3750 in	ID	60.33 mm
3.3465 in	SB	85.00 mm
9.8425 in	BC fix	250.00 mm
9.2520 in	BC min	235.00 mm
10.4331 in	BC max	265.00 mm

Group No. PB 0242 - 1

SLB	UCP 312 - 38
ASAHI	UCP 312 - 38
NSK	UCP 312 - 38 S
NTN	UCP 312 - 206 D 1

Figure MU 02

*Standard Duty Pillow Blocks - Cast Housing
Eccentric Locking Collar Type, Set Screws Type*

2.4375 in	ID	61.91 mm
2.6890 in	SB	68.30 mm
7.5197 in	BC fix	191.00 mm
7.2047 in	BC min	183.00 mm
7.8346 in	BC max	199.00 mm

Group No. PB 0243 - 1

SLB	UCAK 212 - 39
ASAHI	UCLP 212 - 39
BROWNING	VPLS - 239
FYH	SL 212 - 39
INA	RAKY 2 7/16"
LINK - BELT	PL 3 - U 239 N
NACHI	UCLP 212 - 39
NTN	UCPL 212 - 207 D 1
RHP	SL 2 7/16
SEALMASTER	NPL - 39
SKF	SYH 2 - 7/16 TM

Group No. PB 0243 - 2

SLB	UELAK 212 - 39
BROWNING	VPLE - 239
FAFNIR	RAK - 2 - 7/16
INA	RAK 2 7/16"
LINK - BELT	PL 3 - Y 239 N
NTN	UELPL 212 - 207 D 1 W 3
RHP	SL 2 7/16 DEC
SKF	SYH 2 - 7/16 WM

Figure MU 03

*Standard Duty Pillow Blocks - Cast Housing
Eccentric Locking Collar Type, Set Screws Type*

2.4375 in	ID	61.91 mm
2.7520 in	SB	69.90 mm
7.3228 in	BC fix	186.00 mm
6.9685 in	BC min	177.00 mm
7.6772 in	BC max	195.00 mm

Group No. PB 0244 - 1

SLB	UCP 212 - 39
ASAHI	UCP 212 - 39

BROWNING	VPS - 239
FAFNIR	RASC - 2 - 7/16
FAG	SG 56212.207
FYH	UCP 212 - 39
INA	RASEY 2 7/16"
KOYO	UCP 212 - 39
LINK - BELT	P 3 - U 239 N
NACHI	UCP 212 - 39
NTN	UCP 212 - 207 D 1
RHP	NP 2 7/16
SEALMASTER	NP - 39
SKF	SY 2 - 7/16 TM

Group No. PB 0244 - 2

SLB	UEL212 - 39
BROWNING	VPE - 239
FAFNIR	RAS - 2 - 7/16
FYH	NAP 212 - 39
INA	RASE 2 7/16"
LINK - BELT	P 3 - Y 239 N
NACHI	UGP 212 - 39 + ER
NTN	UEL212 - 207 D 1 W 3
RHP	NP 2 7/16 DEC
SKF	SY 2 - 7/16 WM

Figure MU 04

*Standard Duty Pillow Blocks - Cast Housing
Set Screws Type*

2.4375 in	ID	61.91 mm
2.7520 in	SB	69.90 mm
4.4882 in	BC fix	114.00 mm

Group No. PB 0245 - 1

SLB	UCPA 212 - 39
RHP	SNP 2 7/16
SKF	SYF 2 - 7/16 TM

Figure MU 07

*Medium Duty Pillow Blocks - Cast Housing
Set Screws Type*

2.4375 in	ID	61.91 mm
3.0000 in	SB	76.20 mm
7.9921 in	BC fix	203.00 mm
7.6772 in	BC min	195.00 mm
8.3071 in	BC max	211.00 mm

Group No. PB 0246 - 1

SLB	UCP X12 - 39
ASAHI	UCP X12 - 39
BROWNING	VPS - 339
FYH	UCP X12 - 39
NTN	UCP X12 - 207 D 1
RHP	MP 2 7/16
SEALMASTER	MP - 39

Figure MU 08

*Heavy Duty Pillow Blocks - Cast Housing
Set Screws Type*

2.4375 in	ID	61.91 mm
3.3465 in	SB	85.00 mm
9.8425 in	BC fix	250.00 mm
9.2520 in	BC min	235.00 mm
10.4331 in	BC max	265.00 mm

Group No. PB 0247 - 1

SLB	UCP 312 - 39
NTN	UCP 312 - 207 D 1

Figure MU 02

*Standard Duty Pillow Blocks - Cast Housing
Eccentric Locking Collar Type, Set Screws Type*

2.5000 in	ID	63.50 mm
2.9370 in	SB	74.60 mm
7.9921 in	BC fix	203.00 mm
7.6772 in	BC min	195.00 mm
8.3071 in	BC max	211.00 mm

Group No. PB 0248 - 1

SLB	UCAK 213 - 40
ASAHI	UCLP 213 - 40
NACHI	UCLP 213 - 40
RHP	SL 2 1/2

Group No. PB 0248 - 2

SLB	UELAK 213 - 40
RHP	SL 2 1/2 DEC

Figure MU 03

*Standard Duty Pillow Blocks - Cast Housing
Eccentric Locking Collar Type, Set Screws Type*

2.5000 in	ID	63.50 mm
3.0000 in	SB	76.20 mm
7.9921 in	BC fix	203.00 mm
7.6378 in	BC min	194.00 mm
8.3465 in	BC max	212.00 mm

Group No. PB 0249 - 1

SLB	UCP 213 - 40
ASAHI	UCP 213 - 40
FYH	UCP 213 - 40
INA	RASEY 2 1/2" - 213
KOYO	UCP 213 - 40
LINK - BELT	P 3 - U 240 N
NACHI	UCP 213 - 40
NSK	UCP 213 - 40 S
NTN	UCP 213 - 208 D 1
RHP	NP 2 1/2
SKF	SY 2 - 1/2 TM

Group No. PB 0249 - 2

SLB	UEL P 213 - 40
FYH	NAP 213 - 40
NTN	UEL P 213 - 208 D 1 W 3
RHP	NP 2 1/2 DEC

Figure MU 04
Standard Duty Pillow Blocks - Cast Housing
Set Screws Type

2.5000 in	ID	63.50 mm
3.0000 in	SB	76.20 mm
4.8819 in	BC fix	124.00 mm

Group No. PB 0250 - 1

SLB	UCA P 213 - 40
FYH	UCA P 213 - 40

Figure MU 07
Medium Duty Pillow Blocks - Cast Housing
Set Screws Type

2.5000 in	ID	63.50 mm
3.0000 in	SB	76.20 mm
7.9921 in	BC fix	203.00 mm
7.6772 in	BC min	195.00 mm
8.3071 in	BC max	211.00 mm

Group No. PB 0251 - 1

SLB	UC P X13 - 40
ASAHI	UC P X13 - 40
BROWNING	VPS - 340
FYH	UC P X13 - 40
INA	RASEY 2 1/2" - MP
NTN	UC P X13 - 208 D 1
RHP	MP 2 1/2
SEALMASTER	MP - 40
SKF	SYM 2 - 1/2 TM

Figure MU 08
Heavy Duty Pillow Blocks - Cast Housing
Set Screws Type

2.5000 in	ID	63.50 mm
3.5433 in	SB	90.00 mm
10.2362 in	BC fix	260.00 mm
9.5276 in	BC min	242.00 mm
10.9449 in	BC max	278.00 mm

Group No. PB 0252 - 1

SLB	UC P 313 - 40
ASAHI	UC P 313 - 40
FYH	UC P 313 - 40
NSK	UC P 313 - 40 S
NTN	UC P 313 - 208 D 1

Figure MU 02
Standard Duty Pillow Blocks - Cast Housing
Eccentric Locking Collar Type, Set Screws Type

2.5591 in	ID	65.00 mm
2.9370 in	SB	74.60 mm
7.9921 in	BC fix	203.00 mm
7.6772 in	BC min	195.00 mm
8.3071 in	BC max	211.00 mm

Group No. PB 0253 - 1

SLB	UCA K 213
ASAHI	UCL P 213
NACHI	UCL P 213
RHP	SL 65

Group No. PB 0253 - 2

SLB	UEL AK 213
RHP	SL 65 DEC

Figure MU 03
Standard Duty Pillow Blocks - Cast Housing
Eccentric Locking Collar Type, Set Screws Type

2.5591 in	ID	65.00 mm
3.0000 in	SB	76.20 mm
7.9921 in	BC fix	203.00 mm
7.6378 in	BC min	194.00 mm
8.3465 in	BC max	212.00 mm

Group No. PB 0254 - 1

SLB	UC P 213
ASAHI	UC P 213
FYH	UC P 213
INA	RASEY 65 - 213
KOYO	UC P 213
LINK - BELT	P 3 - U 2 M 65 N
NACHI	UC P 213
NSK	UC P 213
NTN	UC P 213 D 1
RHP	NP 65
SKF	SY 65 TM

Group No. PB 0254 - 2

SLB	UEL P 213
FYH	NAP 213
NTN	UEL P 213 D 1 W 3
RHP	NP 65 DEC

Figure MU 04
Standard Duty Pillow Blocks - Cast Housing
Set Screws Type

2.5591 in	ID	65.00 mm
3.0000 in	SB	76.20 mm
4.8819 in	BC fix	124.00 mm

Group No. PB 0255 - 1

SLB	UCA P 213
FYH	UCA P 213

Figure MU 07
Medium Duty Pillow Blocks - Cast Housing
Set Screws Type

2.5591 in	ID	65.00 mm
3.0000 in	SB	76.20 mm
7.9921 in	BC fix	203.00 mm
7.6772 in	BC min	195.00 mm
8.3071 in	BC max	211.00 mm

Group No. PB 0256 - 1

SLB	UC P X13
ASAHI	UC P X13
FYH	UC P X13
NSK	UC P X13
NTN	UC P X13 D 1
RHP	MP 65
SEALMASTER	MP - 313

Figure MU 08
Heavy Duty Pillow Blocks - Cast Housing
Set Screws Type

2.5591 in	ID	65.00 mm
3.5433 in	SB	90.00 mm
10.2362 in	BC fix	260.00 mm
9.5276 in	BC min	242.00 mm
10.9449 in	BC max	278.00 mm

Group No. PB 0257 - 1

SLB	UC P 313
ASAHI	UC P 313
FYH	UC P 313
NSK	UC P 313
NTN	UC P 313 D 1

Figure MU 02
Standard Duty Pillow Blocks - Cast Housing
Eccentric Locking Collar Type, Set Screws Type

2.5625 in	ID	65.09 mm
2.9370 in	SB	74.60 mm
7.9921 in	BC fix	203.00 mm
7.6772 in	BC min	195.00 mm
8.3071 in	BC max	211.00 mm

Group No. PB 0258 - 1

SLB	UCA K 213 - 41
FYH	UCA K 213 - 41

Figure MU 03
Standard Duty Pillow Blocks - Cast Housing
Eccentric Locking Collar Type, Set Screws Type

2.5591 in	ID	65.00 mm
3.0000 in	SB	76.20 mm
4.8819 in	BC fix	124.00 mm

2.5625 in	ID	65.09 mm
3.0000 in	SB	76.20 mm
7.9921 in	BC fix	203.00 mm
7.6378 in	BC min	194.00 mm
8.3465 in	BC max	212.00 mm

Group No. PB 0259 - 1

SLB	UCP 213 - 41
NTN	UCP 213 - 209 D 1

Group No. PB 0259 - 2

SLB	UELP 213 - 41
NTN	UELP 213 - 209 D 1 W 3

Figure MU 04

Standard Duty Pillow Blocks - Cast Housing
Set Screws Type

2.5625 in	ID	65.09 mm
3.0000 in	SB	76.20 mm
4.8819 in	BC fix	124.00 mm

Group No. PB 0260 - 1

SLB	UCPA 213 - 41
FYH	UCPA 213 - 41

Figure MU 07

Medium Duty Pillow Blocks - Cast Housing
Set Screws Type

2.5625 in	ID	65.09 mm
3.0000 in	SB	76.20 mm
7.9921 in	BC fix	203.00 mm
7.6772 in	BC min	195.00 mm
8.3071 in	BC max	211.00 mm

Group No. PB 0261 - 1

SLB	UCP X13 - 41
NTN	UCP X13 - 209 D 1

Figure MU 08

Heavy Duty Pillow Blocks - Cast Housing
Set Screws Type

2.5625 in	ID	65.09 mm
3.5433 in	SB	90.00 mm
10.2362 in	BC fix	260.00 mm
9.5276 in	BC min	242.00 mm
10.9449 in	BC max	278.00 mm

Group No. PB 0262 - 1

SLB	UCP 313 - 41
NTN	UCP 313 - 209 D 1

Figure MU 02

Standard Duty Pillow Blocks - Cast Housing
Eccentric Locking Collar Type, Set Screws Type

2.6250 in	ID	66.68 mm
3.0630 in	SB	77.80 mm
8.2677 in	BC fix	210.00 mm
7.9528 in	BC min	202.00 mm
8.5827 in	BC max	218.00 mm

Group No. PB 0263 - 1

SLB	UCAK 214 - 42
FYH	UCAK 214 - 42

Figure MU 03

Standard Duty Pillow Blocks - Cast Housing
Eccentric Locking Collar Type, Set Screws Type

2.6250 in	ID	66.68 mm
3.1260 in	SB	79.40 mm
8.2677 in	BC fix	210.00 mm
7.9134 in	BC min	201.00 mm
8.6220 in	BC max	219.00 mm

Group No. PB 0264 - 1

SLB	UCP 214 - 42
NTN	UCP 214 - 210 D 1

Group No. PB 0264 - 2

SLB	UELP 214 - 42
NTN	UELP 214 - 210 D 1 W 3

Figure MU 07

Medium Duty Pillow Blocks - Cast Housing
Set Screws Type

2.6250 in	ID	66.68 mm
3.5000 in	SB	88.90 mm
9.0157 in	BC fix	229.00 mm
8.7008 in	BC min	221.00 mm
9.3307 in	BC max	237.00 mm

Group No. PB 0265 - 1

SLB	UCP X14 - 42
NTN	UCP X14 - 210 D 1

Figure MU 08

Heavy Duty Pillow Blocks - Cast Housing
Set Screws Type

2.6250 in	ID	66.68 mm
3.7402 in	SB	95.00 mm
11.0236 in	BC fix	280.00 mm
10.3150 in	BC min	262.00 mm
11.7323 in	BC max	298.00 mm

Group No. PB 0266 - 1

SLB	UCP 314 - 42
NTN	UCP 314 - 210 D 1

Figure MU 02

Standard Duty Pillow Blocks - Cast Housing
Eccentric Locking Collar Type, Set Screws Type

2.6875 in	ID	68.26 mm
3.0630 in	SB	77.80 mm
8.2677 in	BC fix	210.00 mm
7.9528 in	BC min	202.00 mm
8.5827 in	BC max	218.00 mm

Group No. PB 0267 - 1

SLB	UCAK 214 - 43
BROWNING	VPLS - 243
RHP	SL 2 11/16

Group No. PB 0267 - 2

SLB	UELAK 214 - 43
BROWNING	VPLE - 243
RHP	SL 2 11/16 DEC

Figure MU 03

Standard Duty Pillow Blocks - Cast Housing
Eccentric Locking Collar Type, Set Screws Type

2.6875 in	ID	68.26 mm
3.1260 in	SB	79.40 mm
8.2677 in	BC fix	210.00 mm
7.9134 in	BC min	201.00 mm
8.6220 in	BC max	219.00 mm

Group No. PB 0268 - 1

SLB	UCP 214 - 43
LINK - BELT	P 3 - U 243 N
NTN	UCP 214 - 211 D 1
RHP	NP 2 11/16

Group No. PB 0268 - 2

SLB	UELP 214 - 43
NTN	UELP 214 - 211 D 1 W 3

Figure MU 07

Medium Duty Pillow Blocks - Cast Housing
Set Screws Type

2.6875 in	ID	68.26 mm
3.5000 in	SB	88.90 mm
9.0157 in	BC fix	229.00 mm
8.7008 in	BC min	221.00 mm
9.3307 in	BC max	237.00 mm

Group No. PB 0269 - 1

SLB	UCP X14 - 43
ASAHI	UCP X14 - 4 3
BROWNING	VPS - 343
NTN	UCP X14 - 211 D 1
RHP	MP 2 11/16
SEALMASTER	MP - 43
SKF	SYM 2 - 11/16 TM

Figure MU 08

*Heavy Duty Pillow Blocks - Cast Housing
Set Screws Type*

2.6875 in	ID	68.26 mm
3.7402 in	SB	95.00 mm
11.0236 in	BC fix	280.00 mm
10.3150 in	BC min	262.00 mm
11.7323 in	BC max	298.00 mm

Group No. PB 0270 - 1

SLB	UCP 314 - 43
NTN	UCP 314 - 211 D 1

Figure MU 02

*Standard Duty Pillow Blocks - Cast Housing
Eccentric Locking Collar Type, Set Screws Type*

2.7500 in	ID	69.85 mm
3.0630 in	SB	77.80 mm
8.2677 in	BC fix	210.00 mm
7.9528 in	BC min	202.00 mm
8.5827 in	BC max	218.00 mm

Group No. PB 0271 - 1

SLB	UCAK 214 - 44
RHP	SL 2 3/4

Group No. PB 0271 - 2

SLB	UELAK 214 - 44
RHP	SL 2 3/4 DEC

Figure MU 03

*Standard Duty Pillow Blocks - Cast Housing
Eccentric Locking Collar Type, Set Screws Type*

2.7500 in	ID	69.85 mm
3.1260 in	SB	79.40 mm
8.2677 in	BC fix	210.00 mm
7.9134 in	BC min	201.00 mm
8.6220 in	BC max	219.00 mm

Group No. PB 0272 - 1

SLB	UCP 214 - 44
ASAHI	UCP 214 - 44
FYH	UCP 214 - 44
LINK - BELT	P 3 - U 244 N
NACHI	UCP 214 - 44
NSK	UCP 214 - 44 S
NTN	UCP 214 - 212 D 1
RHP	NP 2 3/4

Group No. PB 0272 - 2

SLB	UEL214 - 44
NTN	UEL214 - 212 D 1 W 3

Figure MU 07

*Medium Duty Pillow Blocks - Cast Housing
Set Screws Type*

2.7500 in	ID	69.85 mm
3.5000 in	SB	88.90 mm
9.0157 in	BC fix	229.00 mm
8.7008 in	BC min	221.00 mm
9.3307 in	BC max	237.00 mm

Group No. PB 0273 - 1

SLB	UCP X14 - 44
ASAHI	UCP X14 - 44
FYH	UCP X14 - 44
NTN	UCP X14 - 212 D 1
RHP	MP 2 3/4

Figure MU 08

*Heavy Duty Pillow Blocks - Cast Housing
Set Screws Type*

2.7500 in	ID	69.85 mm
3.7402 in	SB	95.00 mm
11.0236 in	BC fix	280.00 mm
10.3150 in	BC min	262.00 mm
11.7323 in	BC max	298.00 mm

Group No. PB 0274 - 1

SLB	UCP 314 - 44
ASAHI	UCP 314 - 44
FYH	UCP 314 - 44
NSK	UCP 314 - 44 S
NTN	UCP 314 - 212 D 1

Figure MU 02

*Standard Duty Pillow Blocks - Cast Housing
Eccentric Locking Collar Type, Set Screws Type*

2.7559 in	ID	70.00 mm
3.0630 in	SB	77.80 mm
8.2677 in	BC fix	210.00 mm
7.9528 in	BC min	202.00 mm
8.5827 in	BC max	218.00 mm

Group No. PB 0275 - 1

SLB	UCAK 214
RHP	SL 70

Group No. PB 0275 - 2

SLB	UELAK 214
RHP	SL 70 DEC

Figure MU 03

*Standard Duty Pillow Blocks - Cast Housing
Eccentric Locking Collar Type, Set Screws Type*

2.7559 in	ID	70.00 mm
3.1260 in	SB	79.40 mm
8.2677 in	BC fix	210.00 mm
7.9134 in	BC min	201.00 mm
8.6220 in	BC max	219.00 mm

Group No. PB 0276 - 1

SLB	UCP 214
ASAHI	UCP 214
FYH	UCP 214
INA	RASEY 70
NACHI	UCP 214
NSK	UCP 214
NTN	UCP 214 D 1
RHP	NP 70
SKF	SY 70 TM
SNR	NP 70

Group No. PB 0276 - 2

SLB	UEL214
INA	RASE 70 S
NTN	UEL214 D 1 W 3
RHP	NP 70 DEC

Figure MU 07

*Medium Duty Pillow Blocks - Cast Housing
Set Screws Type*

2.7559 in	ID	70.00 mm
3.5000 in	SB	88.90 mm
9.0157 in	BC fix	229.00 mm
8.7008 in	BC min	221.00 mm
9.3307 in	BC max	237.00 mm

Group No. PB 0277 - 1

SLB	UCP X14
ASAHI	UCP X14
FYH	UCP X14
NSK	UCP X14
NTN	UCP X14 D 1
RHP	MP 70
SEALMASTER	MP - 314

Figure MU 08

*Heavy Duty Pillow Blocks - Cast Housing
Set Screws Type*

2.7559 in	ID	70.00 mm
3.7402 in	SB	95.00 mm
11.0236 in	BC fix	280.00 mm
10.3150 in	BC min	262.00 mm
11.7323 in	BC max	298.00 mm

Group No. PB 0278 - 1

SLB	UCP 314
ASAHI	UCP 314

FYH	UCP 314
NSK	UCP 314
NTN	UCP 314 D 1

Figure MU 02
Standard Duty Pillow Blocks - Cast Housing
Eccentric Locking Collar Type, Set Screws Type

2.8125 in	ID	71.44 mm
3.2520 in	SB	82.60 mm
9.4882 in	BC fix	241.00 mm
9.0157 in	BC min	229.00 mm
9.9606 in	BC max	253.00 mm

Group No. PB 0279 - 1

SLB	UCAK 215 - 45
FYH	UCAK 215 - 45

Figure MU 03
Standard Duty Pillow Blocks - Cast Housing
Eccentric Locking Collar Type, Set Screws Type

2.8125 in	ID	71.44 mm
3.2520 in	SB	82.60 mm
8.5433 in	BC fix	217.00 mm
8.1890 in	BC min	208.00 mm
8.8976 in	BC max	226.00 mm

Group No. PB 0280 - 1

SLB	UCP 215 - 45
NTN	UCP 215 - 213 D 1

Group No. PB 0280 - 2

SLB	UEL P 215 - 45
NTN	UEL P 215 - 213 D 1 W 3

Figure MU 07
Medium Duty Pillow Blocks - Cast Housing
Set Screws Type

2.8125 in	ID	71.44 mm
3.5000 in	SB	88.90 mm
9.0157 in	BC fix	229.00 mm
8.7008 in	BC min	221.00 mm
9.3307 in	BC max	237.00 mm

Group No. PB 0281 - 1

SLB	UCP X15 - 45
NTN	UCP X15 - 213 D 1

Figure MU 08
Heavy Duty Pillow Blocks - Cast Housing
Set Screws Type

2.8125 in	ID	71.44 mm
3.9370 in	SB	100.00 mm
11.4173 in	BC fix	290.00 mm
10.7087 in	BC min	272.00 mm
12.1260 in	BC max	308.00 mm

Group No. PB 0282 - 1

SLB	UCP 315 - 45
NTN	UCP 315 - 213 D 1

Figure MU 02
Standard Duty Pillow Blocks - Cast Housing
Eccentric Locking Collar Type, Set Screws Type

2.8750 in	ID	73.03 mm
3.2520 in	SB	82.60 mm
9.4882 in	BC fix	241.00 mm
9.0157 in	BC min	229.00 mm
9.9606 in	BC max	253.00 mm

Group No. PB 0283 - 1

SLB	UCAK 215 - 46
RHP	SL 2 7/8

Group No. PB 0283 - 2

SLB	UELAK 215 - 46
RHP	SL 2 7/8 DEC

Figure MU 03
Standard Duty Pillow Blocks - Cast Housing
Eccentric Locking Collar Type, Set Screws Type

2.8750 in	ID	73.03 mm
3.2520 in	SB	82.60 mm
8.5433 in	BC fix	217.00 mm
8.1890 in	BC min	208.00 mm
8.8976 in	BC max	226.00 mm

Group No. PB 0284 - 1

SLB	UCP 215 - 46
NTN	UCP 215 - 214 D 1
RHP	NP 2 7/8

Group No. PB 0284 - 2

SLB	UEL P 215 - 46
NTN	UEL P 215 - 214 D 1 W 3

Figure MU 07
Medium Duty Pillow Blocks - Cast Housing
Set Screws Type

2.8750 in	ID	73.03 mm
3.5000 in	SB	88.90 mm
9.0157 in	BC fix	229.00 mm
8.7008 in	BC min	221.00 mm
9.3307 in	BC max	237.00 mm

Group No. PB 0285 - 1

SLB	UCP X15 - 46
NTN	UCP X15 - 214 D 1

Figure MU 08
Heavy Duty Pillow Blocks - Cast Housing
Set Screws Type

2.8750 in	ID	73.03 mm
3.9370 in	SB	100.00 mm
11.4173 in	BC fix	290.00 mm
10.7087 in	BC min	272.00 mm
12.1260 in	BC max	308.00 mm

Group No. PB 0286 - 1

SLB	UCP 315 - 46
NTN	UCP 315 - 214 D 1

Figure MU 02
Standard Duty Pillow Blocks - Cast Housing
Eccentric Locking Collar Type, Set Screws Type

2.9375 in	ID	74.61 mm
3.2520 in	SB	82.60 mm
9.4882 in	BC fix	241.00 mm
9.0157 in	BC min	229.00 mm
9.9606 in	BC max	253.00 mm

Group No. PB 0287 - 1

SLB	UCAK 215 - 47
BROWNING	VPLS - 247
INA	RAKY 2 15/16"
RHP	SL 2 15/16

Group No. PB 0287 - 2

SLB	UELAK 215 - 47
BROWNING	VPLE - 247
FAFNIR	RAK - 2 - 15/16
INA	RAK 2 15/16" S
RHP	SL 2 15/16 DEC

Figure MU 03
Standard Duty Pillow Blocks - Cast Housing
Eccentric Locking Collar Type, Set Screws Type

2.9375 in	ID	74.61 mm
3.2520 in	SB	82.60 mm
8.5433 in	BC fix	217.00 mm
8.1890 in	BC min	208.00 mm
8.8976 in	BC max	226.00 mm

Group No. PB 0288 - 1

SLB	UCP 215 - 47
BROWNING	VPS - 247
FAFNIR	RASC - 2 - 15/16
INA	RASEY 2 15/16"

LINK - BELT	P 3 - U 247 N
NTN	UCP 215 - 215 D 1
RHP	NP 2 15/16
SKF	SY 2 - 15/16 TM

Group No. PB 0288 - 2

SLB	UEL P 215 - 47
BROWNING	VPE - 247
FAFNIR	RAS - 2 - 15/16
FYH	NAP 215 - 47
INA	RASE 2 15/16" S
NTN	UEL P 215 - 215 D 1 W 3

Figure MU 07

Medium Duty Pillow Blocks - Cast Housing
Set Screws Type

2.9375 in	ID	74.61 mm
3.5000 in	SB	88.90 mm
9.0157 in	BC fix	229.00 mm
8.7008 in	BC min	221.00 mm
9.3307 in	BC max	237.00 mm

Group No. PB 0289 - 1

SLB	UCP X15 - 47
ASAHI	UCP X15 - 47
BROWNING	VPS - 347
NTN	UCP X15 - 215 D 1
RHP	MP 2 15/16
SEALMASTER	MP - 47
SKF	SYM 2 - 15/16 TM

Figure MU 08

Heavy Duty Pillow Blocks - Cast Housing
Set Screws Type

2.9375 in	ID	74.61 mm
3.9370 in	SB	100.00 mm
11.4173 in	BC fix	290.00 mm
10.7087 in	BC min	272.00 mm
12.1260 in	BC max	308.00 mm

Group No. PB 0290 - 1

SLB	UCP 315 - 47
NTN	UCP 315 - 215 D 1

Figure MU 02

Standard Duty Pillow Blocks - Cast Housing
Eccentric Locking Collar Type, Set Screws Type

2.9528 in	ID	75.00 mm
3.2520 in	SB	82.60 mm
9.4882 in	BC fix	241.00 mm
9.0157 in	BC min	229.00 mm
9.9606 in	BC max	253.00 mm

Group No. PB 0291 - 1

SLB	UCAK 215
FYH	SL 215
INA	RAKY 75
RHP	SL 75

Group No. PB 0291 - 2

SLB	UELAK 215
FAFNIR	RAK - 75
INA	RAK 75 S
RHP	SL 75 DEC

Figure MU 03

Standard Duty Pillow Blocks - Cast Housing
Eccentric Locking Collar Type, Set Screws Type

2.9528 in	ID	75.00 mm
3.2520 in	SB	82.60 mm
8.5433 in	BC fix	217.00 mm
8.1890 in	BC min	208.00 mm
8.8976 in	BC max	226.00 mm

Group No. PB 0292 - 1

SLB	UCP 215
ASAHI	UCP 215
FAFNIR	RASC - 75
FYH	UCP 215
INA	RASEY 75
LINK - BELT	P 3 - U 2 M 75 N
NACHI	UCP 215
NSK	UCP 215
NTN	UCP 215 D 1
RHP	NP 75
SKF	SY 75 TM
SNR	NP 75

Group No. PB 0292 - 2

SLB	UEL P 215
FAFNIR	RAS - 75
FYH	NAP 215
INA	RASE 75 S
NTN	UEL P 215 D 1 W 3
RHP	NP 75 DEC

Figure MU 07

Medium Duty Pillow Blocks - Cast Housing
Set Screws Type

2.9528 in	ID	75.00 mm
3.5000 in	SB	88.90 mm
9.0157 in	BC fix	229.00 mm
8.7008 in	BC min	221.00 mm
9.3307 in	BC max	237.00 mm

Group No. PB 0293 - 1

SLB	UCP X15
ASAHI	UCP X15

FYH	UCP X15
NSK	UCP X15
NTN	UCP X 15 D 1
RHP	MP 75
SEALMASTER	MP - 315

Figure MU 08

Heavy Duty Pillow Blocks - Cast Housing
Set Screws Type

2.9528 in	ID	75.00 mm
3.9370 in	SB	100.00 mm
11.4173 in	BC fix	290.00 mm
10.7087 in	BC min	272.00 mm
12.1260 in	BC max	308.00 mm

Group No. PB 0294 - 1

SLB	UCP 315
ASAHI	UCP 315
FYH	UCP 315
NSK	UCP 315
NTN	UCP 315 D 1

Figure MU 02

Standard Duty Pillow Blocks - Cast Housing
Eccentric Locking Collar Type, Set Screws Type

3.0000 in	ID	76.20 mm
3.2520 in	SB	82.60 mm
9.4882 in	BC fix	241.00 mm
9.0157 in	BC min	229.00 mm
9.9606 in	BC max	253.00 mm

Group No. PB 0295 - 1

SLB	UCAK 215 - 48
FYH	SL 215 - 48

Figure MU 03

Standard Duty Pillow Blocks - Cast Housing
Eccentric Locking Collar Type, Set Screws Type

3.0000 in	ID	76.20 mm
3.2520 in	SB	82.60 mm
8.5433 in	BC fix	217.00 mm
8.1890 in	BC min	208.00 mm
8.8976 in	BC max	226.00 mm

Group No. PB 0296 - 1

SLB	UCP 215 - 48
ASAHI	UCP 215 - 48
FYH	UCP 215 - 48
LINK - BELT	P 3 - U 2 E 48 N
NACHI	UCP 215 - 48
NSK	UCP 215 - 48 S
NTN	UCP 215 - 300 D 1
RHP	NP 3

Group No. PB 0296 - 2		
SLB	UELP 215 - 48	
FYH	NAP 215 - 48	
NTN	UELP 215 - 300 D 1 W 3	

Figure MU 07		
<i>Medium Duty Pillow Blocks - Cast Housing</i>		
<i>Set Screws Type</i>		
3.0000 in	ID	76.20 mm
3.5000 in	SB	88.90 mm
9.0157 in	BC fix	229.00 mm
8.7008 in	BC min	221.00 mm
9.3307 in	BC max	237.00 mm

Group No. PB 0297 - 1		
SLB	UCP X15 - 48	
ASAHI	UCP X15 - 48	
BROWNING	VPS - 348	
FYH	UCP X15 - 48	
NTN	UCP X15 - 300 D 1	
RHP	MP 3	
SEALMASTER	MP - 48	
SKF	SYM 3 TM	

Figure MU 08		
<i>Heavy Duty Pillow Blocks - Cast Housing</i>		
<i>Set Screws Type</i>		
3.0000 in	ID	76.20 mm
3.9370 in	SB	100.00 mm
11.4173 in	BC fix	290.00 mm
10.7087 in	BC min	272.00 mm
12.1260 in	BC max	308.00 mm

Group No. PB 0298 - 1		
SLB	UCP 315 - 48	
ASAHI	UCP 315 - 48	
FYH	UCP 315 - 48	
NSK	UCP 315 - 48 S	
NTN	UCP 315 - 300 D 1	

Figure MU 03		
<i>Standard Duty Pillow Blocks - Cast Housing</i>		
<i>Eccentric Locking Collar Type, Set Screws Type</i>		
3.0625 in	ID	77.79 mm
3.5000 in	SB	88.90 mm
9.1339 in	BC fix	232.00 mm
8.7402 in	BC min	222.00 mm
9.5276 in	BC max	242.00 mm

Group No. PB 0299 - 1		
SLB	UCP 216 - 49	
NTN	UCP 216 - 301 D 1	

Figure MU 07		
<i>Medium Duty Pillow Blocks - Cast Housing</i>		
<i>Set Screws Type</i>		
3.0625 in	ID	77.79 mm
4.0000 in	SB	101.60 mm
11.1417 in	BC fix	283.00 mm
10.8268 in	BC min	275.00 mm
11.4567 in	BC max	291.00 mm

Group No. PB 0300 - 1		
SLB	UCP X16 - 49	
NTN	UCP X16 - 301 D 1	

Figure MU 08		
<i>Heavy Duty Pillow Blocks - Cast Housing</i>		
<i>Set Screws Type</i>		
3.0625 in	ID	77.79 mm
4.1732 in	SB	106.00 mm
11.8110 in	BC fix	300.00 mm
11.1024 in	BC min	282.00 mm
12.5197 in	BC max	318.00 mm

Group No. PB 0301 - 1		
SLB	UCP 316 - 49	
NTN	UCP 316 - 301 D 1	

Figure MU 03		
<i>Standard Duty Pillow Blocks - Cast Housing</i>		
<i>Eccentric Locking Collar Type, Set Screws Type</i>		
3.1250 in	ID	79.38 mm
3.5000 in	SB	88.90 mm
9.1339 in	BC fix	232.00 mm
8.7402 in	BC min	222.00 mm
9.5276 in	BC max	242.00 mm

Group No. PB 0302 - 1		
SLB	UCP 216 - 50	
ASAHI	UCP 216 - 50	
FYH	UCP 216 - 50	
NACHI	UCP 216 - 50	
NSK	UCP 216 - 50 S	
NTN	UCP 216 - 302 D 1	

Figure MU 07		
<i>Medium Duty Pillow Blocks - Cast Housing</i>		
<i>Set Screws Type</i>		
3.1250 in	ID	79.38 mm
4.0000 in	SB	101.60 mm
11.1417 in	BC fix	283.00 mm
10.8268 in	BC min	275.00 mm
11.4567 in	BC max	291.00 mm

Group No. PB 0303 - 1		
SLB	UCP X16 - 50	
ASAHI	UCP X16 - 50	
NTN	UCP X16 - 302 D 1	

Figure MU 08		
<i>Heavy Duty Pillow Blocks - Cast Housing</i>		
<i>Set Screws Type</i>		
3.1250 in	ID	79.38 mm
4.1732 in	SB	106.00 mm
11.8110 in	BC fix	300.00 mm
11.1024 in	BC min	282.00 mm
12.5197 in	BC max	318.00 mm

Group No. PB 0304 - 1		
SLB	UCP 316 - 50	
ASAHI	UCP 316 - 50	
NSK	UCP 316 - 50 S	
NTN	UCP 316 - 302 D 1	

Figure MU 03		
<i>Standard Duty Pillow Blocks - Cast Housing</i>		
<i>Eccentric Locking Collar Type, Set Screws Type</i>		
3.1496 in	ID	80.00 mm
3.5000 in	SB	88.90 mm
9.1339 in	BC fix	232.00 mm
8.7402 in	BC min	222.00 mm
9.5276 in	BC max	242.00 mm

Group No. PB 0305 - 1		
SLB	UCP 216	
ASAHI	UCP 216	
FYH	UCP 216	
INA	RASEY 80	
NACHI	UCP 216	
NSK	UCP 216	
NTN	UCP 216 D 1	
RHP	NP 80	
SKF	SY 80 TM	
SNR	NP 80	

Figure MU 07		
<i>Medium Duty Pillow Blocks - Cast Housing</i>		
<i>Set Screws Type</i>		
3.1496 in	ID	80.00 mm
4.0000 in	SB	101.60 mm
11.1417 in	BC fix	283.00 mm
10.8268 in	BC min	275.00 mm
11.4567 in	BC max	291.00 mm

Group No. PB 0306 - 1		
SLB	UCP X16	
ASAHI	UCP X16	

FYH	UCP X16
NSK	UCP X16
NTN	UCP X16 D 1
RHP	MP 80
SEALMASTER	MP - 316

Figure MU 08
Heavy Duty Pillow Blocks - Cast Housing
Set Screws Type

3.1496 in	ID	80.00 mm
4.1732 in	SB	106.00 mm
11.8110 in	BC fix	300.00 mm
11.1024 in	BC min	282.00 mm
12.5197 in	BC max	318.00 mm

Group No. PB 0307 - 1

SLB	UCP 316
ASAHI	UCP 316
FYH	UCP 316
NSK	UCP 316
NTN	UCP 316 D 1

Figure MU 03
Standard Duty Pillow Blocks - Cast Housing
Eccentric Locking Collar Type, Set Screws Type

3.1875 in	ID	80.96 mm
3.5000 in	SB	88.90 mm
9.7244 in	BC fix	247.00 mm
9.3307 in	BC min	237.00 mm
10.1181 in	BC max	257.00 mm

Group No. PB 0308 - 1

SLB	UCP 216 - 51
NTN	UCP 216 - 303 D 1

Figure MU 03
Standard Duty Pillow Blocks - Cast Housing
Eccentric Locking Collar Type, Set Screws Type

3.2500 in	ID	82.55 mm
3.7480 in	SB	95.20 mm
9.7244 in	BC fix	247.00 mm
9.3307 in	BC min	237.00 mm
10.1181 in	BC max	257.00 mm

Group No. PB 0309 - 1

SLB	UCP 217 - 52
ASAHI	UCP 217 - 52
FYH	UCP 217 - 52
NACHI	UCP 217 - 52
NSK	UCP 217 - 52 S
NTN	UCP 217 - 304 D 1
RHP	NP 3 1/4

Figure MU 03
Standard Duty Pillow Blocks - Cast Housing
Eccentric Locking Collar Type, Set Screws Type

3.3125 in	ID	84.14 mm
3.7480 in	SB	95.20 mm
9.7244 in	BC fix	247.00 mm
9.3307 in	BC min	237.00 mm
10.1181 in	BC max	257.00 mm

Group No. PB 0310 - 1

SLB	UCP 217 - 53
NTN	UCP 217 - 305 D 1

Figure MU 03
Standard Duty Pillow Blocks - Cast Housing
Eccentric Locking Collar Type, Set Screws Type

3.3465 in	ID	85.00 mm
3.7480 in	SB	95.20 mm
9.7244 in	BC fix	247.00 mm
9.3307 in	BC min	237.00 mm
10.1181 in	BC max	257.00 mm

Group No. PB 0311 - 1

SLB	UCP 217
ASAHI	UCP 217
FYH	UCP 217
LINK - BELT	P 3 - U 2 M 85 N
NACHI	UCP 217
NSK	UCP 217
NTN	UCP 217 D 1
RHP	NP 85
SKF	SY 85 TM

Figure MU 03
Standard Duty Pillow Blocks - Cast Housing
Eccentric Locking Collar Type, Set Screws Type

3.4375 in	ID	87.31 mm
3.7480 in	SB	95.20 mm
9.7244 in	BC fix	247.00 mm
9.3307 in	BC min	237.00 mm
10.1181 in	BC max	257.00 mm

Group No. PB 0312 - 1

SLB	UCP 217 - 55
LINK - BELT	P 3 - U 255 N
NTN	UCP 217 - 307 D 1
RHP	NP 3 7/16

Figure MU 03
Standard Duty Pillow Blocks - Cast Housing
Eccentric Locking Collar Type, Set Screws Type

3.5000 in	ID	88.90 mm
4.0000 in	SB	101.60 mm
10.3150 in	BC fix	262.00 mm
10.0000 in	BC min	254.00 mm
10.6299 in	BC max	270.00 mm

Group No. PB 0313 - 1

SLB	UCP 218 - 56
ASAHI	UCP 218 - 56
FYH	UCP 218 - 56
NACHI	UCP 218 - 56
NSK	UCP 218 - 56 S
NTN	UCP 218 - 308 D 1
RHP	NP 3 1/2
SKF	SY 3 - 1/2 TM

Figure MU 03
Standard Duty Pillow Blocks - Cast Housing
Eccentric Locking Collar Type, Set Screws Type

3.5433 in	ID	90.00 mm
4.0000 in	SB	101.60 mm
10.3150 in	BC fix	262.00 mm
10.0000 in	BC min	254.00 mm
10.6299 in	BC max	270.00 mm

Group No. PB 0314 - 1

SLB	UCP 218
ASAHI	UCP 218
FYH	UCP 218
INA	RASEY 90
NACHI	UCP 218
NSK	UCP 218
NTN	UCP 218 D 1
RHP	NP 90
SKF	SY 90 TM
SNR	NP 90

Figure MU 09

Standard Duty
Two Bolts Flanged Units - Pressed Steel Housing
Eccentric Locking Collar Type, Set Screws Type

0.4724 in	ID	12.00 mm
2.5000 in	SB	63.50 mm

Group No. FU 0001 - 1

SLB	SAPF 201
FYH	SAPF 201
INA	RA 12
NACHI	KHPF 201 AE
NSK	ENPF 201
NTN	AELPF 201 W 3
RHP	SLFE 12 EC

Group No. FU 0001 - 2

SLB	SBPF 201
ASAHI	BPF 1
FYH	SBPF 201
INA	RAY 12
NACHI	BPF 1
NSK	UBPF 201
NTN	ASPF 201

Figure MU 10

Standard Duty
Flanged Cartridge Units - Pressed Steel Housing
Eccentric Locking Collar Type, Set Screws Type

0.4724 in	ID	12.00 mm
2.5000 in	SB	63.50 mm

Group No. FU 0002 - 1

SLB	SAPFL 201
FYH	SAPFL 201
INA	RAT 12
NACHI	KHPFL 201 AE
NSK	ENPFL 201
NTN	AELPFL 201 W 3
RHP	SLFL 12 EC

Group No. FU 0002 - 2

SLB	SBPFL 201
ASAHI	BPFL 1
FYH	SBPFL 201
INA	RATY 12
NACHI	BPFL 1
NSK	UBPFL 201
NTN	ASPFL 201

Figure MU 12

Standard Duty
Flanged Units - Cast Housing
Eccentric Locking Collar Type, Set Screws Type

0.4724 in	ID	12.00 mm
2.5197 in	SB	64.00 mm

Group No. FU 0003 - 1

SLB	UCF 201
ASAHI	UCF 201
FYH	UCF 201
INA	RCJY 12
NACHI	UCF 201
NSK	UCF 201
NTN	UCF 201 D 1

Figure MU 13

Standard Duty
Flanged Cartridge Units - Cast Housing
Eccentric Locking Collar Type, Set Screws Type

0.4724 in	ID	12.00 mm
3.0709 in	SB	78.00 mm

Group No. FU 0004 - 1

SLB	UCFC 201
ASAHI	UCFC 201
FYH	UCFC 201
INA	RMEY 12
NACHI	UCFC 201
NSK	UCFC 201
NTN	UCFC 201 D 1

Figure MU 15

Standard Duty
Two Bolts Flanged Units - Cast Housing
Eccentric Locking Collar Type, Set Screws Type

0.4724 in	ID	12.00 mm
3.5433 in	SB	90.00 mm

Group No. FU 0005 - 1

SLB	UCFL 201
ASAHI	UCFL 201
FYH	UCFL 201
INA	RCJTY 12
NACHI	UCFL 201
NSK	ULFL 201
NTN	UCFL 201 D 1

Figure MU 09

Standard Duty
Two Bolts Flanged Units - Pressed Steel Housing
Eccentric Locking Collar Type, Set Screws Type

0.5000 in	ID	12.70 mm
2.5000 in	SB	63.50 mm

Group No. FU 0006 - 1

SLB	SAPF 201 - 8
FAFNIR	RA - 1/2

FYH	SAPF 201 - 8
INA	RA 1/2"
LINK BELT	40 MSC 1 + 2 B 08
NACHI	KHPF 201 - 8 AE
NTN	AELPF 201 - 008 W 3
RHP	SLFE 1/2 EC
SKF	F 1/2 FM

Group No. FU 0006 - 2

SLB	SBPF 201 - 8
ASAHI	BPF 1 - 8
FYH	SBPF 201 - 8
NACHI	BPF 1 - 8
NTN	ASPF 201 - 008

Figure MU 10

Standard Duty
Flanged Cartridge Units - Pressed Steel Housing
Eccentric Locking Collar Type, Set Screws Type

0.5000 in	ID	12.70 mm
2.5000 in	SB	63.50 mm

Group No. FU 0007 - 1

SLB	SAPFL 201 - 8
FAFNIR	RAT - 1/2
FYH	SAPFL 201 - 8
INA	RAT 1/2"
LINK BELT	40 MST + 2 B 08
NACHI	KHPFL 201 - 8 AE
NTN	AELPFL 201 - 008 W 3
RHP	SLFL 1/2 EC
SKF	FT 1/2 FM

Group No. FU 0007 - 2

SLB	SBPFL 201 - 8
ASAHI	BPFL 1 - 8
FYH	SBPFL 201 - 8
NACHI	BPFL 1 - 8
NTN	ASPFL 201 - 008

Figure MU 12

Standard Duty
Flanged Units - Cast Housing
Eccentric Locking Collar Type, Set Screws Type

0.5000 in	ID	12.70 mm
2.5197 in	SB	64.00 mm

Group No. FU 0008 - 1

SLB	UCF 201 - 8
ASAHI	UCF 201 - 8
FYH	UCF 201 - 8
INA	RCJY 1/2"
NACHI	UCF 201 - 8
NSK	UCF 201 - 8 S
NTN	UCF 201 - 008 D 1
SEALMASTER	SF - 8

Figure MU 13 
 Standard Duty
 Flanged Cartridge Units - Cast Housing
 Eccentric Locking Collar Type, Set Screws Type

0.5000 in	ID	12.70 mm
3.0709 in	SB	78.00 mm

Group No. FU 0009 - 1

SLB	UCFC 201 - 8
ASAHI	UCFC 201 - 8
FYH	UCFC 201 - 8
NACHI	UCFC 201 - 8
NSK	UCFC 201 - 8 S
NTN	UCFC 201 - 008 D 1

Figure MU 15 
 Standard Duty
 Two Bolts Flanged Units - Cast Housing
 Eccentric Locking Collar Type, Set Screws Type

0.5000 in	ID	12.70 mm
3.5433 in	SB	90.00 mm

Group No. FU 0010 - 1

SLB	UCFL 201 - 8
ASAHI	UCFL 201 - 8
FYH	UCFL 201 - 8
INA	RCJTY 1/2"
NACHI	UCFL 201 - 8
NSK	ULFL 201 - 8 S
NTN	UCFL 201 - 008 D 1
SEALMASTER	SFT - 8

Figure MU 09 
 Standard Duty
 Two Bolts Flanged Units - Pressed Steel Housing
 Eccentric Locking Collar Type, Set Screws Type

0.5625 in	ID	14.29 mm
2.5000 in	SB	63.50 mm

Group No. FU 0011 - 1

SLB	SAPF 202 - 9
FAFNIR	RA - 9/16
NACHI	KHPF 202 - 9 AE
NTN	AELPF 202 - 009 W 3

Group No. FU 0011 - 2

SLB	SBPF 202 - 9
ASAHI	BPF 2 - 9
NACHI	BPF 2 - 9
NTN	ASPF 202 - 009

Figure MU 10 
 Standard Duty
 Flanged Cartridge Units - Pressed Steel Housing
 Eccentric Locking Collar Type, Set Screws Type

0.5625 in	ID	14.29 mm
2.5000 in	SB	63.50 mm

Group No. FU 0012 - 1

SLB	SAPFL 202 - 9
NACHI	KHPFL 202 - 9 AE
NTN	AELPFL 202 - 009 W 3

Group No. FU 0012 - 2

SLB	SBPFL 202 - 9
ASAHI	BPFL 2 - 9
NACHI	BPFL 2 - 9
NTN	ASPFL 202 - 009

Figure MU 12 
 Standard Duty
 Flanged Units - Cast Housing
 Eccentric Locking Collar Type, Set Screws Type

0.5625 in	ID	14.29 mm
2.5197 in	SB	64.00 mm

Group No. FU 0013 - 1

SLB	UCF 202 - 9
ASAHI	UCF 202 - 9
NACHI	UCF 202 - 9
NTN	UCF 202 - 009 D 1
SEALMASTER	SF - 9

Figure MU 13 
 Standard Duty
 Flanged Cartridge Units - Cast Housing
 Eccentric Locking Collar Type, Set Screws Type

0.5625 in	ID	14.29 mm
3.0709 in	SB	78.00 mm

Group No. FU 0014 - 1

SLB	UCFC 202 - 9
ASAHI	UCFC 202 - 9
NACHI	UCFC 202 - 9
NTN	UCFC 202 - 009 D 1

Figure MU 15 
 Standard Duty
 Two Bolts Flanged Units - Cast Housing
 Eccentric Locking Collar Type, Set Screws Type

0.5625 in	ID	14.29 mm
3.5433 in	SB	90.00 mm

Group No. FU 0015 - 1

SLB	UCFL 202 - 9
ASAHI	UCFL 202 - 9
NACHI	UCFL 202 - 9
NTN	UCFL 202 - 009 D 1
SEALMASTER	SFT - 9

Figure MU 09 
 Standard Duty
 Two Bolts Flanged Units - Pressed Steel Housing
 Eccentric Locking Collar Type, Set Screws Type

0.5906 in	ID	15.00 mm
2.5000 in	SB	63.50 mm

Group No. FU 0016 - 1

SLB	SAPF 202
FAG	FB 16203/15
FYH	SAPF 202
INA	RA 15
NACHI	KHPF 202 AE
NSK	ENPF 202
NTN	AELPF 202 W 3
RHP	SLFE 15 EC
SKF	F 15 FM

Group No. FU 0016 - 2

SLB	SBPF 202
ASAHI	BPF 2
FYH	SBPF 202
INA	RAY 15
NACHI	BPF 2
NSK	UBPF 202
NTN	ASPF 202

Figure MU 10 
 Standard Duty
 Flanged Cartridge Units - Pressed Steel Housing
 Eccentric Locking Collar Type, Set Screws Type

0.5906 in	ID	15.00 mm
2.5000 in	SB	63.50 mm

Group No. FU 0017 - 1

SLB	SAPFL 202
FYH	SAPFL 202
INA	RAT 15
NACHI	KHPFL 202 AE
NSK	ENPFL 202
NTN	AELPFL 202 W 3
RHP	SLFL 15 EC
SKF	FT 15 FM

Group No. FU 0017 - 2

SLB	SBPFL 202
ASAHI	BPFL 2
FYH	SBPFL 202
INA	RATY 15
NACHI	BPFL 2
NSK	UBPFL 202
NTN	ASPFL 202

Figure MU 12 
 Standard Duty
 Flanged Units - Cast Housing
 Eccentric Locking Collar Type, Set Screws Type

0.5906 in	ID	15.00 mm
2.5197 in	SB	64.00 mm

Group No. FU 0018 - 1

SLB	UCF 202
ASAHI	UCF 202
FYH	UCF 202
INA	RCJY 15
NACHI	UCF 202
NSK	UCF 202
NTN	UCF 202 D 1

Group No. FU 0018 - 2

SLB	UELF 202
INA	RCJ 15

Figure MU 13
Standard Duty
Flanged Cartridge Units - Cast Housing
Eccentric Locking Collar Type, Set Screws Type

0.5906 in	ID	15.00 mm
3.0709 in	SB	78.00 mm

Group No. FU 0019 - 1

SLB	UCFC 202
ASAHI	UCFC 202
FYH	UCFC 202
INA	RMEY 15
NACHI	UCFC 202
NSK	UCFC 202
NTN	UCFC 202 D 1

Group No. FU 0019 - 2

SLB	UELFC 202
INA	RME 15

Figure MU 15
Standard Duty
Two Bolts Flanged Units - Cast Housing
Eccentric Locking Collar Type, Set Screws Type

0.5906 in	ID	15.00 mm
3.5433 in	SB	90.00 mm

Group No. FU 0020 - 1

SLB	UCFL 202
ASAHI	UCFL 202
FYH	UCFL 202
INA	RCJTY 15
NACHI	UCFL 202
NSK	ULFL 202
NTN	UCFL 202 D 1

Group No. FU 0020 - 2

SLB	UELFL 202
INA	RCJT 15

Figure MU 09
Standard Duty
Two Bolts Flanged Units - Pressed Steel Housing
Eccentric Locking Collar Type, Set Screws Type

0.6250 in	ID	15.88 mm
2.5000 in	SB	63.50 mm

Group No. FU 0021 - 1

SLB	SAPF 202 - 10
FAFNIR	RA - 5/8
FYH	SAPF 202 - 10
INA	RA 5/8"
LINK BELT	40 MSC 1 + 210
NACHI	KHPF 202 - 10 AE
NTN	AELPF 202 - 010 W 3
RHP	SLFE 5/8 EC
SKF	F 5/8 FM

Group No. FU 0021 - 2

SLB	SBPF 202 - 10
ASAHI	BPF 2 - 10
FYH	SBPF 202 - 10
NACHI	BPF 2 - 10
NTN	ASPF 202 - 010

Figure MU 10
Standard Duty
Flanged Cartridge Units - Pressed Steel Housing
Eccentric Locking Collar Type, Set Screws Type

0.6250 in	ID	15.88 mm
2.5000 in	SB	63.50 mm

Group No. FU 0022 - 1

SLB	SAPFL 202 - 10
FAFNIR	RAT - 5/8
FYH	SAPFL 202 - 10
INA	RAT 5/8"
KOYO	PTF 010 A
LINK BELT	40 MST + 210
NACHI	KHPFL 202 - 10 AE
NTN	AELPFL 202 - 010 W 3
RHP	SLFL 5/8 EC
SKF	FT 5/8 FM

Group No. FU 0022 - 2

SLB	SBPFL 202 - 10
ASAHI	BPFL 2 - 10
FYH	SBPFL 202 - 10
NACHI	BPFL 2 - 10
NTN	ASPFL 202 - 010

Figure MU 12
Standard Duty
Flanged Units - Cast Housing
Eccentric Locking Collar Type, Set Screws Type

0.6250 in	ID	15.88 mm
2.5197 in	SB	64.00 mm

Group No. FU 0023 - 1

SLB	UCF 202 - 10
ASAHI	UCF 202 - 10
FYH	UCF 202 - 10
INA	RCJY 5/8"
NACHI	UCF 202 - 10
NSK	UCF 202 - 10 S
NTN	UCF 202 - 010 D 1
SEALMASTER	SF - 10

Group No. FU 0023 - 2

SLB	UELF 202 - 10
INA	RCJ 5/8"

Figure MU 13
Standard Duty
Flanged Cartridge Units - Cast Housing
Eccentric Locking Collar Type, Set Screws Type

0.6250 in	ID	15.88 mm
3.0709 in	SB	78.00 mm

Group No. FU 0024 - 1

SLB	UCFC 202 - 10
ASAHI	UCFC 202 - 10
FYH	UCFC 202 - 10
NACHI	UCFC 202 - 10
NSK	UCFC 202 - 10 S
NTN	UCFC 202 - 010 D 1

Figure MU 15
Standard Duty
Two Bolts Flanged Units - Cast Housing
Eccentric Locking Collar Type, Set Screws Type

0.6250 in	ID	15.88 mm
3.5433 in	SB	90.00 mm

Group No. FU 0025 - 1

SLB	UCFL 202 - 10
ASAHI	UCFL 202 - 10
FYH	UCFL 202 - 10
INA	RCJTY 5/8"
NACHI	UCFL 202 - 10
NSK	ULFL 202 - 10 S
NTN	UCFL 202 - 010 D 1
SEALMASTER	SFT - 10

Group No. FU 0025 - 2

SLB	UELFL 202 - 10
INA	RCJT 5/8"

Figure MU 09 
Standard Duty
Two Bolts Flanged Units - Pressed Steel Housing
Eccentric Locking Collar Type, Set Screws Type

0.6693 in	ID	17.00 mm
2.5000 in	SB	63.50 mm

Group No. FU 0026 - 1

SLB	SAPF 203
FAFNIR	RA - 17
FAG	FB 16203
FYH	SAPF 203
INA	RA 17
LINK BELT	40 MSC 1 + 2 M 17
NACHI	KHPF 203 AE
NSK	ENPF 203
NTN	AELPF 203 W 3
RHP	SLFE 17 EC
SKF	F 17 FM
SNR	40 MSA + 1217 - 17 ECG

Group No. FU 0026 - 2

SLB	SBPF 203
ASAHI	BPF 3
FYH	SBPF 203
INA	RAY 17
NACHI	BPF 3
NSK	UBPF 203
NTN	ASPF 203

Figure MU 10 
Standard Duty
Flanged Cartridge Units - Pressed Steel Housing
Eccentric Locking Collar Type, Set Screws Type

0.6693 in	ID	17.00 mm
2.5000 in	SB	63.50 mm

Group No. FU 0027 - 1

SLB	SAPFL 203
FAFNIR	RAT - 17
FYH	SAPFL 203
INA	RAT 17
KOYO	PTF 011 MA
LINK BELT	40 MST + 2 M 17
NACHI	KHPFL 203 AE
NSK	ENPFL 203
NTN	AELPFL 203 W 3
RHP	SLFL 17 EC
SKF	FT 17 FM
SNR	40 MLA + 1217 - 17 ECG

Group No. FU 0027 - 2

SLB	SBPFL 203
ASAHI	BPFL 3
FYH	SBPFL 203
INA	RATY 17

NACHI	BPFL 3
NSK	UBPFL 203
NTN	ASPF 203

Figure MU 12 
Standard Duty
Flanged Units - Cast Housing
Eccentric Locking Collar Type, Set Screws Type

0.6693 in	ID	17.00 mm
2.5197 in	SB	64.00 mm

Group No. FU 0028 - 1

SLB	UCF 203
ASAHI	UCF 203
FYH	UCF 203
INA	RCJY 17
NACHI	UCF 203
NSK	UCF 203
NTN	UCF 203 D 1

Group No. FU 0028 - 2

SLB	UELF 203
INA	RCJ 17

Figure MU 13 
Standard Duty
Flanged Cartridge Units - Cast Housing
Eccentric Locking Collar Type, Set Screws Type

0.6693 in	ID	17.00 mm
3.0709 in	SB	78.00 mm

Group No. FU 0029 - 1

SLB	UCFC 203
ASAHI	UCFC 203
FYH	UCFC 203
INA	RMEY 17
NACHI	UCFC 203
NSK	UCFC 203
NTN	UCFC 203 D 1

Group No. FU 0029 - 2

SLB	UELFC 203
INA	RME 17

Figure MU 15 
Standard Duty
Two Bolts Flanged Units - Cast Housing
Eccentric Locking Collar Type, Set Screws Type

0.6693 in	ID	17.00 mm
3.5433 in	SB	90.00 mm

Group No. FU 0030 - 1

SLB	UCFL 203
ASAHI	UCFL 203

FYH	UCFL 203
INA	RCJTY 17
NACHI	UCFL 203
NSK	ULFL 203
NTN	UCFL 203 D 1

Group No. FU 0030 - 2

SLB	UELFL 203
INA	RCJT 17

Figure MU 09 
Standard Duty
Two Bolts Flanged Units - Pressed Steel Housing
Eccentric Locking Collar Type, Set Screws Type

0.6875 in	ID	17.46 mm
2.5000 in	SB	63.50 mm

Group No. FU 0031 - 1

SLB	SAPF 203 - 11
LINK BELT	40 MSC 1 + 211
NACHI	KHPF 203 - 11 AE
NTN	AELPF 203 - 011 W 3
SKF	F 11/16 FM

Group No. FU 0031 - 2

SLB	SBPF 203 - 11
ASAHI	BPF 3 - 11
NACHI	BPF 3 - 11
NTN	ASPF 203 - 011

Figure MU 10 
Standard Duty
Flanged Cartridge Units - Pressed Steel Housing
Eccentric Locking Collar Type, Set Screws Type

0.6875 in	ID	17.46 mm
2.5000 in	SB	63.50 mm

Group No. FU 0032 - 1

SLB	SAPFL 203 - 11
LINK BELT	40 MST + 211
NACHI	KHPFL 203 - 11 AE
NTN	AELPFL 203 - 011 W 3
SKF	FT 11/16 FM

Group No. FU 0032 - 2

SLB	SBPFL 203 - 11
ASAHI	BPFL 3 - 11
NACHI	BPFL 3 - 11
NTN	ASPF 203 - 011

Figure MU 12 
Standard Duty
Flanged Units - Cast Housing
Eccentric Locking Collar Type, Set Screws Type

0.6875 in	ID	17.46 mm
2.5197 in	SB	64.00 mm
Group No. FU 0033 - 1		
SLB	UCF 203 - 11	
ASAHI	UCF 203 - 11	
NACHI	UCF 203 - 11	
NTN	UCF 203 - 011 D 1	
SEALMASTER	SF - 11	

Figure MU 13 

Standard Duty
Flanged Cartridge Units - Cast Housing
Eccentric Locking Collar Type, Set Screws Type

0.6875 in	ID	17.46 mm
3.0709 in	SB	78.00 mm
Group No. FU 0034 - 1		
SLB	UCFC 203 - 11	
ASAHI	UCFC 203 - 11	
NACHI	UCFC 203 - 11	
NTN	UCFC 203 - 011 D 1	

Figure MU 15 

Standard Duty
Two Bolts Flanged Units - Cast Housing
Eccentric Locking Collar Type, Set Screws Type

0.6875 in	ID	17.46 mm
3.5433 in	SB	90.00 mm
Group No. FU 0035 - 1		
SLB	UCFL 203 - 11	
ASAHI	UCFL 203 - 11	
NACHI	UCFL 203 - 11	
NTN	UCFL 203 - 011 D 1	
SEALMASTER	SFT - 11	

Figure MU 11 

Standard Duty
Flanged Units - Cast Housing
Eccentric Locking Collar Type, Set Screws Type

0.7500 in	ID	19.05 mm
2.5000 in	SB	63.50 mm
Group No. FU 0036 - 1		
SLB	UCFS 204 - 12	
ASAHI	UCLF 204 - 12	
FYH	SLF 204 - 12	
LINK BELT	F 3 - U 212 N	
RHP	SF 3/4	
Group No. FU 0036 - 2		
SLB	UELFS 204 - 12	
BROWNING	VF 4 E - 212	

FAFNIR	RCJ - 3/4
LINK BELT	F 3 - Y 212 N
NTN	UELFU 204 - 012 D 1 W 3
RHP	SF 3/4 DEC
Group No. FU 0036 - 3	
SLB	SAFS 204 - 12
FAFNIR	VCJ - 3/4
LINK BELT	F 3 - W 212 U
RHP	SF 3/4 EC
Group No. FU 0036 - 4	
SLB	SBFS 204 - 12
LINK BELT	F 3 - S 212 E
RHP	SF 3/4 A

Figure MU 12 

Standard Duty
Flanged Units - Cast Housing
Eccentric Locking Collar Type, Set Screws Type

0.7500 in	ID	19.05 mm
2.5197 in	SB	64.00 mm

Group No. FU 0037 - 1

SLB	UCF 204 - 12
ASAHI	UCF 204 - 12
BROWNING	VF 4 S - 212
FAG	FG 56204.012
FYH	UCF 204 - 12
INA	RCJY 3/4"
KOYO	UCF 204 - 12
NACHI	UCF 204 - 12
NSK	UCF 204 - 12 S
NTN	UCF 204 - 012 D 1
SEALMASTER	SF - 12
SKF	FY 3/4 TM

Group No. FU 0037 - 2

SLB	UELF 204 - 12
INA	RCJ 3/4"
KOYO	GFF 1012 B
NACHI	UGF 204 - 12 + ER
NTN	UELF 204 - 012 D 1 W 3
SKF	FY 3/4 WM

Group No. FU 0037 - 3

SLB	SAF 204 - 12
BROWNING	VF 4 E - 112
FAG	FG 16204.012
INA	PCJ 3/4"
KOYO	GARAF 012 A
SKF	FY 3/4 FM

Group No. FU 0037 - 4

SLB	SBF 204 - 12
ASAHI	BF 204 - 12
BROWNING	VF 4 S - 112
NACHI	BF 204 - 12

Figure MU 09 

Standard Duty
Two Bolts Flanged Units - Pressed Steel Housing
Eccentric Locking Collar Type, Set Screws Type

0.7500 in	ID	19.05 mm
2.8150 in	SB	71.50 mm

Group No. FU 0038 - 1

SLB	SAPF 204 - 12
FAFNIR	RA - 3/4
FAG	FB 16204.012
FYH	SAPF 204 - 12
INA	RA 3/4"
KOYO	PF 012 A
LINK BELT	47 MSC 1 + 212
NACHI	KHPF 204 - 12 AE
NTN	AELPF 204 - 012 W 3
RHP	SLFE 3/4 EC
SKF	F 3/4 FM

Group No. FU 0038 - 2

SLB	SBPF 204 - 12
ASAHI	BPF 4 - 12
FYH	SBPF 204 - 12
NACHI	BPF 4 - 12
NTN	ASPF 204 - 012
RHP	SLFE 3/4 A

Figure MU 10 

Standard Duty
Flanged Cartridge Units - Pressed Steel Housing
Eccentric Locking Collar Type, Set Screws Type

0.7500 in	ID	19.05 mm
2.8150 in	SB	71.50 mm

Group No. FU 0039 - 1

SLB	SAPFL 204 - 12
FAFNIR	RAT - 3/4
FYH	SAPFL 204 - 12
INA	RAT 3/4"
KOYO	PTF 012 A
LINK BELT	47 MST + 212
NACHI	KHPFL 204 - 12 AE
NTN	AELPFL 204 - 012 W 3
RHP	SLFL 3/4 EC
SKF	FT 3/4 FM

Group No. FU 0039 - 2

SLB	SBPFL 204 - 12
ASAHI	BPFL 4 - 12
FYH	SBPFL 204 - 12
NACHI	BPFL 4 - 12
NTN	ASPFL 204 - 012
RHP	SLFL 3/4 A

Figure MU 13 

Standard Duty
Flanged Cartridge Units - Cast Housing
Eccentric Locking Collar Type, Set Screws Type

0.7500 in	ID	19.05 mm
3.0709 in	SB	78.00 mm

Group No. FU 0040 - 1

SLB	UCFC 204 - 12
ASAHI	UCFC 204 - 12
FYH	UCFC 204 - 12
INA	RMEY 3/4"
NACHI	UCFC 204 - 12
NSK	UCFC 204 - 12 S
NTN	UCFC 204 - 012 D 1
RHP	FC 3/4

Group No. FU 0040 - 2

SLB	UELFC 204 - 12
NACHI	UGFC 204 - 12 + ER
NTN	UELFC 204 - 012 D 1 W 3
RHP	FC 3/4 DEC

Group No. FU 0040 - 3

SLB	SAFC 204 - 12
RHP	FC 3/4 EC

Group No. FU 0040 - 4

SLB	SBFC 204 - 12
NACHI	BFC 204 - 12
RHP	FC 3/4 A

Figure MU 14 

Standard Duty
Two Bolts Flanged Units - Cast Housing
Eccentric Locking Collar Type, Set Screws Type

0.7500 in	ID	19.05 mm
3.5433 in	SB	90.00 mm

Group No. FU 0041 - 1

SLB	UCFT 204 - 12
ASAHI	UCFT 204 - 12
LINK BELT	FX 3 - U 212 N
RHP	SFT 3/4

Group No. FU 0041 - 2

SLB	UELFT 204 - 12
BROWNING	VF 2 E - 212
LINK BELT	FX 3 - Y 212 N
NTN	UELFLU 204 - 012 D 1 W 3
RHP	SFT 3/4 DEC

Group No. FU 0041 - 3

SLB	SAFT 204 - 12
FAFNIR	VCJT - 3/4
LINK BELT	FX 3 - W 212 U
RHP	SFT 3/4 EC

Group No. FU 0041 - 4

SLB	SBFT 204 - 12
FAFNIR	SCJT - 3/4
LINK BELT	FX 3 - S 212 E
RHP	SFT 3/4 A

Figure MU 15 

Standard Duty
Two Bolts Flanged Units - Cast Housing
Eccentric Locking Collar Type, Set Screws Type

0.7500 in	ID	19.05 mm
3.5433 in	SB	90.00 mm

Group No. FU 0042 - 1

SLB	UCFL 204 - 12
ASAHI	UCFL 204 - 12
BROWNING	VF 2 S - 212
FYH	UCFL 204 - 12
INA	RCJTY 3/4"
KOYO	UCFL 204 - 12
NACHI	UCFL 204 - 12
NSK	ULFL 204 - 12 S
NTN	UCFL 204 - 012 D 1
SEALMASTER	SFT - 12
SKF	FYT 3/4 TM

Group No. FU 0042 - 2

SLB	UELFL 204 - 12
FAFNIR	RCJT - 3/4
INA	RCJT 3/4"
KOYO	GFFL 1012 B
NACHI	UGFL 204 - 12 + ER
NTN	UELFL 204 - 012 D 1 W 3
SKF	FYT 3/4 WM

Group No. FU 0042 - 3

SLB	SAFL 204 - 12
BROWNING	VF 2 E - 112
INA	PCJT 3/4"
KOYO	GARAF 012 A
SKF	FYT 3/4 FM

Group No. FU 0042 - 4

SLB	SBFL 204 - 12
ASAHI	BFL 204 - 12
BROWNING	VF 2 S - 112
NACHI	BFL 204 - 12

Figure MU 11 

Standard Duty
Flanged Units - Cast Housing
Eccentric Locking Collar Type, Set Screws Type

0.7874 in	ID	20.00 mm
2.5000 in	SB	63.50 mm

Group No. FU 0043 - 1

SLB	UCFS 204
ASAHI	UCLF 204
FYH	SLF 204
LINK BELT	F 3 - U 2 M 20 N
RHP	SF 20
SNR	SF 20

Group No. FU 0043 - 2

SLB	UELFS 204
FAFNIR	RCJ - 20
NTN	UELFU 204 D 1 W 3
RHP	SF 20 DEC

Group No. FU 0043 - 3

SLB	SAFS 204
FAFNIR	VCJ - 20
RHP	SF 20 EC
SNR	SF 20 EC

Group No. FU 0043 - 4

SLB	SBFS 204
RHP	SF 20 A
SNR	SF 20 A

Figure MU 12 

Standard Duty
Flanged Units - Cast Housing
Eccentric Locking Collar Type, Set Screws Type

0.7874 in	ID	20.00 mm
2.5197 in	SB	64.00 mm

Group No. FU 0044 - 1

SLB	UCF 204
ASAHI	UCF 204
FAG	FG 56204
FYH	UCF 204
INA	RCJY 20
KOYO	UCF 204
NACHI	UCF 204
NSK	UCF 204
NTN	UCF 204 D 1
SEALMASTER	SF - 204
SKF	FY 20 TM

Group No. FU 0044 - 2

SLB	UELFL 204
INA	RCJ 20
KOYO	GFF 1012 MB
NACHI	UGF 204 + ER
NSK	EFW 204
NTN	UELFL 204 D 1 W 3
SKF	FY 20 WM

Group No. FU 0044 - 3

SLB	SAF 204
FAG	FG 16204
INA	PCJ 20

KOYO	GARAF 012 MA
SKF	FY 20 FM
Group No. FU 0044 - 4	
SLB	SBF 204
ASAHI	BF 204
INA	PCJY 20
NACHI	BF 204
NSK	UBF 204 J

Figure MU 16 

Standard Duty
Flanged Units - Cast Housing
Adapter Type

0.7874 in	ID	20.00 mm
2.7559 in	SB	70.00 mm
Group No. FU 0045 - 1		
SLB	UKF 205	
ASAHI	UKF 205	
FYH	UKF 205	
NACHI	UKF 205	
NSK	UKF 205	
NTN	UKF 205 D 1	

Figure MU 09 

Standard Duty
Two Bolts Flanged Units - Pressed Steel Housing
Eccentric Locking Collar Type, Set Screws Type

0.7874 in	ID	20.00 mm
2.8150 in	SB	71.50 mm
Group No. FU 0046 - 1		
SLB	SAPF 204	
FAFNIR	RA - 20	
FAG	FB 16204	
FYH	SAPF 204	
INA	RA 20	
KOYO	PF 012 MA	
LINK BELT	47 MSC 1 + 2 M 20	
NACHI	KHPF 204 AE	
NSK	ENPF 204	
NTN	AELPF 204 W 3	
RHP	SLFE 20 EC	
SKF	F 20 FM	
SNR	47 MSA + 1220 - 20 ECG	
Group No. FU 0046 - 2		
SLB	SBPF 204	
ASAHI	BPF 4	
FYH	SBPF 204	
INA	RAY 20	
NACHI	BPF 4	
NSK	UBPF 204	
NTN	ASPF 204	
RHP	SLFE 20 A	
SNR	47 MSA + 1220 - 20 G	

Figure MU 10 

Standard Duty
Flanged Cartridge Units - Pressed Steel Housing
Eccentric Locking Collar Type, Set Screws Type

0.7874 in	ID	20.00 mm
2.8150 in	SB	71.50 mm
Group No. FU 0047 - 1		
SLB	SAPFL 204	
FAFNIR	RAT - 20	
FYH	SAPFL 204	
INA	RAT 20	
KOYO	PTF 012 MA	
LINK BELT	47 MST + 2 M 20	
NACHI	KHPFL 204 AE	
NSK	ENPFL 204	
NTN	AELPFL 204 W 3	
RHP	SLFL 20 EC	
SKF	FT 20 FM	
SNR	47 MLA + 1220 - 20 ECG	
Group No. FU 0047 - 2		
SLB	SBPFL 204	
ASAHI	BPFL 4	
FYH	SBPFL 204	
INA	RATY 20	
NACHI	BPFL 4	
NSK	UBPFL 204	
NTN	ASPFL 204	
RHP	SLFL 20 A	
SNR	47 MLA + 1220 - 20 G	

Figure MU 13 

Standard Duty
Flanged Cartridge Units - Cast Housing
Eccentric Locking Collar Type, Set Screws Type

0.7874 in	ID	20.00 mm
3.0709 in	SB	78.00 mm
Group No. FU 0048 - 1		
SLB	UCFC 204	
ASAHI	UCFC 204	
FYH	UCFC 204	
INA	RMEY 20	
NACHI	UCFC 204	
NSK	UCFC 204	
NTN	UCFC 204 D 1	
RHP	FC 20	
Group No. FU 0048 - 2		
SLB	UELFC 204	
INA	RME 20	
NACHI	UGFC 204 + ER	
NSK	EWFC 204	
NTN	UELFC 204 D 1 W 3	
RHP	FC 20 DEC	

Group No. FU 0048 - 3

SLB	SAFC 204
INA	PME 20
RHP	FC 20 EC
Group No. FU 0048 - 4	
SLB	SBFC 204
NACHI	BFC 204
NSK	UBFC 204 J
RHP	FC 20 A

Figure MU 14 

Standard Duty
Two Bolts Flanged Units - Cast Housing
Eccentric Locking Collar Type, Set Screws Type

0.7874 in	ID	20.00 mm
3.5433 in	SB	90.00 mm
Group No. FU 0049 - 1		
SLB	UCFT 204	
ASAHI	UCFT 204	
LINK BELT	FX 3 - U 2 M 20 N	
RHP	SFT 20	
SNR	SFT 20	

Group No. FU 0049 - 2

SLB	UELFT 204
NTN	UELFLU 204 D 1 W 3
RHP	SFT 20 DEC
Group No. FU 0049 - 3	
SLB	SAFT 204
FAFNIR	VCJT - 20
RHP	SFT 20 EC
SNR	SFT 20 EC
Group No. FU 0049 - 4	
SLB	SBFT 204
FAFNIR	SCJT - 20
RHP	SFT 20 A
SNR	SFT 20 A

Figure MU 15 

Standard Duty
Two Bolts Flanged Units - Cast Housing
Eccentric Locking Collar Type, Set Screws Type

0.7874 in	ID	20.00 mm
3.5433 in	SB	90.00 mm
Group No. FU 0050 - 1		
SLB	UCFL 204	
ASAHI	UCFL 204	
FYH	UCFL 204	
INA	RCJTY 20	
KOYO	UCFL 204	

NACHI	UCFL 204
NSK	ULFL 204
NTN	UCFL 204 D 1
SEALMASTER	SFT - 204
SKF	FYT 20 TM

Group No. FU 0050 - 2

SLB	UELFL 204
FAFNIR	RCJT - 20
INA	RCJT 20
KOYO	GFFL 1012 MB
NACHI	UGFL 204 + ER
NSK	EWFL 204
NTN	UELFL 204 D 1 W 3
SKF	FYT 20 WM

Group No. FU 0050 - 3

SLB	SAFL 204
INA	PCJT 20
KOYO	GARAFL 012 MA
SKF	FYT 20 FM

Group No. FU 0050 - 4

SLB	SBFL 204
ASAHI	BFL 204
INA	PCJTY 20
NACHI	BFL 204
NSK	UBFL 204 J

Figure MU 17

Standard Duty
Flanged Cartridge Units - Cast Housing
Adapter Type

0.7874 in	ID	20.00 mm
3.5433 in	SB	90.00 mm

Group No. FU 0051 - 1

SLB	UKFC 205
FYH	UKFC 205
NACHI	UKFC 205
NSK	UKFC 205
NTN	UKFC 205 D 1

Figure MU 18

Standard Duty
Two Bolts Flanged Units - Cast Housing
Adapter Type

0.7874 in	ID	20.00 mm
3.8976 in	SB	99.00 mm

Group No. FU 0052 - 1

SLB	UKFL 205
FYH	UKFL 205
NACHI	UKFL 205
NSK	UKFL 205
NTN	UKFL 205 D 1

Figure MU 12

Standard Duty
Flanged Units - Cast Housing
Eccentric Locking Collar Type, Set Screws Type

0.8125 in	ID	20.64 mm
2.7559 in	SB	70.00 mm

Group No. FU 0053 - 1

SLB	UCF 205 - 13
KOYO	UCF 205 - 13
NTN	UCF 205 - 013 D 1
SEALMASTER	SF - 13
SKF	FY 13/16 TM

Group No. FU 0053 - 2

SLB	UELF 205 - 13
KOYO	GFF 1013 B
NTN	UELF 205 - 013 D 1 W 3
SKF	FY 13/16 WM

Group No. FU 0053 - 3

SLB	SAF 205 - 13
KOYO	GARAF 013 A
SKF	FY 13/16 FM

Figure MU 09

Standard Duty
Two Bolts Flanged Units - Pressed Steel Housing
Eccentric Locking Collar Type, Set Screws Type

0.8125 in	ID	20.64 mm
2.9921 in	SB	76.00 mm

Group No. FU 0054 - 1

SLB	SAPF 205 - 13
FAFNIR	RA - 13/16
KOYO	PF 013 A
NTN	AELPF 205 - 013 W 3
SKF	F 13/16 FM

Group No. FU 0054 - 2

SLB	SBPF 205 - 13
NTN	ASPF 205 - 013

Figure MU 10

Standard Duty
Flanged Cartridge Units - Pressed Steel Housing
Eccentric Locking Collar Type, Set Screws Type

0.8125 in	ID	20.64 mm
2.9921 in	SB	76.00 mm

Group No. FU 0055 - 1

SLB	SAPFL 205 - 13
KOYO	PTF 013 A
NTN	AELPFL 205 - 013 W 3
SKF	FT 13/16 FM

Group No. FU 0055 - 2

SLB	SBPFL 205 - 13
NTN	ASPFL 205 - 013

Figure MU 21

Heavy Duty
Flanged Units - Cast Housing
Set Screws Type

0.8125 in	ID	20.64 mm
3.1496 in	SB	80.00 mm

Group No. FU 0056 - 1

SLB	UCF 305 - 13
NTN	UCF 305 - 013 D 1

Figure MU 19

Medium Duty
Flanged Units - Cast Housing
Set Screws Type

0.8125 in	ID	20.64 mm
3.2480 in	SB	82.50 mm

Group No. FU 0057 - 1

SLB	UCF X05 - 13
NTN	UCF X05 - 013 D 1

Figure MU 13

Standard Duty
Flanged Cartridge Units - Cast Housing
Eccentric Locking Collar Type, Set Screws Type

0.8125 in	ID	20.64 mm
3.5433 in	SB	90.00 mm

Group No. FU 0058 - 1

SLB	UCFC 205 - 13
NTN	UCFC 205 - 013 D 1

Group No. FU 0058 - 2

SLB	UELFC 205 - 13
NTN	UELFC 205 - 013 D 1 W 3

Figure MU 14

Standard Duty
Two Bolts Flanged Units - Cast Housing
Eccentric Locking Collar Type, Set Screws Type

0.8125 in	ID	20.64 mm
3.8976 in	SB	99.00 mm

Group No. FU 0059 - 1

SLB	UCFT 205 - 13
FYH	UCFT 205 - 13

Group No. FU 0059 - 2	
SLB	UELFT 205 - 13
NTN	UELFLU 205 - 013 D 1 W 3
Group No. FU 0059 - 3	
SLB	SAFT 205 - 13
FAFNIR	VCJT - 13/16

Figure MU 15		
<i>Standard Duty</i>		
<i>Two Bolts Flanged Units - Cast Housing</i>		
<i>Eccentric Locking Collar Type, Set Screws Type</i>		
0.8125 in	ID	20.64 mm
3.8976 in	SB	99.00 mm

Group No. FU 0060 - 1	
SLB	UCFL 205 - 13
KOYO	UCFL 205 - 13 B
NTN	UCFL 205 - 013 D 1
SEALMASTER	SFT - 13
SKF	FYT 13/16 TM

Group No. FU 0060 - 2	
SLB	UELFL 205 - 13
FAFNIR	RCJT - 13/16
KOYO	GFFL 1013 B
NTN	UELFL 205 - 013 D 1 W 3
SKF	FYT 13/16 WM

Group No. FU 0060 - 3	
SLB	SAFL 205 - 13
KOYO	GARAF 013 BA
SKF	FYT 13/16 FM

Figure MU 22		
<i>Heavy Duty</i>		
<i>Two Bolts Flanged Units - Cast Housing</i>		
<i>Set Screws Type</i>		
0.8125 in	ID	20.64 mm
4.4488 in	SB	113.00 mm

Group No. FU 0061 - 1	
SLB	UCFL 305 - 13
NTN	UCFL 305 - 013 D 1

Figure MU 20		
<i>Medium Duty</i>		
<i>Two Bolts Flanged Units - Cast Housing</i>		
<i>Set Screws Type</i>		
0.8125 in	ID	20.64 mm
4.6063 in	SB	117.00 mm

Group No. FU 0062 - 1	
SLB	UCFL X05 - 13
NTN	UCFL X05 - 013 D 1

Figure MU 11		
<i>Standard Duty</i>		
<i>Flanged Units - Cast Housing</i>		
<i>Eccentric Locking Collar Type, Set Screws Type</i>		
0.8125 in	ID	20.64 mm
2.7559 in	SB	70.0 mm

Group No. FU 0063 - 1	
SLB	UCFS 205 - 13
FYH	UCFS 205 - 13

Group No. FU 0063 - 2	
SLB	UELFS 205 - 13
FAFNIR	RCJ - 13/16
NTN	UELFLU 205 - 013 D 1 W 3

Group No. FU 0063 - 3	
SLB	SAFS 205 - 13
FAFNIR	VCJ - 13/16

Figure MU 12		
<i>Standard Duty</i>		
<i>Flanged Units - Cast Housing</i>		
<i>Eccentric Locking Collar Type, Set Screws Type</i>		
0.8750 in	ID	22.23 mm
2.7559 in	SB	70.00 mm

Group No. FU 0064 - 1	
SLB	UCF 205 - 14
ASAHI	UCF 205 - 14
BROWNING	VF 4 S - 214
FYH	UCF 205 - 14
INA	RCJY 7/8"
KOYO	UCF 205 - 14
NACHI	UCF 205 - 14
NSK	UCF 205 - 14 S
NTN	UCF 205 - 014 D 1
SEALMASTER	SF - 14
SKF	FY 7/8 TM

Group No. FU 0064 - 2	
SLB	UELF 205 - 14
INA	RCJ 7/8"
KOYO	GFF 1014 B
NACHI	UGF 205 - 14 + ER
NTN	UELF 205 - 014 D 1 W 3
SKF	FY 7/8 WM

Group No. FU 0064 - 3	
SLB	SAF 205 - 14
BROWNING	VF 4 E - 114
FAG	FG 16205.014
INA	PCJ 7/8"
KOYO	GARAF 014 A
SKF	FY 7/8 FM

Group No. FU 0064 - 4	
SLB	SBF 205 - 14
ASAHI	BF 205 - 14
BROWNING	VF 4 S - 114
NACHI	BF 205 - 14

Figure MU 09		
<i>Standard Duty</i>		
<i>Two Bolts Flanged Units - Pressed Steel Housing</i>		
<i>Eccentric Locking Collar Type, Set Screws Type</i>		
0.8750 in	ID	22.23 mm
2.9921 in	SB	76.00 mm

Group No. FU 0065 - 1	
SLB	SAPF 205 - 14
FAFNIR	RA - 7/8
FAG	FB 16205.014
FYH	SAPF 205 - 14
INA	RA 7/8"
KOYO	PF 014 A
LINK BELT	52 MSC 1 + 214
NACHI	KHPF 205 - 14 AE
NTN	AELPF 205 - 014 W 3
RHP	SLFE 7/8 EC
SKF	F 7/8 FM

Group No. FU 0065 - 2	
SLB	SBPF 205 - 14
ASAHI	BPF 5 - 14
FYH	SBPF 205 - 14
NACHI	BPF 5 - 14
NTN	ASPF 205 - 014

Figure MU 10		
<i>Standard Duty</i>		
<i>Flanged Cartridge Units - Pressed Steel Housing</i>		
<i>Eccentric Locking Collar Type, Set Screws Type</i>		
0.8750 in	ID	22.23 mm
2.9921 in	SB	76.00 mm

Group No. FU 0066 - 1	
SLB	SAPFL 205 - 14
FAFNIR	RAT - 7/8
FYH	SAPFL 205 - 14
INA	RAT 7/8"
KOYO	PTF 014 A
LINK BELT	52 MST + 214
NACHI	KHPFL 205 - 14 AE
NTN	AELPFL 205 - 014 W 3
RHP	SLFL 7/8 EC
SKF	FT 7/8 FM

Group No. FU 0066 - 2	
SLB	SBPFL 205 - 14
ASAHI	BPFL 5 - 14

FYH	SBPFL 205 - 14
NACHI	BPFL 5 - 14
NTN	ASPFL 205 - 014

Figure MU 21 
Heavy Duty
Flanged Units - Cast Housing
Set Screws Type

0.8750 in	ID	22.23 mm
3.1496 in	SB	80.00 mm

Group No. FU 0067 - 1

SLB	UCF 305 - 14
ASAHI	UCF 305 - 14
NSK	UCF 305 - 14 S
NTN	UCF 305 - 014 D 1

Figure MU 19 
Medium Duty
Flanged Units - Cast Housing
Set Screws Type

0.8750 in	ID	22.23 mm
3.2480 in	SB	82.50 mm

Group No. FU 0068 - 1

SLB	UCF X05 - 14
ASAHI	UCF X05 - 14
NTN	UCF X05 - 014 D 1

Figure MU 13 
Standard Duty
Flanged Cartridge Units - Cast Housing
Eccentric Locking Collar Type, Set Screws Type

0.8750 in	ID	22.23 mm
3.5433 in	SB	90.00 mm

Group No. FU 0069 - 1

SLB	UCFC 205 - 14
ASAHI	UCFC 205 - 14
FYH	UCFC 205 - 14
INA	RMEY 7/8"
NACHI	UCFC 205 - 14
NSK	UCFC 205 - 14 S
NTN	UCFC 205 - 014 D 1
RHP	FC 7/8

Group No. FU 0069 - 2

SLB	UELFC 205 - 14
NACHI	UGFC 205 - 14 + ER
NTN	UELFC 205 - 014 D 1 W 3
RHP	FC 7/8 DEC

Group No. FU 0069 - 3

SLB	SAFC 205 - 14
RHP	FC 7/8 EC

Group No. FU 0069 - 4

SLB	SBFC 205 - 14
NACHI	BFC 205 - 14

Figure MU 14 
Standard Duty
Two Bolts Flanged Units - Cast Housing
Eccentric Locking Collar Type, Set Screws Type

0.8750 in	ID	22.23 mm
3.8976 in	SB	99.00 mm

Group No. FU 0070 - 1

SLB	UCFT 205 - 14
ASAHI	UCFT 205 - 14
LINK BELT	FX 3 - U 214 N
RHP	SFT 7/8

Group No. FU 0070 - 2

SLB	UELFT 205 - 14
BROWNING	VF 2 E - 214
LINK BELT	FX 3 - Y 214 N
NTN	UELFLU 205 - 014 D 1 W 3
RHP	SFT 7/8 DEC

Group No. FU 0070 - 3

SLB	SAFT 205 - 14
FAFNIR	VCJT - 7/8
LINK BELT	FX 3 - W 214 U
RHP	SFT 7/8 EC

Group No. FU 0070 - 4

SLB	SBFT 205 - 14
FAFNIR	SCJT - 7/8
LINK BELT	FX 3 - S 214 E

Figure MU 15 
Standard Duty
Two Bolts Flanged Units - Cast Housing
Eccentric Locking Collar Type, Set Screws Type

0.8750 in	ID	22.23 mm
3.8976 in	SB	99.00 mm

Group No. FU 0071 - 1

SLB	UCFL 205 - 14
ASAHI	UCFL 205 - 14
BROWNING	VF 2 S - 214
FYH	UCFL 205 - 14
INA	RCJTY 7/8"
KOYO	UCFL 205 - 14 B
NACHI	UCFL 205 - 14
NSK	ULFL 205 - 14 S

NTN	UCFL 205 - 014 D 1
SEALMASTER	SFT - 14
SKF	FYT 7/8 TM

Group No. FU 0071 - 2

SLB	UELFL 205 - 14
FAFNIR	RCJT - 7/8
INA	RCJT 7/8"
KOYO	GFLL 1014 B
NACHI	UGFL 205 - 14 + ER
NTN	UELFL 205 - 014 D 1 W 3
SKF	FYT 7/8 WM

Group No. FU 0071 - 3

SLB	SAFL 205 - 14
BROWNING	VF2E - 114
INA	PCJT 7/8"
KOYO	GARAFL 014 BA
SKF	FYT 7/8 FM

Group No. FU 0071 - 4

SLB	SBFL 205 - 14
ASAHI	BFL 205 - 14
BROWNING	VF 2 S - 114
NACHI	BFL 205 - 14

Figure MU 22 
Heavy Duty
Two Bolts Flanged Units - Cast Housing
Set Screws Type

0.8750 in	ID	22.23 mm
4.4488 in	SB	113.00 mm

Group No. FU 0072 - 1

SLB	UCFL 305 - 14
ASAHI	UCFL 305 - 14
NSK	UCFL 305 - 14 S
NTN	UCFL 305 - 014 D 1

Figure MU 20 
Medium Duty
Two Bolts Flanged Units - Cast Housing
Set Screws Type

0.8750 in	ID	22.23 mm
4.6063 in	SB	117.00 mm

Group No. FU 0073 - 1

SLB	UCFL X05 - 14
ASAHI	UCFL X05 - 14
NTN	UCFL X05 - 014 D 1

Figure MU 11 
Standard Duty
Flanged Units - Cast Housing
Eccentric Locking Collar Type, Set Screws Type

0.8750 in	ID	22.23 mm
2.7559 in	SB	70.0 mm

Group No. FU 0074 - 1

SLB	UCFS 205 - 14
ASAHI	UCLF 205 - 14
FYH	SLF 205 - 14
LINK BELT	F 3 - U 214 N
RHP	SF 7/8

Group No. FU 0074 - 2

SLB	UELFS 205 - 14
BROWNING	VF 4 E - 214
FAFNIR	RCJ - 7/8
LINK BELT	F 3 - Y 214 N
NTN	UELFU 205 - 014 D 1 W 3
RHP	SF 7/8 DEC

Group No. FU 0074 - 3

SLB	SAFS 205 - 14
FAFNIR	VCJ - 7/8
LINK BELT	F 3 - W 214 U
RHP	SF 7/8 EC

Group No. FU 0074 - 4

SLB	SBFS 205 - 14
LINK BELT	F 3 - S 214 E

Figure MU 12

Standard Duty
Flanged Units - Cast Housing
Eccentric Locking Collar Type, Set Screws Type

0.9375 in	ID	23.81 mm
2.7559 in	SB	70.00 mm

Group No. FU 0075 - 1

SLB	UCF 205 - 15
ASAHI	UCF 205 - 15
BROWNING	VF 4 S - 215
FYH	UCF 205 - 15
KOYO	UCF 205 - 15
NACHI	UCF 205 - 15
NTN	UCF 205 - 015 D 1
SEALMASTER	SF - 15
SKF	FY 15/16 TM

Group No. FU 0075 - 2

SLB	UELF 205 - 15
INA	RCJ 15/16"
KOYO	GFF 1015 B
NACHI	UGF 205 - 15 + ER
NTN	UELF 205 - 015 D 1 W 3
SKF	FY 15/16 WM

Group No. FU 0075 - 3

SLB	SAF 205 - 15
BROWNING	VF 4 E - 115
KOYO	GARAF 015 A
SKF	FY 15/16 FM

Group No. FU 0075 - 4

SLB	SBF 205 - 15
ASAHI	BF 205 - 15
BROWNING	VF 4 S - 115
NACHI	BF 205 - 15

Figure MU 09

Standard Duty
Two Bolts Flanged Units - Pressed Steel Housing
Eccentric Locking Collar Type, Set Screws Type

0.9375 in	ID	23.81 mm
2.9921 in	SB	76.00 mm

Group No. FU 0076 - 1

SLB	SAPF 205 - 15
FAFNIR	RA - 15/16
KOYO	PF 015 A
LINK BELT	52 MSC 1 + 215
NACHI	KHPF 205 - 15 AE
NTN	AELPF 205 - 015 W 3
RHP	SLFE 15/16 EC
SKF	F 15/16 FM

Group No. FU 0076 - 2

SLB	SBPF 205 - 15
ASAHI	BPF 5 - 15
NACHI	BPF 5 - 15
NTN	ASPF 205 - 015

Figure MU 10

Standard Duty
Flanged Cartridge Units - Pressed Steel Housing
Eccentric Locking Collar Type, Set Screws Type

0.9375 in	ID	23.81 mm
2.9921 in	SB	76.00 mm

Group No. FU 0077 - 1

SLB	SAPFL 205 - 15
FAFNIR	RAT - 15/16
KOYO	PTF 015 A
LINK BELT	52 MST + 215
NACHI	KHPFL 205 - 15 AE
NTN	AELPFL 205 - 015 W 3
RHP	SLFL 15/16 EC
SKF	FT 15/16 FM

Group No. FU 0077 - 2

SLB	SBPFL 205 - 15
ASAHI	BPFL 5 - 15
NACHI	BPFL 5 - 15
NTN	ASPFL 205 - 015

Figure MU 21

Heavy Duty
Flanged Units - Cast Housing
Set Screws Type

0.9375 in	ID	23.81 mm
3.1496 in	SB	80.00 mm

Group No. FU 0078 - 1

SLB	UCF 305 - 15
NTN	UCF 305 - 015 D 1

Figure MU 19

Medium Duty
Flanged Units - Cast Housing
Set Screws Type

0.9375 in	ID	23.81 mm
3.2480 in	SB	82.50 mm

Group No. FU 0079 - 1

SLB	UCF X05 - 15
ASAHI	UCF X05 - 15
NTN	UCF X05 - 015 D 1
SEALMASTER	MSF - 15

Figure MU 13

Standard Duty
Flanged Cartridge Units - Cast Housing
Eccentric Locking Collar Type, Set Screws Type

0.9375 in	ID	23.81 mm
3.5433 in	SB	90.00 mm

Group No. FU 0080 - 1

SLB	UCFC 205 - 15
ASAHI	UCFC 205 - 15
FYH	UCFC 205 - 15
NACHI	UCFC 205 - 15
NTN	UCFC 205 - 015 D 1
RHP	FC 15/16

Group No. FU 0080 - 2

SLB	UELFC 205 - 15
NACHI	UGFC 205 - 15 + ER
NTN	UELFC 205 - 015 D 1 W 3
RHP	FC 15/16 DEC

Group No. FU 0080 - 3

SLB	SAFC 205 - 15
RHP	FC 15/16 EC

Group No. FU 0080 - 4

SLB	SBFC 205 - 15
NACHI	BFC 205 - 15

Figure MU 14

Standard Duty
Two Bolts Flanged Units - Cast Housing
Eccentric Locking Collar Type, Set Screws Type

0.9375 in	ID	23.81 mm
3.8976 in	SB	99.00 mm

Group No. FU 0081 - 1

SLB	UCFT 205 - 15
ASAHI	UCFT 205 - 15
LINK BELT	FX 3 - U 215 N
RHP	SFT 15/16

Group No. FU 0081 - 2

SLB	UELFT 205 - 15
BROWNING	VF 2 E - 215
LINK BELT	FX 3 - Y 215 N
NTN	UELFLU 205 - 015 D 1 W 3
RHP	SFT 15/16 DEC

Group No. FU 0081 - 3

SLB	SAFT 205 - 15
FAFNIR	VCJT - 15/16
LINK BELT	FX 3 - W 215 U
RHP	SFT 15/16 EC

Group No. FU 0081 - 4

SLB	SBFT 205 - 15
FAFNIR	SCJT - 15/16
LINK BELT	FX 3 - S 215 E

Figure MU 15

Standard Duty
Two Bolts Flanged Units - Cast Housing
Eccentric Locking Collar Type, Set Screws Type

0.9375 in	ID	23.81 mm
3.8976 in	SB	99.00 mm

Group No. FU 0082 - 1

SLB	UCFL 205 - 15
ASAHI	UCFL 205 - 15
BROWNING	VF2S - 215
FYH	UCFL 205 - 15
KOYO	UCFL 205 - 15 B
NACHI	UCFL 205 - 15
NTN	UCFL 205 - 015 D 1
SEALMASTER	SFT - 15
SKF	FYT 15/16 TM

Group No. FU 0082 - 2

SLB	UELFL 205 - 15
FAFNIR	RCJT - 15/16
INA	RCJT 15/16"
KOYO	GFFL 1015 B
NACHI	UGFL 205 - 15 + ER
NTN	UELFL 205 - 015 D 1 W 3
SKF	FYT 15/16 WM

Group No. FU 0082 - 3

SLB	SAFL 205 - 15
BROWNING	VF 2 E - 115
KOYO	GARAF 015 BA
SKF	FYT 15/16 FM

Group No. FU 0082 - 4

SLB	SBFL 205 - 15
ASAHI	BFL 205 - 15
BROWNING	VF 2 S - 115
NACHI	BFL 205 - 15

Figure MU 22

Heavy Duty
Two Bolts Flanged Units - Cast Housing
Set Screws Type

0.9375 in	ID	23.81 mm
4.4488 in	SB	113.00 mm

Group No. FU 0083 - 1

SLB	UCFL 305 - 15
NTN	UCFL 305 - 015 D 1

Figure MU 20

Medium Duty
Two Bolts Flanged Units - Cast Housing
Set Screws Type

0.9375 in	ID	23.81 mm
4.6063 in	SB	117.00 mm

Group No. FU 0084 - 1

SLB	UCFL X05 - 15
ASAHI	UCFL X05 - 15
NTN	UCFL X05 - 015 D 1
SEALMASTER	MSFT - 15

Figure MU 11

Standard Duty
Flanged Units - Cast Housing
Eccentric Locking Collar Type, Set Screws Type

0.9375 in	ID	23.81 mm
2.7559 in	SB	70.0 mm

Group No. FU 0085 - 1

SLB	UCFS 205 - 15
ASAHI	UCLF 205 - 15
FYH	SLF 205 - 15
LINK BELT	F 3 - U 215 N
RHP	SF 15/16

Group No. FU 0085 - 2

SLB	UELFS 205 - 15
BROWNING	VF 4 E - 215
FAFNIR	RCJ - 15/16
LINK BELT	F 3 - Y 215 N
NTN	UELFU 205 - 015 D 1 W 3
RHP	SF 15/16 DEC

Group No. FU 0085 - 3

SLB	SAFS 205 - 15
FAFNIR	VCJ - 15/16
LINK BELT	F 3 - W 215 U
RHP	SF 15/16 EC

Group No. FU 0085 - 4

SLB	SBFS 205 - 15
LINK BELT	F 3 - S 215 E

Figure MU 12

Standard Duty
Flanged Units - Cast Housing
Eccentric Locking Collar Type, Set Screws Type

0.9843 in	ID	25.00 mm
2.7559 in	SB	70.00 mm

Group No. FU 0086 - 1

SLB	UCF 205
ASAHI	UCF 205
FAG	FG 56205
FYH	UCF 205
INA	RCJY 25
KOYO	UCF 205
NACHI	UCF 205
NSK	UCF 205
NTN	UCF 205 D 1
SEALMASTER	SF - 205
SKF	FY 25 TM

Group No. FU 0086 - 2

SLB	UELFL 205
INA	RCJ 25
KOYO	GFF 1100 MB
NACHI	UGF 205 + ER
NSK	EW 205
NTN	UELFL 205 D 1 W 3
SKF	FY 25 WM

Group No. FU 0086 - 3

SLB	SAF 205
FAG	FG 16205
INA	PCJ 25
KOYO	GARAF 100 MA
SKF	FY 25 FM

Group No. FU 0086 - 4

SLB	SBF 205
ASAHI	BF 205
INA	PCJY 25
KOYO	PBF 16 MJ
NACHI	BF 205
NSK	UBF 205J

Figure MU 09

Standard Duty
Two Bolts Flanged Units - Pressed Steel Housing
Eccentric Locking Collar Type, Set Screws Type

0.9843 in	ID	25.00 mm
2.9921 in	SB	76.00 mm

Group No. FU 0087 - 1

SLB	SAPF 205
FAFNIR	RA - 25
FAG	FB 16205
FYH	SAPF 205
INA	RA 25
KOYO	PF 100 MA
LINK BELT	52 MSC 1 + 2 M 25
NACHI	KHPF 205 AE
NSK	ENPF 205
NTN	AELPF 205 W 3
RHP	SLFE 25 EC
SKF	F 25 FM
SNR	52 MSA + 1225 - 25 ECG

Group No. FU 0087 - 2

SLB	SBPF 205
ASAHI	BPF 5
FYH	SBPF 205
INA	RAY 25
NACHI	BPF 5
NSK	UBPF 205
NTN	ASPF 205
RHP	SLFE 25 A
SNR	52 MSA + 1225 - 25 G

Figure MU 10

Standard Duty
Flanged Cartridge Units - Pressed Steel Housing
Eccentric Locking Collar Type, Set Screws Type

0.9843 in	ID	25.00 mm
2.9921 in	SB	76.00 mm

Group No. FU 0088 - 1

SLB	SAPFL 205
FAFNIR	RAT - 25
FYH	SAPFL 205
INA	RAT 25
KOYO	PTF 100 MA
LINK BELT	52 MST + 2 M 25
NACHI	KHPFL 205 AE
NSK	ENPFL 205
NTN	AELPFL 205 W 3
RHP	SLFL 25 EC
SKF	FT 25 FM
SNR	52 MLA + 1225 - 25 ECG

Group No. FU 0088 - 2

SLB	SBPFL 205
ASAHI	BPFL 5
FYH	SBPFL 205
INA	RATY 25
NACHI	BPFL 5
NSK	UBPFL 205

NTN	ASPFL 205
RHP	SLFL 25 A
SNR	52 MLA + 1225 - 25 G

Figure MU 21

Heavy Duty
Flanged Units - Cast Housing
Set Screws Type

0.9843 in	ID	25.00 mm
3.1496 in	SB	80.00 mm

Group No. FU 0089 - 1

SLB	UCF 305
ASAHI	UCF 305
FYH	UCF 305
NSK	UCF 305
NTN	UCF 305 D 1

Figure MU 19

Medium Duty
Flanged Units - Cast Housing
Set Screws Type

0.9843 in	ID	25.00 mm
3.2480 in	SB	82.50 mm

Group No. FU 0090 - 1

SLB	UCF X05
ASAHI	UCF X05
FYH	UCF X05
NSK	UCF X05
NTN	UCF X05 D 1
RHP	MSF 25
SEALMASTER	MSF - 305
SNR	MSF 25

Figure MU 16

Standard Duty
Flanged Units - Cast Housing
Adapter Type

0.9843 in	ID	25.00 mm
3.2677 in	SB	83.00 mm

Group No. FU 0091 - 1

SLB	UKF 206
ASAHI	UKF 206
FYH	UKF 206
NACHI	UKF 206
NSK	UKF 206
NTN	UKF 206 D 1

Figure MU 13

Standard Duty
Flanged Cartridge Units - Cast Housing
Eccentric Locking Collar Type, Set Screws Type

0.9843 in	ID	25.00 mm
3.5433 in	SB	90.00 mm

Group No. FU 0092 - 1

SLB	UCFC 205
ASAHI	UCFC 205
FYH	UCFC 205
INA	RMEY 25
NACHI	UCFC 205
NSK	UCFC 205
NTN	UCFC 205 D 1
RHP	FC 25

Group No. FU 0092 - 2

SLB	UELFC 205
INA	RME 25
NACHI	UGFC 205 + ER
NSK	EWFC 205
NTN	UELFC 205 D 1 W 3
RHP	FC 25 DEC

Group No. FU 0092 - 3

SLB	SAFC 205
INA	PME 25
RHP	FC 25 EC

Group No. FU 0092 - 4

SLB	SBFC 205
NACHI	BFC 205
NSK	UBFC 205 J
RHP	FC 25 A

Figure MU 14

Standard Duty
Two Bolts Flanged Units - Cast Housing
Eccentric Locking Collar Type, Set Screws Type

0.9843 in	ID	25.00 mm
3.8976 in	SB	99.00 mm

Group No. FU 0093 - 1

SLB	UCFT 205
ASAHI	UCFT 205
LINK BELT	FX 3 - U 2 M 25 N
RHP	SFT 25
SNR	SFT 25

Group No. FU 0093 - 2

SLB	UELFT 205
NTN	UELFLU 205 D 1 W 3
RHP	SFT 25 DEC

Group No. FU 0093 - 3

SLB	SAFT 205
FAFNIR	VCJT - 25
RHP	SFT 25 EC
SNR	SFT 25 EC

Group No. FU 0093 - 4	
SLB	SBFT 205
FAFNIR	SCJT - 25
RHP	SFT 25 A
SNR	SFT 25 A

Figure MU 15		
<i>Standard Duty</i>		
<i>Two Bolts Flanged Units - Cast Housing</i>		
<i>Eccentric Locking Collar Type, Set Screws Type</i>		
0.9843 in	ID	25.00 mm
3.8976 in	SB	99.00 mm

Group No. FU 0094 - 1	
SLB	UCFL 205
ASAHI	UCFL 205
FYH	UCFL 205
INA	RCJTY 25
KOYO	UCFL 205 B
NACHI	UCFL 205
NSK	ULFL 205
NTN	UCFL 205 D 1
SEALMASTER	SFT - 205
SKF	FYT 25 TM

Group No. FU 0094 - 2	
SLB	UELFL 205
FAFNIR	RCJT - 25
INA	RCJT 25
KOYO	GGFL 1100 MB
NACHI	UGFL 205 + ER
NSK	EWFL 205
NTN	UELFL 205 D 1 W 3
SKF	FYT 25 WM

Group No. FU 0094 - 3	
SLB	SAFL 205
INA	PCJT 25
KOYO	GARAFL 100 MBA
SKF	FYT 25 FM

Group No. FU 0094 - 4	
SLB	SBFL 205
ASAHI	BFL 205
INA	PCJTY 25
KOYO	PBFL 16 MJ
NACHI	BFL 205
NSK	UBFL 205 J

Figure MU 17		
<i>Standard Duty</i>		
<i>Flanged Cartridge Units - Cast Housing</i>		
<i>Adapter Type</i>		
0.9843 in	ID	25.00 mm
3.9370 in	SB	100.00 mm

Group No. FU 0095 - 1	
SLB	UKFC 206
FYH	UKFC 206
NACHI	UKFC 206
NSK	UKFC 206
NTN	UKFC 206 D 1

Figure MU 22		
<i>Heavy Duty</i>		
<i>Two Bolts Flanged Units - Cast Housing</i>		
<i>Set Screws Type</i>		
0.9843 in	ID	25.00 mm
4.4488 in	SB	113.00 mm

Group No. FU 0096 - 1	
SLB	UCFL 305
ASAHI	UCFL 305
FYH	UCFL 305
NSK	UCFL 305
NTN	UCFL 305 D 1

Figure MU 18		
<i>Standard Duty</i>		
<i>Two Bolts Flanged Units - Cast Housing</i>		
<i>Adapter Type</i>		
0.9843 in	ID	25.00 mm
4.6063 in	SB	117.00 mm

Group No. FU 0097 - 1	
SLB	UKFL 206
FYH	UKFL 206
NACHI	UKFL 206
NSK	UKFL 206
NTN	UKFL 206 D 1

Figure MU 20		
<i>Medium Duty</i>		
<i>Two Bolts Flanged Units - Cast Housing</i>		
<i>Set Screws Type</i>		
0.9843 in	ID	25.00 mm
4.6063 in	SB	117.00 mm

Group No. FU 0098 - 1	
SLB	UCFL X05
ASAHI	UCFL X05
FYH	UCFL X05
NSK	UCFL X05
NTN	UCFL X05 D 1
RHP	MSFT 25
SEALMASTER	MSFT - 305

Figure MU 11		
<i>Standard Duty</i>		
<i>Flanged Units - Cast Housing</i>		
<i>Eccentric Locking Collar Type, Set Screws Type</i>		

0.9843 in	ID	25.00 mm
2.7559 in	SB	70.0 mm

Group No. FU 0099 - 1	
SLB	UCFS 205
ASAHI	UCLF 205
FYH	SLF 205
LINK BELT	F 3 - U 2 M 25 N
RHP	SF 25
SNR	SF 25

Group No. FU 0099 - 2	
SLB	UELFS 205
FAFNIR	RCJ - 25
NTN	UELFU 205 D 1 W 3
RHP	SF 25 DEC

Group No. FU 0099 - 3	
SLB	SAFS 205
FAFNIR	VCJ - 25
RHP	SF 25 EC
SNR	SF 25 EC

Group No. FU 0099 - 4	
SLB	SBFS 205
RHP	SF 25 A
SNR	SF 25 A

Figure MU 12		
<i>Standard Duty</i>		
<i>Flanged Units - Cast Housing</i>		
<i>Eccentric Locking Collar Type, Set Screws Type</i>		
1.0000 in	ID	25.40 mm
2.7559 in	SB	70.00 mm

Group No. FU 0100 - 1	
SLB	UCF 205 - 16
ASAHI	UCF 205 - 16
BROWNING	VF 4 S - 216
FAG	FG 56205.100
FYH	UCF 205 - 16
INA	RCJY 1"
KOYO	UCF 205 - 16
NACHI	UCF 205 - 16
NSK	UCF 205 - 16 S
NTN	UCF 205 - 100 D 1
SEALMASTER	SF - 16
SKF	FY 1 TM

Group No. FU 0100 - 2	
SLB	UELFL 205 - 16
INA	RCJ 1"
KOYO	GGF 1100 B
NACHI	UGF 205 - 16 + ER
NTN	UELFL 205 - 100 D 1 W 3
SKF	FY 1 WM

Group No. FU 0100 - 3		
SLB	SAF 205 - 16	
BROWNING	VF 4 E - 116	
FAG	FG 16205.100	
INA	PCJ 1"	
KOYO	GARAF 100 A	
SKF	FY 1 FM	

Group No. FU 0100 - 4		
SLB	SBF 205 - 16	
ASAHI	BF 205 - 16	
BROWNING	VF 4 S - 116	
NACHI	BF 205 - 16	

Figure MU 09 

Standard Duty
Two Bolts Flanged Units - Pressed Steel Housing
Eccentric Locking Collar Type, Set Screws Type

1.0000 in	ID	25.40 mm
2.9921 in	SB	76.00 mm

Group No. FU 0101 - 1		
SLB	SAPF 205 - 16	
FAFNIR	RA - 1	
FAG	FB 16205.100	
FYH	SAPF 205 - 16	
INA	RA 1"	
KOYO	PF 100 A	
LINK BELT	52 MSC 1 + 216	
NACHI	KHPF 205 - 16 AE	
NTN	AELPF 205 - 100 W 3	
RHP	SLFE 1 EC	
SKF	F 1 FM	

Group No. FU 0101 - 2		
SLB	SBPF 205 - 16	
ASAHI	BPF 5 - 16	
FYH	SBPF 205 - 16	
INA	RAY 1"	
NACHI	BPF 5 - 16	
NTN	ASPF 205 - 100	
RHP	SLFE 1 A	

Figure MU 10 

Standard Duty
Flanged Cartridge Units - Pressed Steel Housing
Eccentric Locking Collar Type, Set Screws Type

1.0000 in	ID	25.40 mm
2.9921 in	SB	76.00 mm

Group No. FU 0102 - 1		
SLB	SAPFL 205 - 16	
FAFNIR	RAT - 1	
FYH	SAPFL 205 - 16	
INA	RAT 1"	

KOYO	PTF 100 A
LINK BELT	52 MST + 216
NACHI	KHPFL 205 - 16 AE
NTN	AELPFL 205 - 100 W 3
RHP	SLFL 1 EC
SKF	FT 1 FM

Group No. FU 0102 - 2		
SLB	SBPFL 205 - 16	
ASAHI	BPFL 5 - 16	
FYH	SBPFL 205 - 16	
INA	RATY 1"	
NACHI	BPFL 5 - 16	
NTN	ASPFL 205 - 100	
RHP	SLFL 1 A	

Figure MU 21 

Heavy Duty
Flanged Units - Cast Housing
Set Screws Type

1.0000 in	ID	25.40 mm
3.1496 in	SB	80.00 mm

Group No. FU 0103 - 1		
SLB	UCF 305 - 16	
ASAHI	UCF 305 - 16	
FYH	UCF 305 - 16	
NSK	UCF 305 - 16 S	
NTN	UCF 305 - 100 D 1	

Figure MU 19 

Medium Duty
Flanged Units - Cast Housing
Set Screws Type

1.0000 in	ID	25.40 mm
3.2480 in	SB	82.50 mm

Group No. FU 0104 - 1		
SLB	UCF X05 - 16	
ASAHI	UCF X05 - 16	
BROWNING	VF 4 S - 316	
FYH	UCF X05 - 16	
NTN	UCF X05 - 100 D 1	
RHP	MSF 1	
SEALMASTER	MSF - 16	
SNR	MSF 1	

Figure MU 13 

Standard Duty
Flanged Cartridge Units - Cast Housing
Eccentric Locking Collar Type, Set Screws Type

1.0000 in	ID	25.40 mm
3.5433 in	SB	90.00 mm

Group No. FU 0105 - 1		
SLB	UCFC 205 - 16	
ASAHI	UCFC 205 - 16	
FYH	UCFC 205 - 16	
INA	RMEY 1"	
NACHI	UCFC 205 - 16	
NSK	UCFC 205 - 16 S	
NTN	UCFC 205 - 100 D 1	
RHP	FC 1	

Group No. FU 0105 - 2		
SLB	UELFC 205 - 16	
NACHI	UGFC 205 - 16 + ER	
NTN	UELFC 205 - 100 D 1 W 3	
RHP	FC 1 EDEC	

Group No. FU 0105 - 3		
SLB	SAFC 205 - 16	
RHP	FC 1 EC	

Group No. FU 0105 - 4		
SLB	SBFC 205 - 16	
NACHI	BFC 205 - 16	
RHP	FC 1 A	

Figure MU 14 

Standard Duty
Two Bolts Flanged Units - Cast Housing
Eccentric Locking Collar Type, Set Screws Type

1.0000 in	ID	25.40 mm
3.8976 in	SB	99.00 mm

Group No. FU 0106 - 1		
SLB	UCFT 205 - 16	
ASAHI	UCFT 205 - 16	
LINK BELT	FX 3 - U 216 N	
RHP	SFT 1	

Group No. FU 0106 - 2		
SLB	UELFT 205 - 16	
BROWNING	VF 2 E - 216	
LINK BELT	FX 3 - Y 216 N	
NTN	UELFLU 205 - 100 D 1 W 3	
RHP	SFT 1 EDEC	

Group No. FU 0106 - 3		
SLB	SAFT 205 - 16	
FAFNIR	VCJT - 1	
LINK BELT	FX 3 - W 216 U	
RHP	SFT 1 EC	

Group No. FU 0106 - 4		
SLB	SBFT 205 - 16	
FAFNIR	SCJT - 1	
LINK BELT	FX 3 - S 216 E	
RHP	SFT 1 A	

Figure MU 15

Standard Duty
Two Bolts Flanged Units - Cast Housing
Eccentric Locking Collar Type, Set Screws Type



1.0000 in	ID	25.40 mm
3.8976 in	SB	99.00 mm

Group No. FU 0107 - 1

SLB	UCFL 205 - 16
ASAHI	UCFL 205 - 16
BROWNING	VF 2 S - 216
FYH	UCFL 205 - 16
INA	RCJTY 1"
KOYO	UCFL 205 - 16 B
NACHI	UCFL 205 - 16
NSK	ULFL 205 - 16 S
NTN	UCFL 205 - 100 D 1
SEALMASTER	SFT - 16
SKF	FYT 1 TM

Group No. FU 0107 - 2

SLB	UELFL 205 - 16
FAFNIR	RCJT - 1
INA	RCJT 1"
KOYO	GFFL 1100 B
NACHI	UGFL 205 - 16 + ER
NTN	UELFL 205 - 100 D 1 W 3
SKF	FYT 1 WM

Group No. FU 0107 - 3

SLB	SAFL 205 - 16
BROWNING	VF 2 E - 116
INA	PCJT 1"
KOYO	GARAFL 100 BA
SKF	FYT 1 FM

Group No. FU 0107 - 4

SLB	SBFL 205 - 16
ASAHI	BFL 205 - 16
BROWNING	VF 2 S - 116
NACHI	BFL 205 - 16

Figure MU 22

Heavy Duty
Two Bolts Flanged Units - Cast Housing
Set Screws Type



1.0000 in	ID	25.40 mm
4.4488 in	SB	113.00 mm

Group No. FU 0108 - 1

SLB	UCFL 305 - 16
ASAHI	UCFL 305 - 16
FYH	UCFL 305 - 16
NSK	UCFL 305 - 16 S
NTN	UCFL 305 - 100 D 1

Figure MU 20

Medium Duty
Two Bolts Flanged Units - Cast Housing
Set Screws Type



1.0000 in	ID	25.40 mm
4.6063 in	SB	117.00 mm

Group No. FU 0109 - 1

SLB	UCFL X05 - 16
ASAHI	UCFL X05 - 16
FYH	UCFL X05 - 16
NTN	UCFL X05 - 100 D 1
RHP	MSFT 1
SEALMASTER	MSFT - 16

Figure MU 11

Standard Duty
Flanged Units - Cast Housing
Eccentric Locking Collar Type, Set Screws Type



1.0000 in	ID	25.40 mm
2.7559 in	SB	70.0 mm

Group No. FU 0110 - 1

SLB	UCFS 205 - 16
ASAHI	UCLF 205 - 16
FYH	SLF 205 - 16
LINK BELT	F 3 - U 216 N
RHP	SF 1

Group No. FU 0110 - 2

SLB	UELFS 205 - 16
BROWNING	VF 4 E - 216
FAFNIR	RCJ - 1
LINK BELT	F 3 - Y 216 N
NTN	UELFO 205 - 100 D 1 W 3
RHP	SF 1 EDEC

Group No. FU 0110 - 3

SLB	SAFS 205 - 16
FAFNIR	VCJ - 1
LINK BELT	F 3 - W 216 U
RHP	SF 1 EC

Group No. FU 0110 - 4

SLB	SBFS 205 - 16
LINK BELT	F 3 - S 216 E
RHP	SF 1 A

Figure MU 11

Standard Duty
Flanged Units - Cast Housing
Eccentric Locking Collar Type, Set Screws Type



1.0625 in	ID	26.99 mm
3.2480 in	SB	82.50 mm

Group No. FU 0111 - 1

SLB	UCFS 206 - 17
ASAHI	UCLF 206 - 17

Group No. FU 0111 - 2

SLB	UELFS 206 - 17
FAFNIR	RCJ - 1 - 1/16
NTN	UELFO 206 - 101 D 1 W 3

Group No. FU 0111 - 3

SLB	SAFS 206 - 17
FAFNIR	VCJ - 1 - 1/16

Figure MU 12

Standard Duty
Flanged Units - Cast Housing
Eccentric Locking Collar Type, Set Screws Type



1.0625 in	ID	26.99 mm
3.2677 in	SB	83.00 mm

Group No. FU 0112 - 1

SLB	UCF 206 - 17
ASAHI	UCF 206 - 17
NACHI	UCF 206 - 17
NTN	UCF 206 - 101 D 1
SEALMASTER	SF - 17
SKF	FY 1 - 1/16 TM

Group No. FU 0112 - 2

SLB	UEL 206 - 17
NTN	UEL 206 - 101 D 1 W 3
SKF	FY 1 - 1/16 WM

Group No. FU 0112 - 3

SLB	SAF 206 - 17
FAG	FG 16206.101
INA	PCJ 1 1/16"
SKF	FY 1 - 1/16 FM

Figure MU 09

Standard Duty
Two Bolts Flanged Units - Pressed Steel Housing
Eccentric Locking Collar Type, Set Screws Type



1.0625 in	ID	26.99 mm
3.5630 in	SB	90.50 mm

Group No. FU 0113 - 1

SLB	SAPF 206 - 17
FAFNIR	RA - 1 - 1/16
FAG	FB 16206.101
INA	RA 1 1/16"
NTN	AELPF 206 - 101 W 3
SKF	F 1 - 1/16 FM

Group No. FU 0113 - 2

SLB	SBPF 206 - 17
NTN	ASPF 206 - 101

Figure MU 10 
 Standard Duty
 Flanged Cartridge Units - Pressed Steel Housing
 Eccentric Locking Collar Type, Set Screws Type

1.0625 in	ID	26.99 mm
3.5630 in	SB	90.50 mm

Group No. FU 0114 - 1

SLB	SAPFL 206 - 17	
FAFNIR	RAT - 1 - 1/16	
INA	RAT 1 1/16"	
NTN	AELPFL 206 - 101 W 3	
SKF	FT 1 - 1/16 FM	

Group No. FU 0114 - 2

SLB	SBPFL 206 - 17	
NTN	ASPFL 206 - 101	

Figure MU 19 
 Medium Duty
 Flanged Units - Cast Housing
 Set Screws Type

1.0625 in	ID	26.99 mm
3.6220 in	SB	92.00 mm

Group No. FU 0115 - 1

SLB	UCF X06 - 17	
NTN	UCF X06 - 101 D 1	

Figure MU 21 
 Heavy Duty
 Flanged Units - Cast Housing
 Set Screws Type

1.0625 in	ID	26.99 mm
3.7402 in	SB	95.00 mm

Group No. FU 0116 - 1

SLB	UCF 306 - 17	
NTN	UCF 306 - 101 D 1	

Figure MU 13 
 Standard Duty
 Flanged Cartridge Units - Cast Housing
 Eccentric Locking Collar Type, Set Screws Type

1.0625 in	ID	26.99 mm
3.9370 in	SB	100.00 mm

Group No. FU 0117 - 1

SLB	UCFC 206 - 17	
ASAHI	UCFC 206 - 17	
NACHI	UCFC 206 - 17	
NTN	UCFC 206 - 101 D 1	

Group No. FU 0117 - 2

SLB	UELFC 206 - 17	
NTN	UELFC 206 - 101 D 1 W 3	

Figure MU 14 
 Standard Duty
 Two Bolts Flanged Units - Cast Housing
 Eccentric Locking Collar Type, Set Screws Type

1.0625 in	ID	26.99 mm
4.5866 in	SB	116.50 mm

Group No. FU 0118 - 1

SLB	UCFT 206 - 17	
ASAHI	UCFT 206 - 17	

Group No. FU 0118 - 2

SLB	UELFT 206 - 17	
NTN	UELFLU 206 - 101 D 1 W 3	

Group No. FU 0118 - 3

SLB	SAFT 206 - 17	
FAFNIR	VCJT - 1 - 1/16	

Figure MU 15 
 Standard Duty
 Two Bolts Flanged Units - Cast Housing
 Eccentric Locking Collar Type, Set Screws Type

1.0625 in	ID	26.99 mm
4.6063 in	SB	117.00 mm

Group No. FU 0119 - 1

SLB	UCFL 206 - 17	
ASAHI	UCFL 206 - 17	
NACHI	UCFL 206 - 17	
NTN	UCFL 206 - 101 D 1	
SEALMASTER	SFT - 17	
SKF	FYT 1 - 1/16 TM	

Group No. FU 0119 - 2

SLB	UELFL 206 - 17	
FAFNIR	RCJT - 1 - 1/16	
NTN	UELFL 206 - 101 D 1 W 3	
SKF	FYT 1 - 1/16 WM	

Group No. FU 0119 - 3

SLB	SAFL 206 - 17	
INA	PCJT 1 1/16"	
SKF	FYT 1 - 1/16 FM	

Figure MU 20 
 Medium Duty
 Two Bolts Flanged Units - Cast Housing
 Set Screws Type

1.0625 in	ID	26.99 mm
5.1181 in	SB	130.00 mm

Group No. FU 0120 - 1

SLB	UCFL X06 - 17	
NTN	UCFL X06 - 101 D 1	

Figure MU 22 
 Heavy Duty
 Two Bolts Flanged Units - Cast Housing
 Set Screws Type

1.0625 in	ID	26.99 mm
5.2756 in	SB	134.00 mm

Group No. FU 0121 - 1

SLB	UCFL 306 - 17	
NTN	UCFL 306 - 101 D 1	

Figure MU 11 
 Standard Duty
 Flanged Units - Cast Housing
 Eccentric Locking Collar Type, Set Screws Type

1.1250 in	ID	28.58 mm
3.2480 in	SB	82.50 mm

Group No. FU 0122 - 1

SLB	UCFS 206 - 18	
ASAHI	UCLF 206 - 18	
FYH	SLF 206 - 18	
LINK BELT	F 3 - U 218 N	
RHP	SF 1 1/8	

Group No. FU 0122 - 2

SLB	UELFS 206 - 18	
BROWNING	VF 4 E - 218	
FAFNIR	RCJ - 1 - 1/8	
LINK BELT	F 3 - Y 218 N	
NTN	UELFU 206 - 102 D 1 W 3	
RHP	SF 1 1/8 DEC	

Group No. FU 0122 - 3

SLB	SAFS 206 - 18	
FAFNIR	VCJ - 1 - 1/8	
LINK BELT	F 3 - W 218 E	
RHP	SF 1 1/8 EC	

Group No. FU 0122 - 4

SLB	SBFS 206 - 18	
LINK BELT	F 3 - S 218 E	

Figure MU 12 
 Standard Duty
 Flanged Units - Cast Housing
 Eccentric Locking Collar Type, Set Screws Type

1.1250 in	ID	28.58 mm
3.2677 in	SB	83.00 mm

Group No. FU 0123 - 1

SLB	UCF 206 - 18
ASAHI	UCF 206 - 18
BROWNING	VF 4 S - 218
FAG	FG 56206.102
FYH	UCF 206 - 18
INA	RCJY 1 1/8"
KOYO	UCF 206 - 18
NACHI	UCF 206 - 18
NSK	UCF 206 - 18 S
NTN	UCF 206 - 102 D 1
SEALMASTER	SF - 18
SKF	FY 1 - 1/8 TM

Group No. FU 0123 - 2

SLB	UELF 206 - 18
INA	RCJ 1 1/8"
KOYO	GFF 1102 B
NACHI	UGF 206 - 18 + ER
NTN	UELF 206 - 102 D 1 W 3
SKF	FY 1 - 1/8 WM

Group No. FU 0123 - 3

SLB	SAF 206 - 18
BROWNING	VF 4 E - 118
FAG	FG 16206.102
INA	PCJ 1 1/8"
KOYO	GARAF 102 A
SKF	FY 1 - 1/8 FM

Group No. FU 0123 - 4

SLB	SBF 206 - 18
ASAHI	BF 206 - 18
BROWNING	VF 4 S - 118
NACHI	BF 206 - 18

Figure MU 09

Standard Duty
Two Bolts Flanged Units - Pressed Steel Housing
Eccentric Locking Collar Type, Set Screws Type

1.1250 in	ID	28.58 mm
3.5630 in	SB	90.50 mm

Group No. FU 0124 - 1

SLB	SAPF 206 - 18
FAFNIR	RA - 1 - 1/8
FAG	FB 16206.102
FYH	SAPF 206 - 18
INA	RA 1 1/8"
KOYO	PF 102 A
LINK BELT	62 MSC 1 + 218
NACHI	KHPF 206 - 18 AE
NTN	AELPF 206 - 102 W 3
RHP	SLFE 1 1/8 EC
SKF	F 1 - 1/8 FM

Group No. FU 0124 - 2

SLB	SBPF 206 - 18
ASAHI	BPF 6 - 18
FYH	SBPF 206 - 18
NACHI	BPF 6 - 18
NTN	ASPF 206 - 102

Figure MU 10

Standard Duty
Flanged Cartridge Units - Pressed Steel Housing
Eccentric Locking Collar Type, Set Screws Type

1.1250 in	ID	28.58 mm
3.5630 in	SB	90.50 mm

Group No. FU 0125 - 1

SLB	SAPFL 206 - 18
FAFNIR	RAT - 1 - 1/8
FYH	SAPFL 206 - 18
INA	RAT 1 1/8"
KOYO	PTF 102 A
LINK BELT	62 MST + 218
NACHI	KHPFL 206 - 18 AE
NTN	AELPFL 206 - 102 W 3
RHP	SLFL 1 1/8 EC
SKF	FT 1 - 1/8 FM

Group No. FU 0125 - 2

SLB	SBPFL 206 - 18
ASAHI	BPFL 6 - 18
FYH	SBPFL 206 - 18
NACHI	BPFL 6 - 18
NTN	ASPFL 206 - 102

Figure MU 19

Medium Duty
Flanged Units - Cast Housing
Set Screws Type

1.1250 in	ID	28.58 mm
3.6220 in	SB	92.00 mm

Group No. FU 0126 - 1

SLB	UCF X06 - 18
ASAHI	UCF X06 - 18
NTN	UCF X06 - 102 D 1

Figure MU 21

Heavy Duty
Flanged Units - Cast Housing
Set Screws Type

1.1250 in	ID	28.58 mm
3.7402 in	SB	95.00 mm

Group No. FU 0127 - 1

SLB	UCF 306 - 18
ASAHI	UCF 306 - 18
FYH	UCF 306 - 18
NSK	UCF 306 - 18 S
NTN	UCF 306 - 102 D 1

Figure MU 13

Standard Duty
Flanged Cartridge Units - Cast Housing
Eccentric Locking Collar Type, Set Screws Type

1.1250 in	ID	28.58 mm
3.9370 in	SB	100.00 mm

Group No. FU 0128 - 1

SLB	UCFC 206 - 18
ASAHI	UCFC 206 - 18
FYH	UCFC 206 - 18
INA	RMEY 1 1/8"
NACHI	UCFC 206 - 18
NSK	UCFC 206 - 18 S
NTN	UCFC 206 - 102 D 1
RHP	FC 1 1/8

Group No. FU 0128 - 2

SLB	UELFC 206 - 18
NACHI	UGFC 206 - 18 + ER
NTN	UELFC 206 - 102 D 1 W 3
RHP	FC 1 1/8 DEC

Group No. FU 0128 - 3

SLB	SAFC 206 - 18
RHP	FC 1 1/8 EC

Group No. FU 0128 - 4

SLB	SBFC 206 - 18
NACHI	BFC 206 - 18

Figure MU 14

Standard Duty
Two Bolts Flanged Units - Cast Housing
Eccentric Locking Collar Type, Set Screws Type

1.1250 in	ID	28.58 mm
4.5866 in	SB	116.50 mm

Group No. FU 0129 - 1

SLB	UCFT 206 - 18
ASAHI	UCFT 206 - 18
LINK BELT	FX 3 - U 218 N
RHP	SFT 1 1/8

Group No. FU 0129 - 2

SLB	UELFT 206 - 18
BROWNING	VF 2 E - 218
LINK BELT	FX 3 - Y 218 N
NTN	UELFLU 206 - 102 D 1 W 3
RHP	SFT 1 1/8 DEC

Group No. FU 0129 - 3	
SLB	SAFT 206 - 18
FAFNIR	VCJT - 1 - 1/8
LINK BELT	FX 3 - W 218 E
RHP	SFT 1 1/8 EC
Group No. FU 0129 - 4	
SLB	SBFT 206 - 18
FAFNIR	SCJT - 1 - 1/8
LINK BELT	FX 3 - S 218 E

Figure MU 15 
Standard Duty
Two Bolts Flanged Units - Cast Housing
Eccentric Locking Collar Type, Set Screws Type

1.1250 in	ID	28.58 mm
4.6063 in	SB	117.00 mm

Group No. FU 0130 - 1	
SLB	UCFL 206 - 18
ASAHI	UCFL 206 - 18
BROWNING	VF 2 S - 218
FYH	UCFL 206 - 18
INA	RCJTY 1 1/8"
KOYO	UCFL 206 - 18 B
NACHI	UCFL 206 - 18
NSK	ULFL 206 - 18 S
NTN	UCFL 206 - 102 D 1
SEALMASTER	SFT - 18
SKF	FYT 1 - 1/8 TM

Group No. FU 0130 - 2	
SLB	UELFL 206 - 18
FAFNIR	RCJT - 1 - 1/8
INA	RCJT 1 1/8"
KOYO	GFFL 1102 B
NACHI	UGFL 206 - 18 + ER
NTN	UELFL 206 - 102 D 1 W 3
SKF	FYT 1 - 1/8 WM

Group No. FU 0130 - 3	
SLB	SAFL 206 - 18
BROWNING	VF 2 E - 118
INA	PCJT 1 1/8"
KOYO	GARAF 102 BA
SKF	FYT 1 - 1/8 FM

Group No. FU 0130 - 4	
SLB	SBFL 206 - 18
ASAHI	BFL 206 - 18
BROWNING	VF 2 S - 118
NACHI	BFL 206 - 18

Figure MU 20 
Medium Duty
Two Bolts Flanged Units - Cast Housing
Set Screws Type

1.1250 in	ID	28.58 mm
5.1181 in	SB	130.00 mm

Group No. FU 0131 - 1	
SLB	UCFL X06 - 18
ASAHI	UCFL X06 - 18
NTN	UCFL X06 - 102 D 1

Figure MU 22 
Heavy Duty
Two Bolts Flanged Units - Cast Housing
Set Screws Type

1.1250 in	ID	28.58 mm
5.2756 in	SB	134.00 mm

Group No. FU 0132 - 1	
SLB	UCFL 306 - 18
ASAHI	UCFL 306 - 18
FYH	UCFL 306 - 18
NSK	UCFL 306 - 18 S
NTN	UCFL 306 - 102 D 1

Figure MU 11 
Standard Duty
Flanged Units - Cast Housing
Eccentric Locking Collar Type, Set Screws Type

1.1811 in	ID	30.00 mm
3.2480 in	SB	82.50 mm

Group No. FU 0133 - 1	
SLB	UCFS 206
ASAHI	UCLF 206
FYH	SLF 206
LINK BELT	F 3 - U 2 M 30 N
RHP	SF 30
SNR	SF 30

Group No. FU 0133 - 2	
SLB	UELFS 206
FAFNIR	RCJ - 30
NTN	UELFU 206 D 1 W 3
RHP	SF 30 DEC

Group No. FU 0133 - 3	
SLB	SAFS 206
FAFNIR	VCJ - 30
RHP	SF 30 EC
SNR	SF 30 EC

Group No. FU 0133 - 4	
SLB	SBFS 206
RHP	SF 30 A
SNR	SF 30 A

Figure MU 12 
Standard Duty
Flanged Units - Cast Housing
Eccentric Locking Collar Type, Set Screws Type

1.1811 in	ID	30.00 mm
3.2677 in	SB	83.00 mm

Group No. FU 0134 - 1	
SLB	UCF 206
ASAHI	UCF 206
FAG	FG 56206
FYH	UCF 206
INA	RCJY 30
KOYO	UCF 206
NACHI	UCF 206
NSK	UCF 206
NTN	UCF 206 D 1
SEALMASTER	SF - 206
SKF	FY 30 TM

Group No. FU 0134 - 2	
SLB	UELFL 206
INA	RCJ 30
KOYO	GFF 1103 MB
NACHI	UGF 206 + ER
NSK	EW 206
NTN	UELFL 206 D 1 W 3
SKF	FY 30 WM

Group No. FU 0134 - 3	
SLB	SAF 206
FAG	FG 16206
INA	PCJ 30
KOYO	GARAF 103 MA
SKF	FY 30 FM

Group No. FU 0134 - 4	
SLB	SBF 206
ASAHI	BF 206
INA	PCJY 30
KOYO	PBF 19 MJ
NACHI	BF 206
NSK	UBF 206 J

Figure MU 09 
Standard Duty
Two Bolts Flanged Units - Pressed Steel Housing
Eccentric Locking Collar Type, Set Screws Type

1.1811 in	ID	30.00 mm
3.5630 in	SB	90.50 mm

Group No. FU 0135 - 1	
SLB	SAPF 206
FAFNIR	RA - 30
FAG	FB 16206
FYH	SAPF 206

INA	RA 30
KOYO	PF 103 MA
LINK BELT	62 MSC 1 + 2 M 30
NACHI	KHPF 206 AE
NSK	ENPF 206
NTN	AELPF 206 W 3
RHP	SLFE 30 EC
SKF	F 30 FM
SNR	62 MSA + 1230 - 30 ECG

Group No. FU 0135 - 2

SLB	SBPF 206
ASAHI	BPF 6
FYH	SBPF 206
INA	RAY 30
NACHI	BPF 6
NSK	UBPF 206
NTN	ASPF 206
RHP	SLFE 30 A
SNR	62 MSA + 1230 - 30 G

Figure MU 10

Standard Duty
Flanged Cartridge Units - Pressed Steel Housing
Eccentric Locking Collar Type, Set Screws Type

1.1811 in	ID	30.00 mm
3.5630 in	SB	90.50 mm

Group No. FU 0136 - 1

SLB	SAPFL 206
FAFNIR	RAT - 30
FYH	SAPFL 206
INA	RAT 30
KOYO	PTF 103 MA
LINK BELT	62 MST + 2 M 30
NACHI	KHPFL 206 AE
NSK	ENPFL 206
NTN	AELPFL 206 W 3
RHP	SLFL 30 EC
SKF	FT 30 FM
SNR	62 MLA + 1230 - 30 ECG

Group No. FU 0136 - 2

SLB	SBPFL 206
ASAHI	BPFL 6
FYH	SBPFL 206
INA	RATY 30
NACHI	BPFL 6
NSK	UBPFL 206
NTN	ASPFL 206
RHP	SLFL 30 A
SNR	62 MLA + 1230 - 30 G

Figure MU 16

Standard Duty
Flanged Units - Cast Housing
Adapter Type

1.1811 in	ID	30.00 mm
3.6220 in	SB	92.00 mm

Group No. FU 0137 - 1

SLB	UKF 207
ASAHI	UKF 207
FYH	UKF 207
NACHI	UKF 207
NSK	UKF 207
NTN	UKF 207 D 1

Figure MU 19

Medium Duty
Flanged Units - Cast Housing
Set Screws Type

1.1811 in	ID	30.00 mm
3.6220 in	SB	92.00 mm

Group No. FU 0138 - 1

SLB	UCF X06
ASAHI	UCF X06
FYH	UCF X06
NSK	UCF X06
NTN	UCF X06 D 1
RHP	MSF 30
SEALMASTER	MSF - 306
SNR	MSF 30

Figure MU 21

Heavy Duty
Flanged Units - Cast Housing
Set Screws Type

1.1811 in	ID	30.00 mm
3.7402 in	SB	95.00 mm

Group No. FU 0139 - 1

SLB	UCF 306
ASAHI	UCF 306
FYH	UCF 306
INA	RCJOY 30
NSK	UCF 306
NTN	UCF 306 D 1

Figure MU 13

Standard Duty
Flanged Cartridge Units - Cast Housing
Eccentric Locking Collar Type, Set Screws Type

1.1811 in	ID	30.00 mm
3.9370 in	SB	100.00 mm

Group No. FU 0140 - 1

SLB	UCFC 206
ASAHI	UCFC 206

FYH	UCFC 206
INA	RMEY 30
NACHI	UCFC 206
NSK	UCFC 206
NTN	UCFC 206 D 1
RHP	FC 30

Group No. FU 0140 - 2

SLB	UELFC 206
INA	RME 30
NACHI	UGFC 206 + ER
NSK	EWFC 206
NTN	UELFC 206 D 1 W 3
RHP	FC 30 DEC

Group No. FU 0140 - 3

SLB	SAFC 206
INA	PME 30
RHP	FC 30 EC

Group No. FU 0140 - 4

SLB	SBFC 206
NACHI	BFC 206
NSK	UBFC 206 J
RHP	FC 30 A

Figure MU 17

Standard Duty
Flanged Cartridge Units - Cast Housing
Adapter Type

1.1811 in	ID	30.00 mm
4.3307 in	SB	110.00 mm

Group No. FU 0141 - 1

SLB	UKFC 207
FYH	UKFC 207
NACHI	UKFC 207
NSK	UKFC 207
NTN	UKFC 207 D 1

Figure MU 14

Standard Duty
Two Bolts Flanged Units - Cast Housing
Eccentric Locking Collar Type, Set Screws Type

1.1811 in	ID	30.00 mm
4.5866 in	SB	116.50 mm

Group No. FU 0142 - 1

SLB	UCFT 206
ASAHI	UCFT 206
LINK BELT	FX 3 - U 2 M 30 N
RHP	SFT 30
SNR	SFT 30

Group No. FU 0142 - 2	
SLB	UELFT 206
NTN	UELFLU 206 D 1 W 3
RHP	SFT 30 DEC

Group No. FU 0142 - 3	
SLB	SAFT 206
FAFNIR	VCJT - 30
RHP	SFT 30 EC
SNR	SFT 30 EC

Group No. FU 0142 - 4	
SLB	SBFT 206
FAFNIR	SCJT - 30
RHP	SFT 30 A
SNR	SFT 30 A

Figure MU 15		
<i>Standard Duty</i>		
<i>Two Bolts Flanged Units - Cast Housing</i>		
<i>Eccentric Locking Collar Type, Set Screws Type</i>		
1.1811 in	ID	30.00 mm
4.6063 in	SB	117.00 mm

Group No. FU 0143 - 1	
SLB	UCFL 206
ASAHI	UCFL 206
FYH	UCFL 206
INA	RCJTY 30
KOYO	UCFL 206 B
NACHI	UCFL 206
NSK	ULFL 206
NTN	UCFL 206 D 1
SEALMASTER	SFT - 206
SKF	FYT 30 TM

Group No. FU 0143 - 2	
SLB	UELFL 206
FAFNIR	RCJT - 30
INA	RCJT 30
KOYO	GFFL 1103 MB
NACHI	UGFL 206 + ER
NSK	EWFL 206
NTN	UELFL 206 D 1 W 3
SKF	FYT 30 WM

Group No. FU 0143 - 3	
SLB	SAFL 206
INA	PCJT 30
KOYO	GARAFL 103 MBA
SKF	FYT 30 FM

Group No. FU 0143 - 4	
SLB	SBFL 206
ASAHI	BFL 206
INA	PCJTY 30
KOYO	PBFL 19 MJ
NACHI	BFL 206
NSK	UBFL 206 J

Figure MU 18			
<i>Standard Duty</i>			
<i>Two Bolts Flanged Units - Cast Housing</i>			
<i>Adapter Type</i>			
1.1811 in	ID	30.00 mm	
5.1181 in	SB	130.00 mm	

Group No. FU 0144 - 1	
SLB	UKFL 207
FYH	UKFL 207
NACHI	UKFL 207
NSK	UKFL 207
NTN	UKFL 207 D 1

Figure MU 20			
<i>Medium Duty</i>			
<i>Two Bolts Flanged Units - Cast Housing</i>			
<i>Set Screws Type</i>			
1.1811 in	ID	30.00 mm	
5.1181 in	SB	130.00 mm	

Group No. FU 0145 - 1	
SLB	UCFL X06
ASAHI	UCFL X06
FYH	UCFL X06
NSK	UCFL X06
NTN	UCFL X06 D 1
RHP	MSFT 30
SEALMASTER	MSFT - 306

Figure MU 22			
<i>Heavy Duty</i>			
<i>Two Bolts Flanged Units - Cast Housing</i>			
<i>Set Screws Type</i>			
1.1811 in	ID	30.00 mm	
5.2756 in	SB	134.00 mm	

Group No. FU 0146 - 1	
SLB	UCFL 306
ASAHI	UCFL 306
FYH	UCFL 306
NSK	UCFL 306
NTN	UCFL 306 D 1

Figure MU 11			
<i>Standard Duty</i>			
<i>Flanged Units - Cast Housing</i>			
<i>Eccentric Locking Collar Type, Set Screws Type</i>			
1.1875 in	ID	30.16 mm	
3.2480 in	SB	82.50 mm	

Group No. FU 0147 - 1	
SLB	UCFS 206 - 19
ASAHI	UCLF 206 - 19

FYH	SLF 206 - 19
LINK BELT	F 3 - U 219 N
RHP	SF 1 3/16

Group No. FU 0147 - 2	
SLB	UELFS 206 - 19
BROWNING	VF 4 E - 219
FAFNIR	RCJ - 1 - 3/16
LINK BELT	F 3 - Y 219 N
NTN	UELFU 206 - 103 D 1 W 3
RHP	SF 1 3/16 DEC

Group No. FU 0147 - 3	
SLB	SAFS 206 - 19
FAFNIR	VCJ - 1 - 3/16
LINK BELT	F 3 - W 219 E
RHP	SF 1 3/16 EC

Group No. FU 0147 - 4	
SLB	SBFS 206 - 19
LINK BELT	F 3 - S 219 E

Figure MU 12			
<i>Standard Duty</i>			
<i>Flanged Units - Cast Housing</i>			
<i>Eccentric Locking Collar Type, Set Screws Type</i>			
1.1875 in	ID	30.16 mm	
3.2677 in	SB	83.00 mm	

Group No. FU 0148 - 1	
SLB	UCF 206 - 19
ASAHI	UCF 206 - 19
BROWNING	VF 4 S - 219
FAG	FG 56206.103
FYH	UCF 206 - 19
KOYO	UCF 206 - 19
NACHI	UCF 206 - 19
NTN	UCF 206 - 103 D 1
SEALMASTER	SF - 19
SKF	FY 1 - 3/16 TM

Group No. FU 0148 - 2	
SLB	UELFL 206 - 19
INA	RCJ 1 3/16"
KOYO	GFF 1103 B
NACHI	UGF 206 - 19 + ER
NTN	UELFL 206 - 103 D 1 W 3
SKF	FY 1 - 3/16 WM

Group No. FU 0148 - 3	
SLB	SAF 206 - 19
BROWNING	VF 4 E - 119
FAG	FG 16206.103
INA	PCJ 1 3/16"
KOYO	GARAF 103 A
SKF	FY 1 - 3/16 FM

Group No. FU 0148 - 4	
SLB	SBF 206 - 19
ASAHI	BF 206 - 19
BROWNING	VF 4 S - 119
NACHI	BF 206 - 19

Figure MU 09 	
<i>Standard Duty</i>	
<i>Two Bolts Flanged Units - Pressed Steel Housing</i>	
<i>Eccentric Locking Collar Type, Set Screws Type</i>	
1.1875 in	ID 30.16 mm
3.5630 in	SB 90.50 mm

Group No. FU 0149 - 1	
SLB	SAPF 206 - 19
FAFNIR	RA - 1 - 3/16
FAG	FB 16206.103
FYH	SAPF 206 - 19
INA	RA 1 3/16"
KOYO	PF 103 A
LINK BELT	62 MSC 1 + 219
NACHI	KHPF 206 - 19 AE
NTN	AELPF 206 - 103 W 3
RHP	SLFE 1 3/16 EC
SKF	F 1 - 3/16 FM

Group No. FU 0149 - 2	
SLB	SBPF 206 - 19
ASAHI	BPF 6 - 19
FYH	SBPF 206 - 19
NACHI	BPF 6 - 19
NTN	ASPFL 206 - 103

Figure MU 10 	
<i>Standard Duty</i>	
<i>Flanged Cartridge Units - Pressed Steel Housing</i>	
<i>Eccentric Locking Collar Type, Set Screws Type</i>	
1.1875 in	ID 30.16 mm
3.5630 in	SB 90.50 mm

Group No. FU 0150 - 1	
SLB	SAPFL 206 - 19
FAFNIR	RAT - 1 - 3/16
FYH	SAPFL 206 - 19
INA	RAT 1 3/16"
KOYO	PTF 103 A
LINK BELT	62 MST + 219
NACHI	KHPFL 206 - 19 AE
NTN	AELPFL 206 - 103 W 3
RHP	SLFL 1 3/16 EC
SKF	FT 1 - 3/16 FM

Group No. FU 0150 - 2	
SLB	SBPFL 206 - 19
ASAHI	BPFL 6 - 19

FYH	SBPFL 206 - 19
NACHI	BPFL 6 - 19
NTN	ASPFL 206 - 103

Figure MU 19 	
<i>Medium Duty</i>	
<i>Flanged Units - Cast Housing</i>	
<i>Set Screws Type</i>	
1.1875 in	ID 30.16 mm
3.6220 in	SB 92.00 mm

Group No. FU 0151 - 1	
SLB	UCF X06 - 19
ASAHI	UCF X06 - 19
BROWNING	VF 4 S - 319
FYH	UCF X06 - 19
NTN	UCF X06 - 103 D 1
RHP	MSF 1 3/16
SEALMASTER	MSF - 19
SNR	MSF 1 3/16

Figure MU 21 	
<i>Heavy Duty</i>	
<i>Flanged Units - Cast Housing</i>	
<i>Set Screws Type</i>	
1.1875 in	ID 30.16 mm
3.7402 in	SB 95.00 mm

Group No. FU 0152 - 1	
SLB	UCF 306 - 19
NTN	UCF 306 - 103 D 1

Figure MU 13 	
<i>Standard Duty</i>	
<i>Flanged Cartridge Units - Cast Housing</i>	
<i>Eccentric Locking Collar Type, Set Screws Type</i>	
1.1875 in	ID 30.16 mm
3.9370 in	SB 100.00 mm

Group No. FU 0153 - 1	
SLB	UCFC 206 - 19
ASAHI	UCFC 206 - 19
FYH	UCFC 206 - 19
NACHI	UCFC 206 - 19
NTN	UCFC 206 - 103 D 1
RHP	FC 1 3/16

Group No. FU 0153 - 2	
SLB	UELFC 206 - 19
NACHI	UGFC 206 - 19 + ER
NTN	UELFC 206 - 103 D 1 W 3
RHP	FC 1 3/16 DEC

Group No. FU 0153 - 3	
SLB	SAFC 206 - 19
RHP	FC 1 3/16 EC

Group No. FU 0153 - 4	
SLB	SBFC 206 - 19
NACHI	BFC 206 - 19

Figure MU 14 	
<i>Standard Duty</i>	
<i>Two Bolts Flanged Units - Cast Housing</i>	
<i>Eccentric Locking Collar Type, Set Screws Type</i>	
1.1875 in	ID 30.16 mm
4.5866 in	SB 116.50 mm

Group No. FU 0154 - 1	
SLB	UCFT 206 - 19
ASAHI	UCFT 206 - 19
LINK BELT	FX 3 - U 219 N
RHP	SFT 1 3/16

Group No. FU 0154 - 2	
SLB	UELFT 206 - 19
BROWNING	VF 2 E - 219
LINK BELT	FX 3 - Y 219 N
NTN	UELFLU 206 - 103 D 1 W 3
RHP	SFT 1 3/16 DEC

Group No. FU 0154 - 3	
SLB	SAFT 206 - 19
FAFNIR	VCJT - 3/16
LINK BELT	FX 3 - W 219 E
RHP	SFT 1 3/16 EC

Group No. FU 0154 - 4	
SLB	SBFT 206 - 19
FAFNIR	SCJT - 1 - 3/16
LINK BELT	FX 3 - S 219 E

Figure MU 15 	
<i>Standard Duty</i>	
<i>Two Bolts Flanged Units - Cast Housing</i>	
<i>Eccentric Locking Collar Type, Set Screws Type</i>	
1.1875 in	ID 30.16 mm
4.6063 in	SB 117.00 mm

Group No. FU 0155 - 1	
SLB	UCFL 206 - 19
ASAHI	UCFL 206 - 19
BROWNING	VF 2 S - 219
FYH	UCFL 206 - 19
KOYO	UCFL 206 - 19 B
NACHI	UCFL 206 - 19
NTN	UCFL 206 - 103 D 1
SEALMASTER	SFT - 19
SKF	FYT 1 - 3/16 TM

Group No. FU 0155 - 2	
SLB	UELFL 206 - 19
FAFNIR	RCJT - 1 - 3/16
INA	RCJT 1 3/16"
KOYO	GFFL 1103 B
NACHI	UGFL 206 - 19 + ER
NTN	UELFL 206 - 103 D 1 W 3
SKF	FYT 1 - 3/16 WM

Group No. FU 0155 - 3	
SLB	SAFL 206 - 19
BROWNING	VF 2 E - 119
INA	PCJT 1 3/16"
KOYO	GARAF 103 BA
SKF	FYT 1 - 3/16 FM

Group No. FU 0155 - 4	
SLB	SBFL 206 - 19
ASAHI	BFL 206 - 19
BROWNING	VF 2 S - 119
NACHI	BFL 206 - 19

Figure MU 20		
<i>Medium Duty</i>		
<i>Two Bolts Flanged Units - Cast Housing</i>		
<i>Set Screws Type</i>		
1.1875 in	ID	30.16 mm
5.1181 in	SB	130.00 mm

Group No. FU 0156 - 1	
SLB	UCFL X06 - 19
ASAHI	UCFL X06 - 19
FYH	UCFL X06 - 19
NTN	UCFL X06 - 103 D 1
RHP	MSFT 1 3/16
SEALMASTER	MSFT - 19

Figure MU 22		
<i>Heavy Duty</i>		
<i>Two Bolts Flanged Units - Cast Housing</i>		
<i>Set Screws Type</i>		
1.1875 in	ID	30.16 mm
5.2756 in	SB	134.00 mm

Group No. FU 0157 - 1	
SLB	UCFL 306 - 19
NTN	UCFL 306 - 103 D 1

Figure MU 11		
<i>Standard Duty</i>		
<i>Flanged Units - Cast Housing</i>		
<i>Eccentric Locking Collar Type, Set Screws Type</i>		
1.2500 in	ID	31.75 mm
3.2480 in	SB	82.50 mm

Group No. FU 0158 - 1	
SLB	UCFS 206 - 20
LINK BELT	F 3 - U 2 E 20 N
RHP	SF 1 1/4 R

Group No. FU 0158 - 2	
SLB	UELFS 206 - 20
BROWNING	VF 4 E - 220 S
LINK BELT	F 3 - Y 2 E 20 N
NTN	UELFU 206 - 104 D 1 W 3
RHP	SF 1 1/4 DECR

Group No. FU 0158 - 3	
SLB	SAFS 206 - 20
FAFNIR	VCJ - 1 - 1/4 S
LINK BELT	F 3 - W 2 E 20 E
RHP	SF 1 1/4 ECR

Group No. FU 0158 - 4	
SLB	SBFS 206 - 20
LINK BELT	F 3 - S 2 E 20 E
RHP	SF 1 1/4 AR

Figure MU 12		
<i>Standard Duty</i>		
<i>Flanged Units - Cast Housing</i>		
<i>Eccentric Locking Collar Type, Set Screws Type</i>		
1.2500 in	ID	31.75 mm
3.2677 in	SB	83.00 mm

Group No. FU 0159 - 1	
SLB	UCF 206 - 20
BROWNING	VF 4 S - 220 S
INA	RCJY 1 1/4" - 206
NTN	UCF 206 - 104 D 1
SEALMASTER	SF - 20 R
SKF	FY 1 - 1/4 ATM

Group No. FU 0159 - 2	
SLB	UELF 206 - 20
INA	RCJ 1 1/4" - 206
KOYO	GFF 1104 B - 1
NACHI	UGF 206 - 20 + ER
NTN	UELF 206 - 104 D 1 W 3
SKF	FY 1 - 1/4 AWM

Group No. FU 0159 - 3	
SLB	SAF 206 - 20
BROWNING	VF 4 E - 120 S
FAG	FG 16206.104
INA	PCJ 1 1/4" - 206
KOYO	GARAF 104 A - 1
SKF	FY 1 - 1/4 AFM

Group No. FU 0159 - 4	
SLB	SBF 206 - 20
BROWNING	VF 4 S - 120 S

Figure MU 09		
<i>Standard Duty</i>		
<i>Two Bolts Flanged Units - Pressed Steel Housing</i>		
<i>Eccentric Locking Collar Type, Set Screws Type</i>		
1.2500 in	ID	31.75 mm
3.5630 in	SB	90.50 mm

Group No. FU 0160 - 1	
SLB	SAPF 206 - 20
FAFNIR	RA - 1 - 1/4 S
FAG	FB 16206.104
FYH	SAPF 206 - 20
INA	RA 1 1/4" - 206
KOYO	PF 104 A - 1
LINK BELT	62 MSC 1 + 2 E 20
NACHI	KHPF 206 - 20 AE
NTN	AELPF 206 - 104 W 3
RHP	SLFE 1 1/4 EC
SKF	F 1 - 1/4 AFM

Group No. FU 0160 - 2	
SLB	SBPF 206 - 20
NTN	ASPF 206 - 104
RHP	SLFE 1 1/4 A

Figure MU 10		
<i>Standard Duty</i>		
<i>Flanged Cartridge Units - Pressed Steel Housing</i>		
<i>Eccentric Locking Collar Type, Set Screws Type</i>		
1.2500 in	ID	31.75 mm
3.5630 in	SB	90.50 mm

Group No. FU 0161 - 1	
SLB	SAPFL 206 - 20
FAFNIR	RAT - 1 - 1/4 S
FYH	SAPFL 206 - 20
INA	RAT 1 1/4" - 206
KOYO	PTF 103 A - 1
LINK BELT	62 MST + 2 E 20
NACHI	KHPFL 206 - 20 AE
NTN	AELPFL 206 - 104 W 3
RHP	SLFL 1 1/4 EC
SKF	FT 1 - 1/4 AFM

Group No. FU 0161 - 2	
SLB	SBPFL 206 - 20
NTN	ASPFL 206 - 104
RHP	SLFL 1 1/4 A

Figure MU 12		
<i>Standard Duty</i>		
<i>Flanged Units - Cast Housing</i>		
<i>Eccentric Locking Collar Type, Set Screws Type</i>		
1.2500 in	ID	31.75 mm
3.6220 in	SB	92.00 mm

Group No. FU 0162 - 1	
SLB	UCF 207 - 20
ASAHI	UCF 207 - 20
BROWNING	VF 4 S - 220
FAG	FG 56207.104
FYH	UCF 207 - 20
INA	RCJY 1 1/4"
KOYO	UCF 207 - 20
NACHI	UCF 207 - 20
NSK	UCF 207 - 20 S
NTN	UCF 207 - 104 D 1
SEALMASTER	SF - 20
SKF	FY 1 - 1/4 TM

Group No. FU 0162 - 2	
SLB	UELF 207 - 20
INA	RCJ 1 1/4"
KOYO	GFF 1104 B
NACHI	UGF 207 - 20 + ER
NTN	UELF 207 - 104 D 1 W 3
SKF	FY 1 - 1/4 WM

Group No. FU 0162 - 3	
SLB	SAF 207 - 20
INA	PCJ 1 1/4"
KOYO	GARAF 104 A
SKF	FY 1 - 1/4 FM

Group No. FU 0162 - 4	
SLB	SBF 207 - 20
ASAHI	BF 207 - 20
NACHI	BF 207 - 20

Figure MU 19 
Medium Duty
 Flanged Units - Cast Housing
 Set Screws Type

1.2500 in	ID	31.75 mm
3.6220 in	SB	92.00 mm

Group No. FU 0163 - 1	
SLB	UCF X06 - 20
ASAHI	UCF X06 - 20
FYH	UCF X06 - 20
NTN	UCF X06 - 104 D 1
RHP	MSF 1 1/4
SEALMASTER	MSF - 20
SNR	MSF 1 1/4

Figure MU 21 
Heavy Duty
 Flanged Units - Cast Housing
 Set Screws Type

1.2500 in	ID	31.75 mm
3.7402 in	SB	95.00 mm

Group No. FU 0164 - 1	
SLB	UCF 306 - 20
FYH	UCF 306 - 20

Figure MU 09 
Standard Duty
 Two Bolts Flanged Units - Pressed Steel Housing
 Eccentric Locking Collar Type, Set Screws Type

1.2500 in	ID	31.75 mm
3.9370 in	SB	100.00 mm

Group No. FU 0165 - 1	
SLB	SAPF 207 - 20
FAFNIR	RA - 1 - 1/4
FYH	SAPF 207 - 20
INA	RA 1 1/4"
KOYO	PF 104 A
LINK BELT	72 MSC 1 + 220
NACHI	KHPF 207 - 20 AE
NTN	AELPF 207 - 104 W 3
RHP	SLFE 1 1/4 ECL
SKF	F 1 - 1/4 FM

Group No. FU 0165 - 2	
SLB	SBPF 207 - 20
ASAHI	BPF 7 - 20
FYH	SBPF 207 - 20
NACHI	BPF 7 - 20
NTN	ASPF 207 - 104
RHP	SLFE 1 1/4 AL

Figure MU 10 
Standard Duty
 Flanged Cartridge Units - Pressed Steel Housing
 Eccentric Locking Collar Type, Set Screws Type

1.2500 in	ID	31.75 mm
3.9370 in	SB	100.00 mm

Group No. FU 0166 - 1	
SLB	SAPFL 207 - 20
FAFNIR	RAT - 1 - 1/4 S
INA	RAT 1 1/4"
NACHI	KHPFL 207 - 20 AE
NTN	AELPFL 207 - 104 W 3
SKF	FT 1 - 1/4 FM

Group No. FU 0166 - 2	
SLB	SBPFL 207 - 20
ASAHI	BPFL 7 - 20
NACHI	BPFL 7 - 20
NTN	ASPFL 207 - 104

Figure MU 13 
Standard Duty
 Flanged Cartridge Units - Cast Housing
 Eccentric Locking Collar Type, Set Screws Type

1.2500 in	ID	31.75 mm
3.9370 in	SB	100.00 mm

Group No. FU 0167 - 1	
SLB	UCFC 206 - 20
INA	RMEY 1 1/4" - 206
NTN	UCFC 206 - 104 D 1
RHP	FC 1 1/4 R

Group No. FU 0167 - 2	
SLB	UELFC 206 - 20
NACHI	UGFC 206 - 20 + ER
NTN	UELFC 206 - 104 D 1 W 3
RHP	FC 1 1/4 DECR

Group No. FU 0167 - 3	
SLB	SAFC 206 - 20
RHP	FC 1 1/4 ECR

Group No. FU 0167 - 4	
SLB	SBFC 206 - 20
RHP	FC 1 1/4 AR

Figure MU 21 
Heavy Duty
 Flanged Units - Cast Housing
 Set Screws Type

1.2500 in	ID	31.75 mm
3.9370 in	SB	100.00 mm

Group No. FU 0168 - 1	
SLB	UCF 307 - 20
ASAHI	UCF 307 - 20
FYH	UCF 307 - 20
NSK	UCF 307 - 20 S
NTN	UCF 307 - 104 D 1

Figure MU 19 
Medium Duty
 Flanged Units - Cast Housing
 Set Screws Type

1.2500 in	ID	31.75 mm
3.9961 in	SB	101.50 mm

Group No. FU 0169 - 1	
SLB	UCF X07 - 20
FYH	UCF X07 - 20

Figure MU 13 
Standard Duty
 Flanged Cartridge Units - Cast Housing
 Eccentric Locking Collar Type, Set Screws Type

1.2500 in	ID	31.75 mm
4.3307 in	SB	110.00 mm

Group No. FU 0170 - 1	
SLB	UCFC 207 - 20
ASAHI	UCFC 207 - 20
FYH	UCFC 207 - 20
INA	RMEY 1 1/4"
NACHI	UCFC 207 - 20
NSK	UCFC 207 - 20 S
NTN	UCFC 207 - 104 D 1
RHP	FC 1 1/4

Group No. FU 0170 - 2	
SLB	UELFC 207 - 20
NACHI	UGFC 207 - 20 + ER
NTN	UELFC 207 - 104 D 1 W 3
RHP	FC 1 1/4 DEC

Group No. FU 0170 - 3	
SLB	SAFC 207 - 20
RHP	FC 1 1/4 EC

Group No. FU 0170 - 4	
SLB	SBFC 207 - 20
NACHI	BFC 207 - 20
RHP	FC 1 1/4 A

Figure MU 14		
<i>Standard Duty</i>		
<i>Two Bolts Flanged Units - Cast Housing</i>		
<i>Eccentric Locking Collar Type, Set Screws Type</i>		
1.2500 in	ID	31.75 mm
4.5866 in	SB	116.50 mm

Group No. FU 0171 - 1	
SLB	UCFT 206 - 20
LINK BELT	FX 3 - U 2 E 20 N
RHP	SFT 1 1/4 R

Group No. FU 0171 - 2	
SLB	UELFT 206 - 20
BROWNING	VF 2 E - 220 S
LINK BELT	FX 3 - Y 2 E 20 N
NTN	UELFLU 206 - 104 D 1 W 3
RHP	SFT 1 1/4 DECR

Group No. FU 0171 - 3	
SLB	SAFT 206 - 20
FAFNIR	VCJT - 1 - 1/4 S
LINK BELT	FX 3 - W 2 E 20 E
RHP	SFT 1 1/4 ECR

Group No. FU 0171 - 4	
SLB	SBFT 206 - 20
FAFNIR	SCJT - 1 - 1/4 S
LINK BELT	FX 3 - S 2 E 20 E
RHP	SFT 1 1/4 AR

Figure MU 15		
<i>Standard Duty</i>		
<i>Two Bolts Flanged Units - Cast Housing</i>		
<i>Eccentric Locking Collar Type, Set Screws Type</i>		
1.2500 in	ID	31.75 mm
4.6063 in	SB	117.00 mm

Group No. FU 0172 - 1	
SLB	UCFL 206 - 20
BROWNING	VF 2 S - 220 S
INA	RCJTY 1 1/4" - 206
NTN	UCFL 206 - 104 D 1
SEALMASTER	SFT - 20 R
SKF	FYT 1 - 1/4 ATM

Group No. FU 0172 - 2	
SLB	UELFL 206 - 20
INA	RCJT 1 1/4" - 206
KOYO	GFFL 1103 B - 1
NACHI	UGFL 206 - 20 + ER
NTN	UELFL 206 - 104 D 1 W 3
SKF	FYT 1 - 1/4 AWM

Group No. FU 0172 - 3	
SLB	SAFL 206 - 20
BROWNING	VF 2 E - 120 S
INA	PCJT 1 1/4" - 206
KOYO	GARAFL 103 BA - 1
SKF	FYT 1 - 1/4 AFM

Group No. FU 0172 - 4	
SLB	SBFL 206 - 20
BROWNING	VF 2 S - 120 S

Figure MU 14		
<i>Standard Duty</i>		
<i>Two Bolts Flanged Units - Cast Housing</i>		
<i>Eccentric Locking Collar Type, Set Screws Type</i>		
1.2500 in	ID	31.75 mm
5.1181 in	SB	130.00 mm

Group No. FU 0173 - 1	
SLB	UCFT 207 - 20
ASAHI	UCFT 207 - 20
LINK BELT	FX 3 - U 220 N
RHP	SFT 1 1/4

Group No. FU 0173 - 2	
SLB	UELFT 207 - 20
BROWNING	VF 2 E - 220
LINK BELT	FX 3 - Y 220 N
NTN	UELFLU 207 - 104 D 1 W 3
RHP	SFT 1 1/4 DEC

Group No. FU 0173 - 3	
SLB	SAFT 207 - 20
FAFNIR	VCJT - 1 - 1/4

LINK BELT	FX 3 - W 220 E
RHP	SFT 1 1/4 EC

Group No. FU 0173 - 4	
SLB	SBFT 207 - 20
FAFNIR	SCJT - 1 - 1/4
LINK BELT	FX 3 - S 220 E
RHP	SFT 1 1/4 A

Figure MU 15		
<i>Standard Duty</i>		
<i>Two Bolts Flanged Units - Cast Housing</i>		
<i>Eccentric Locking Collar Type, Set Screws Type</i>		
1.2500 in	ID	31.75 mm
5.1181 in	SB	130.00 mm

Group No. FU 0174 - 1	
SLB	UCFL 207 - 20
ASAHI	UCFL 207 - 20
BROWNING	VF 2 S - 220
FYH	UCFL 207 - 20
INA	RCJTY 1 1/4"
KOYO	UCFL 207 - 20 B
NACHI	UCFL 207 - 20
NSK	ULFL 207 - 20 S
NTN	UCFL 207 - 104 D 1
SEALMASTER	SFT - 20
SKF	FYT 1 - 1/4 TM

Group No. FU 0174 - 2	
SLB	UELFL 207 - 20
FAFNIR	RCJT - 1 - 1/4
INA	RCJT 1 1/4"
KOYO	GFFL 1104 B
NACHI	UGFL 207 - 20 + ER
NTN	UELFL 207 - 104 D 1 W 3
SKF	FYT 1 - 1/4 WM

Group No. FU 0174 - 3	
SLB	SAFL 207 - 20
INA	PCJT 1 1/4"
KOYO	GARAFL 104 BA
SKF	FYT 1 - 1/4 FM

Group No. FU 0174 - 4	
SLB	SBFL 207 - 20
ASAHI	BFL 207 - 20
NACHI	BFL 207 - 20

Figure MU 20		
<i>Medium Duty</i>		
<i>Two Bolts Flanged Units - Cast Housing</i>		
<i>Set Screws Type</i>		
1.2500 in	ID	31.75 mm
5.1181 in	SB	130.00 mm

Group No. FU 0175 - 1	
SLB	UCFL X06 - 20
ASAHI	UCFL X06 - 20
FYH	UCFL X06 - 20
NTN	UCFL X06 - 104 D 1
RHP	MSFT 1 1/4
SEALMASTER	MSFT - 20

Figure MU 22		
<i>Heavy Duty</i>		
<i>Two Bolts Flanged Units - Cast Housing</i>		
<i>Set Screws Type</i>		
1.2500 in	ID	31.75 mm
5.2756 in	SB	134.00 mm

Group No. FU 0176 - 1	
SLB	UCFL 306 - 20
FYH	UCFL 306 - 20

Figure MU 22		
<i>Heavy Duty</i>		
<i>Two Bolts Flanged Units - Cast Housing</i>		
<i>Set Screws Type</i>		
1.2500 in	ID	31.75 mm
5.5512 in	SB	141.00 mm

Group No. FU 0177 - 1	
SLB	UCFL 307 - 20
ASAHI	UCFL 307 - 20
FYH	UCFL 307 - 20
NSK	UCFL 307 - 20 S
NTN	UCFL 307 - 104 D 1

Figure MU 20		
<i>Medium Duty</i>		
<i>Two Bolts Flanged Units - Cast Housing</i>		
<i>Set Screws Type</i>		
1.2500 in	ID	31.75 mm
5.6693 in	SB	144.00 mm

Group No. FU 0178 - 1	
SLB	UCFL X07 - 20
FYH	UCFL X07 - 20

Figure MU 11		
<i>Standard Duty</i>		
<i>Flanged Units - Cast Housing</i>		
<i>Eccentric Locking Collar Type, Set Screws Type</i>		
1.2500 in	ID	31.75 mm
3.6220 in	SB	92.0 mm

Group No. FU 0179 - 1	
SLB	UCFS 207 - 20
ASAHI	UCLF 207 - 20
FYH	SLF 207 - 20
LINK BELT	F 3 - U 220 N
RHP	SF 1 1/4

Group No. FU 0179 - 2	
SLB	UELFS 207 - 20
BROWNING	VF 4 E - 220
FAFNIR	RCJ - 1 - 1/4
LINK BELT	F 3 - Y 220 N
NTN	UELFU 207 - 104 D 1 W 3
RHP	SF 1 1/4 DEC

Group No. FU 0179 - 3	
SLB	SAFS 207 - 20
FAFNIR	VCJ - 1 - 1/4 S
LINK BELT	F 3 - W 220 E
RHP	SF 1 1/4 EC

Group No. FU 0179 - 4	
SLB	SBFS 207 - 20
LINK BELT	F 3 - 220 E
RHP	SF 1 1/4 A

Figure MU 12		
<i>Standard Duty</i>		
<i>Flanged Units - Cast Housing</i>		
<i>Eccentric Locking Collar Type, Set Screws Type</i>		
1.3125 in	ID	33.34 mm
3.6220 in	SB	92.00 mm

Group No. FU 0180 - 1	
SLB	UCF 207 - 21
ASAHI	UCF 207 - 21
FYH	UCF 207 - 21
KOYO	UCF 207 - 21
NACHI	UCF 207 - 21
NTN	UCF 207 - 105 D 1
SEALMASTER	SF - 21
SKF	FY 1 - 5/16 TM

Group No. FU 0180 - 2	
SLB	UELF 207 - 21
KOYO	GFF 1105 B
NACHI	UGF 207 - 21 + ER
NTN	UELF 207 - 105 D 1 W 3
SKF	FY 1 - 5/16 WM

Group No. FU 0180 - 3	
SLB	SAF 207 - 21
KOYO	GARAF 105 A
SKF	FY 1 - 5/16 FM

Group No. FU 0180 - 4	
SLB	SBF 207 - 21
ASAHI	BF 207 - 21
NACHI	BF 207 - 21

Figure MU 09		
<i>Standard Duty</i>		
<i>Two Bolts Flanged Units - Pressed Steel Housing</i>		
<i>Eccentric Locking Collar Type, Set Screws Type</i>		
1.3125 in	ID	33.34 mm
3.9370 in	SB	100.00 mm

Group No. FU 0181 - 1	
SLB	SAPF 207 - 21
FAFNIR	RA - 1 - 5/16
KOYO	PF 105 A
NACHI	KHPF 207 - 21 AE
NTN	AELPF 207 - 105 W 3
SKF	F 1 - 5/16 FM

Group No. FU 0181 - 2	
SLB	SBPF 207 - 21
ASAHI	BPF 7 - 21
NACHI	BPF 7 - 21
NTN	ASPF 207 - 105

Figure MU 10		
<i>Standard Duty</i>		
<i>Flanged Cartridge Units - Pressed Steel Housing</i>		
<i>Eccentric Locking Collar Type, Set Screws Type</i>		
1.3125 in	ID	33.34 mm
3.9370 in	SB	100.00 mm

Group No. FU 0182 - 1	
SLB	SAPFL 207 - 21
FAFNIR	RAT - 1 - 5/16
NACHI	KHPFL 207 - 21 AE
NTN	AELPFL 207 - 105 W 3

Group No. FU 0182 - 2	
SLB	SBPFL 207 - 21
ASAHI	BPFL 7 - 21
NACHI	BPFL 7 - 21
NTN	ASPFL 207 - 105

Figure MU 21		
<i>Heavy Duty</i>		
<i>Flanged Units - Cast Housing</i>		
<i>Set Screws Type</i>		
1.3125 in	ID	33.34 mm
3.9370 in	SB	100.00 mm

Group No. FU 0183 - 1	
SLB	UCF 307 - 21
NTN	UCF 307 - 105 D 1

Figure MU 19		
<i>Medium Duty</i>		
<i>Flanged Units - Cast Housing</i>		
<i>Set Screws Type</i>		

1.3125 in	ID	33.34 mm
3.9961 in	SB	101.50 mm

Group No. FU 0184 - 1		
SLB	UCF X07 - 21	
NTN	UCF X07 - 105 D 1	

Figure MU 13
Standard Duty
Flanged Cartridge Units - Cast Housing
Eccentric Locking Collar Type, Set Screws Type

1.3125 in	ID	33.34 mm
4.3307 in	SB	110.00 mm

Group No. FU 0185 - 1		
SLB	UCFC 207 - 21	
ASAHI	UCFC 207 - 21	
FYH	UCFC 207 - 21	
NACHI	UCFC 207 - 21	
NTN	UCFC 207 - 105 D 1	

Group No. FU 0185 - 2		
SLB	UELFC 207 - 21	
NACHI	UGFC 207 - 21 + ER	
NTN	UELFC 207 - 105 D 1 W 3	

Group No. FU 0185 - 3		
SLB	SBFC 207 - 21	
NACHI	BFC 207 - 21	

Figure MU 14
Standard Duty
Two Bolts Flanged Units - Cast Housing
Eccentric Locking Collar Type, Set Screws Type

1.3125 in	ID	33.34 mm
5.1181 in	SB	130.00 mm

Group No. FU 0186 - 1		
SLB	UCFT 207 - 21	
ASAHI	UCFT 207 - 21	

Group No. FU 0186 - 2		
SLB	UELFT 207 - 21	
NTN	UELFLU 207 - 105 D 1 W 3	

Group No. FU 0186 - 3		
SLB	SAFT 207 - 21	
FAFNIR	VCJT - 1 - 5/16	

Figure MU 15
Standard Duty
Two Bolts Flanged Units - Cast Housing
Eccentric Locking Collar Type, Set Screws Type

1.3125 in	ID	33.34 mm
5.1181 in	SB	130.00 mm

Group No. FU 0187 - 1		
SLB	UCFL 207 - 21	
ASAHI	UCFL 207 - 21	
FYH	UCFL 207 - 21	
KOYO	UCFL 207 - 21 B	
NACHI	UCFL 207 - 21	
NTN	UCFL 207 - 105 D 1	
SEALMASTER	SFT - 21	
SKF	FYT 1 - 5/16 TM	

Group No. FU 0187 - 2		
SLB	UELFL 207 - 21	
FAFNIR	RCJT - 1 - 5/16	
KOYO	GFFL 1105 B	
NACHI	UGFL 207 - 21 + ER	
NTN	UELFL 207 - 105 D 1 W 3	
SKF	FYT 1 - 5/16 WM	

Group No. FU 0187 - 3		
SLB	SAFL 207 - 21	
KOYO	GARAF 105 BA	
SKF	FYT 1 - 5/16 FM	

Group No. FU 0187 - 4		
SLB	SBFL 207 - 21	
ASAHI	BFL 207 - 21	
NACHI	BFL 207 - 21	

Figure MU 22
Heavy Duty
Two Bolts Flanged Units - Cast Housing
Set Screws Type

1.3125 in	ID	33.34 mm
5.5512 in	SB	141.00 mm

Group No. FU 0188 - 1		
SLB	UCFL 307 - 21	
NTN	UCFL 307 - 105 D 1	

Figure MU 20
Medium Duty
Two Bolts Flanged Units - Cast Housing
Set Screws Type

1.3125 in	ID	33.34 mm
5.6693 in	SB	144.00 mm

Group No. FU 0189 - 1		
SLB	UCFL X07 - 21	
NTN	UCFL X07 - 105 D 1	

Figure MU 11
Standard Duty
Flanged Units - Cast Housing
Eccentric Locking Collar Type, Set Screws Type

1.3125 in	ID	33.34 mm
3.6220 in	SB	92.0 mm

Group No. FU 0190 - 1		
SLB	UCFS 207 - 21	
ASAHI	UCLF 207 - 21	
FYH	SLF 207 - 21	

Group No. FU 0190 - 2		
SLB	UELFS 207 - 21	
FAFNIR	RCJ - 1 - 5/16	
NTN	UELFU 207 - 105 D 1 W 3	

Group No. FU 0190 - 3		
SLB	SAFS 207 - 21	
FAFNIR	VCJ - 1 - 5/16	

Figure MU 12
Standard Duty
Flanged Units - Cast Housing
Eccentric Locking Collar Type, Set Screws Type

1.3750 in	ID	34.93 mm
3.6220 in	SB	92.00 mm

Group No. FU 0191 - 1		
SLB	UCF 207 - 22	
ASAHI	UCF 207 - 22	
BROWNING	VF 4 S - 222	
FAG	FG 56207.106	
FYH	UCF 207 - 22	
INA	RCJY 1 3/8"	
KOYO	UCF 207 - 22	
NACHI	UCF 207 - 22	
NSK	UCF 207 - 22 S	
NTN	UCF 207 - 106 D 1	
SEALMASTER	SF - 22	
SKF	FY 1 - 3/8 TM	

Group No. FU 0191 - 2		
SLB	UELFL 207 - 22	
INA	RCJ 1 3/8"	
KOYO	GFF 1106 B	
NACHI	UGF 207 - 22 + ER	
NTN	UELF 207 - 106 D 1 W 3	
SKF	FY 1 - 3/8 WM	

Group No. FU 0191 - 3		
SLB	SAF 207 - 22	
BROWNING	VF 4 E - 122	
FAG	FG 16207.106	
INA	PCJ 1 3/8"	
KOYO	GARAF 106 A	
SKF	FY 1 - 3/8 FM	

Group No. FU 0191 - 4		
SLB	SBF 207 - 22	
ASAHI	BF 207 - 22	
BROWNING	VF 4 S - 122	
NACHI	BF 207 - 22	

Figure MU 09

Standard Duty
Two Bolts Flanged Units - Pressed Steel Housing
Eccentric Locking Collar Type, Set Screws Type

1.3750 in	ID	34.93 mm
3.9370 in	SB	100.00 mm

Group No. FU 0192 - 1

SLB	SAPF 207 - 22
FAFNIR	RA - 1 - 3/8
FAG	FB 16207.106
FYH	SAPF 207 - 22
INA	RA 1 3/8"
KOYO	PF 106 A
LINK BELT	72 MSC 1 + 222
NACHI	KHPF 207 - 22 AE
NTN	AELPF 207 - 106 W 3
RHP	SLFE 1 3/8 EC
SKF	F 1 - 3/8 FM

Group No. FU 0192 - 2

SLB	SBPF 207 - 22
ASAHI	BPF 7 - 22
FYH	SBPF 207 - 22
NACHI	BPF 7 - 22
NTN	ASPF 207 - 106

Figure MU 10

Standard Duty
Flanged Cartridge Units - Pressed Steel Housing
Eccentric Locking Collar Type, Set Screws Type

1.3750 in	ID	34.93 mm
3.9370 in	SB	100.00 mm

Group No. FU 0193 - 1

SLB	SAPFL 207 - 22
FAFNIR	RAT - 1 - 3/8
INA	RAT 1 3/8"
NACHI	KHPFL 207 - 22 AE
NTN	AELPFL 207 - 106 W 3
SKF	FT 1 - 3/8 FM

Group No. FU 0193 - 2

SLB	SBPFL 207 - 22
ASAHI	BPFL 7 - 22
NACHI	BPFL 7 - 22
NTN	ASPFL 207 - 106

Figure MU 21

Heavy Duty
Flanged Units - Cast Housing
Set Screws Type

1.3750 in	ID	34.93 mm
3.9370 in	SB	100.00 mm

Group No. FU 0194 - 1

SLB	UCF 307 - 22
ASAHI	UCF 307 - 22
FYH	UCF 307 - 22
NTN	UCF 307 - 106 D 1

Figure MU 19

Medium Duty
Flanged Units - Cast Housing
Set Screws Type

1.3750 in	ID	34.93 mm
3.9961 in	SB	101.50 mm

Group No. FU 0195 - 1

SLB	UCF X07 - 22
ASAHI	UCF X07 - 22
FYH	UCF X07 - 22
NTN	UCF X07 - 106 D 1
RHP	MSF 1 3/8
SNR	MSF 1 3/8

Figure MU 13

Standard Duty
Flanged Cartridge Units - Cast Housing
Eccentric Locking Collar Type, Set Screws Type

1.3750 in	ID	34.93 mm
4.3307 in	SB	110.00 mm

Group No. FU 0196 - 1

SLB	UCFC 207 - 22
ASAHI	UCFC 207 - 22
FYH	UCFC 207 - 22
INA	RMEY 1 3/8"
NACHI	UCFC 207 - 22
NSK	UCFC 207 - 22 S
NTN	UCFC 207 - 106 D 1
RHP	FC 1 3/8

Group No. FU 0196 - 2

SLB	UELFC 207 - 22
NACHI	UGFC 207 - 22 + ER
NTN	UELFC 207 - 106 D 1 W 3
RHP	FC 1 3/8 DEC

Group No. FU 0196 - 3

SLB	SAFC 207 - 22
RHP	FC 1 3/8 EC

Group No. FU 0196 - 4

SLB	SBFC 207 - 22
NACHI	BFC 207 - 22

Figure MU 14

Standard Duty
Two Bolts Flanged Units - Cast Housing
Eccentric Locking Collar Type, Set Screws Type

1.3750 in	ID	34.93 mm
5.1181 in	SB	130.00 mm

Group No. FU 0197 - 1

SLB	UCFT 207 - 22
ASAHI	UCFT 207 - 22
LINK BELT	FX 3 - U 222 N
RHP	SFT 1 3/8

Group No. FU 0197 - 2

SLB	UELFT 207 - 22
BROWNING	VF 2 E - 222
LINK BELT	FX 3 - Y 222 N
NTN	UELFLU 207 - 106 D 1 W 3
RHP	SFT 1 3/8 DEC

Group No. FU 0197 - 3

SLB	SAFT 207 - 22
FAFNIR	VCJT - 1 - 3/8
LINK BELT	FX 3 - W 222 E
RHP	SFT 1 3/8 EC

Group No. FU 0197 - 4

SLB	SBFT 207 - 22
FAFNIR	SCJT - 1 - 3/8
LINK BELT	FX 3 - S 222 E

Figure MU 15

Standard Duty
Two Bolts Flanged Units - Cast Housing
Eccentric Locking Collar Type, Set Screws Type

1.3750 in	ID	34.93 mm
5.1181 in	SB	130.00 mm

Group No. FU 0198 - 1

SLB	UCFL 207 - 22
ASAHI	UCFL 207 - 22
BROWNING	VF 2 S - 222
FYH	UCFL 207 - 22
INA	RCJTY 1 3/8"
KOYO	UCFL 207 - 22 B
NACHI	UCFL 207 - 22
NSK	ULFL 207 - 22 S
NTN	UCFL 207 - 106 D 1
SEALMASTER	SFT - 22
SKF	FYT 1 - 3/8 TM

Group No. FU 0198 - 2

SLB	UELFL 207 - 22
FAFNIR	RCJT - 1 - 3/8
INA	RCJT 1 3/8"
KOYO	GFLL 1106 B
NACHI	UGFL 207 - 22 + ER
NTN	UELFL 207 - 106 D 1 W 3
SKF	FYT 1 - 3/8 WM

Group No. FU 0198 - 3

SLB	SAFL 207 - 22
BROWNING	VF 2 E - 122

INA	PCJT 1 3/8"
KOYO	GARAFL 106 BA
SKF	FYT 1 - 3/8 FM
Group No. FU 0198 - 4	
SLB	SBFL 207 - 22
ASAHI	BFL 207 - 22
BROWNING	VF 2 S - 122
NACHI	BFL 207 - 22

Figure MU 22 

Heavy Duty
Two Bolts Flanged Units - Cast Housing
Set Screws Type

1.3750 in	ID	34.93 mm
5.5512 in	SB	141.00 mm

Group No. FU 0199 - 1

SLB	UCFL 307 - 22
ASAHI	UCFL 307 - 22
FYH	UCFL 307 - 22
NTN	UCFL 307 - 106 D 1

Figure MU 20 

Medium Duty
Two Bolts Flanged Units - Cast Housing
Set Screws Type

1.3750 in	ID	34.93 mm
5.6693 in	SB	144.00 mm

Group No. FU 0200 - 1

SLB	UCFL X07 - 22
ASAHI	UCFL X07 - 22
FYH	UCFL X07 - 22
NTN	UCFL X07 - 106 D 1
RHP	MSFT 1 3/8

Figure MU 11 

Standard Duty
Flanged Units - Cast Housing
Eccentric Locking Collar Type, Set Screws Type

1.3750 in	ID	34.93 mm
3.6220 in	SB	92.0 mm

Group No. FU 0201 - 1

SLB	UCFS 207 - 22
ASAHI	UCLF 207 - 22
FYH	SLF 207 - 22
LINK BELT	F 3 - U 222 N
RHP	SF 1 3/8

Group No. FU 0201 - 2

SLB	UELFS 207 - 22
BROWNING	VF 4 E - 222

FAFNIR	RCJ - 1 - 3/8
LINK BELT	F 3 - Y 222 N
NTN	UELFU 207 - 106 D 1 W 3
RHP	SF 1 3/8 DEC
Group No. FU 0201 - 3	
SLB	SAFS 207 - 22
FAFNIR	VCJ - 1 - 3/8
LINK BELT	F 3 - W 222 E
RHP	SF 1 3/8 EC

Group No. FU 0201 - 4

SLB	SBFS 207 - 22
LINK BELT	F 3 - S 222 E

Figure MU 12 

Standard Duty
Flanged Units - Cast Housing
Eccentric Locking Collar Type, Set Screws Type

1.3780 in	ID	35.00 mm
3.6220 in	SB	92.00 mm

Group No. FU 0202 - 1

SLB	UCF 207
ASAHI	UCF 207
FAG	FG 56207
FYH	UCF 207
INA	RCJY 35
KOYO	UCF 207
NACHI	UCF 207
NSK	UCF 207
NTN	UCF 207 D 1
SEALMASTER	SF - 207
SKF	FY 35 TM

Group No. FU 0202 - 2

SLB	UELFL 207
INA	RCJ 35
KOYO	GFF 1106 MB
NACHI	UGF 207 + ER
NSK	EFW 207
NTN	UELFL 207 D 1 W 3
SKF	FY 35 WM

Group No. FU 0202 - 3

SLB	SAF 207
FAG	FG 16207
INA	PCJ 35
KOYO	GARAF 106 MA
SKF	FY 35 FM

Group No. FU 0202 - 4

SLB	SBF 207
ASAHI	BF 207
INA	PCJY 35
KOYO	PBF 22 MJ
NACHI	BF 207
NSK	UBF 207 J

Figure MU 09 

Standard Duty
Two Bolts Flanged Units - Pressed Steel Housing
Eccentric Locking Collar Type, Set Screws Type

1.3780 in	ID	35.00 mm
3.9370 in	SB	100.00 mm

Group No. FU 0203 - 1

SLB	SAPF 207
FAFNIR	RA - 35
FAG	FB 16207
FYH	SAPF 207
INA	RA 35
KOYO	PF 106 MA
LINK BELT	72 MSC 1 + 2 M 35
NACHI	KHPF 207 AE
NSK	ENPF 207
NTN	AELPF 207 W 3
RHP	SLFE 35 EC
SKF	F 35 FM
SNR	72 MSA + 1235 - 35 ECG

Group No. FU 0203 - 2

SLB	SBPF 207
ASAHI	BPF 7
FYH	SBPF 207
INA	RAY 35
NACHI	BPF 7
NSK	UBPF 207
NTN	ASPF 207
RHP	SLFE 35 A
SNR	72 MSA + 1235 - 35 G

Figure MU 10 

Standard Duty
Flanged Cartridge Units - Pressed Steel Housing
Eccentric Locking Collar Type, Set Screws Type

1.3780 in	ID	35.00 mm
3.9370 in	SB	100.00 mm

Group No. FU 0204 - 1

SLB	SAPFL 207
FAFNIR	RAT - 35
INA	RAT 35
NACHI	KHPFL 207 AE
NSK	ENPFL 207
NTN	AELPFL 207 W 3
SKF	FT 35 FM
SNR	72 MLA + 1235 - 35 ECG

Group No. FU 0204 - 2

SLB	SBPFL 207
ASAHI	BPFL 7
INA	RATY 35
NACHI	BPFL 7
NSK	UBPFL 207
NTN	ASPF 207
SNR	72 MLA + 1235 - 35 G

Figure MU 21
Heavy Duty
 Flanged Units - Cast Housing
 Set Screws Type

1.3780 in	ID	35.00 mm
3.9370 in	SB	100.00 mm

Group No. FU 0205 - 1

SLB	UCF 307
ASAHI	UCF 307
FYH	UCF 307
NSK	UCF 307
NTN	UCF 307 D 1

Figure MU 19
Medium Duty
 Flanged Units - Cast Housing
 Set Screws Type

1.3780 in	ID	35.00 mm
3.9961 in	SB	101.50 mm

Group No. FU 0206 - 1

SLB	UCF X07
ASAHI	UCF X07
FYH	UCF X07
NSK	UCF X07
NTN	UCF X07 D 1
RHP	MSF 35
SEALMASTER	MSF - 307
SNR	MSF 35

Figure MU 16
Standard Duty
 Flanged Units - Cast Housing
 Adapter Type

1.3780 in	ID	35.00 mm
4.0157 in	SB	102.00 mm

Group No. FU 0207 - 1

SLB	UKF 208
ASAHI	UKF 208
FYH	UKF 208
NACHI	UKF 208
NSK	UKF 208
NTN	UKF 208 D 1

Figure MU 13
Standard Duty
 Flanged Cartridge Units - Cast Housing
 Eccentric Locking Collar Type, Set Screws Type

1.3780 in	ID	35.00 mm
4.3307 in	SB	110.00 mm

Group No. FU 0208 - 1

SLB	UCFC 207
ASAHI	UCFC 207
FYH	UCFC 207
INA	RMEY 35
NACHI	UCFC 207
NSK	UCFC 207
NTN	UCFC 207 D 1
RHP	FC 35

Group No. FU 0208 - 2

SLB	UELFC 207
INA	RME 35
NACHI	UGFC 207 + ER
NSK	EWFC 207
NTN	UELFC 207 D 1 W 3
RHP	FC 35 DEC

Group No. FU 0208 - 3

SLB	SAFC 207
INA	PME 35
RHP	FC 35 EC

Group No. FU 0208 - 4

SLB	SBFC 207
NACHI	BFC 207
NSK	UBFC 207 J
RHP	FC 35 A

Figure MU 17
Standard Duty
 Flanged Cartridge Units - Cast Housing
 Adapter Type

1.3780 in	ID	35.00 mm
4.7244 in	SB	120.00 mm

Group No. FU 0209 - 1

SLB	UKFC 208
FYH	UKFC 208
NACHI	UKFC 208
NSK	UKFC 208
NTN	UKFC 208 D 1

Figure MU 14
Standard Duty
 Two Bolts Flanged Units - Cast Housing
 Eccentric Locking Collar Type, Set Screws Type

1.3780 in	ID	35.00 mm
5.1181 in	SB	130.00 mm

Group No. FU 0210 - 1

SLB	UCFT 207
ASAHI	UCFT 207
LINK BELT	FX 3 - U 2 M 35 N
RHP	SFT 35
SNR	SFT 35

Group No. FU 0210 - 2

SLB	UELFT 207
NTN	UELFLU 207 D 1 W 3
RHP	SFT 35 DEC

Group No. FU 0210 - 3

SLB	SAFT 207
FAFNIR	VCJT - 35
RHP	SFT 35 EC
SNR	SFT 35 EC

Group No. FU 0210 - 4

SLB	SBFT 207
FAFNIR	SCJT - 35
RHP	SFT 35 A
SNR	SFT 35 A

Figure MU 15
Standard Duty
 Two Bolts Flanged Units - Cast Housing
 Eccentric Locking Collar Type, Set Screws Type

1.3780 in	ID	35.00 mm
5.1181 in	SB	130.00 mm

Group No. FU 0211 - 1

SLB	UCFL 207
ASAHI	UCFL 207
FYH	UCFL 207
INA	RCJTY 35
KOYO	UCFL 207 B
NACHI	UCFL 207
NSK	ULFL 207
NTN	UCFL 207 D 1
SEALMASTER	SFT - 207
SKF	FYT 35 TM

Group No. FU 0211 - 2

SLB	UELFL 207
FAFNIR	RCJT - 35
INA	RCJT 35
KOYO	GFFL 1106 MB
NACHI	UGFL 207 + ER
NSK	EWFL 207
NTN	UELFL 207 D 1 W 3
SKF	FYT 35 WM

Group No. FU 0211 - 3

SLB	SAFL 207
INA	PCJT 35
KOYO	GARAFL 106 MBA
SKF	FYT 35 FM

Group No. FU 0211 - 4

SLB	SBFL 207
ASAHI	BFL 207
INA	PCJTY 35
KOYO	PBFL 22 MJ
NACHI	BFL 207
NSK	UBFL 207 J

Figure MU 22
Heavy Duty
 Two Bolts Flanged Units - Cast Housing
 Set Screws Type

1.3780 in	ID	35.00 mm
5.5512 in	SB	141.00 mm

Group No. FU 0212 - 1

SLB	UCFL 307
ASAHI	UCFL 307
FYH	UCFL 307
NSK	UCFL 307
NTN	UCFL 307 D 1

Figure MU 18
Standard Duty
 Two Bolts Flanged Units - Cast Housing
 Adapter Type

1.3780 in	ID	35.00 mm
5.6693 in	SB	144.00 mm

Group No. FU 0213 - 1

SLB	UKFL 208
FYH	UKFL 208
NACHI	UKFL 208
NSK	UKFL 208
NTN	UKFL 208 D 1

Figure MU 20
Medium Duty
 Two Bolts Flanged Units - Cast Housing
 Set Screws Type

1.3780 in	ID	35.00 mm
5.6693 in	SB	144.00 mm

Group No. FU 0214 - 1

SLB	UCFL X07
ASAHI	UCFL X07
FYH	UCFL X07
NSK	UCFL X07
NTN	UCFL X07 D 1
RHP	MSFT 35
SEALMASTER	MSFT - 307

Figure MU 11
Standard Duty
 Flanged Units - Cast Housing
 Eccentric Locking Collar Type, Set Screws Type

1.3780 in	ID	35.00 mm
3.6220 in	SB	92.0 mm

Group No. FU 0215 - 1

SLB	UCFS 207
ASAHI	UCLF 207

FYH	SLF 207
LINK BELT	F 3 - U 223 N
RHP	SF 35
SNR	SF 35

Group No. FU 0215 - 2

SLB	UELFS 207
FAFNIR	RCJ - 35
NTN	UELFU 207 D 1 W 3
RHP	SF 35 DEC

Group No. FU 0215 - 3

SLB	SAFS 207
FAFNIR	VCJ - 35
RHP	SF 35 EC
SNR	SF 35 EC

Group No. FU 0215 - 4

SLB	SBFS 207
RHP	SF 35 A
SNR	SF 35 A

Figure MU 12
Standard Duty
 Flanged Units - Cast Housing
 Eccentric Locking Collar Type, Set Screws Type

1.4375 in	ID	36.51 mm
3.6220 in	SB	92.00 mm

Group No. FU 0216 - 1

SLB	UCF 207 - 23
ASAHI	UCF 207 - 23
BROWNING	VF 4 S - 223
FAG	FG 56207.107
FYH	UCF 207 - 23
KOYO	UCF 207 - 23
NACHI	UCF 207 - 23
NTN	UCF 207 - 107 D 1
SEALMASTER	SF - 23
SKF	FY 1 - 7/16 TM

Group No. FU 0216 - 2

SLB	UELF 207 - 23
INA	RCJ 1 7/16"
KOYO	GFF 1107 B
NACHI	UGF 207 - 23 + ER
NTN	UELF 207 - 107 D 1 W 3
SKF	FY 1 - 7/16 WM

Group No. FU 0216 - 3

SLB	SAF 207 - 23
BROWNING	VF 4 E - 123
FAG	FG 16208.108
INA	PCJ 1 7/16"
KOYO	GARAF 107 A
SKF	FY 1 - 7/16 FM

Group No. FU 0216 - 4

SLB	SBF 207 - 23
ASAHI	BF 207 - 23
BROWNING	VF 4 S - 123
INA	PCJY
NACHI	BF 207 - 23

Figure MU 09
Standard Duty
 Two Bolts Flanged Units - Pressed Steel Housing
 Eccentric Locking Collar Type, Set Screws Type

1.4375 in	ID	36.51 mm
3.9370 in	SB	100.00 mm

Group No. FU 0217 - 1

SLB	SAPF 207 - 23
FAFNIR	RA - 1 - 7/16
FYH	SAPF 207 - 23
INA	RA 1 7/16"
KOYO	PF 107 A
LINK BELT	72 MSC 1 + 223
NACHI	KHPF 207 - 23 AE
NTN	AELPF 207 - 107 W 3
RHP	SLFE 1 7/16 EC
SKF	F 1 - 7/16 FM

Group No. FU 0217 - 2

SLB	SBPF 207 - 23
ASAHI	BPF 7 - 23
FYH	SBPF 207 - 23
NACHI	BPF 7 - 23
NTN	ASPF 207 - 107

Figure MU 10
Standard Duty
 Flanged Cartridge Units - Pressed Steel Housing
 Eccentric Locking Collar Type, Set Screws Type

1.4375 in	ID	36.51 mm
3.9370 in	SB	100.00 mm

Group No. FU 0218 - 1

SLB	SAPFL 207 - 23
FAFNIR	RAT - 1 - 7/16
INA	RAT 1 7/16"
NACHI	KHPFL 207 - 23 AE
NTN	AELPFL 207 - 107 W 3
SKF	FT 1 - 7/16 FM

Group No. FU 0218 - 2

SLB	SBPFL 207 - 23
ASAHI	BPFL 7 - 23
NACHI	BPFL 7 - 23
NTN	ASPFL 207 - 107

Figure MU 21 
Heavy Duty
Flanged Units - Cast Housing
Set Screws Type

1.4375 in	ID	36.51 mm
3.9370 in	SB	100.00 mm

Group No. FU 0219 - 1

SLB	UCF 307 - 23
NTN	UCF 307 - 107 D 1

Figure MU 19 
Medium Duty
Flanged Units - Cast Housing
Set Screws Type

1.4375 in	ID	36.51 mm
3.9961 in	SB	101.50 mm

Group No. FU 0220 - 1

SLB	UCF X07 - 23
ASAHI	UCF X07 - 23
BROWNING	VF 4 S - 323
FYH	UCF X07 - 23
NTN	UCF X07 - 107 D 1
RHP	MSF 1 7/16
SEALMASTER	MSF - 23
SKF	FYM 1 - 7/16 TM
SNR	MSF 1 7/16

Figure MU 13 
Standard Duty
Flanged Cartridge Units - Cast Housing
Eccentric Locking Collar Type, Set Screws Type

1.4375 in	ID	36.51 mm
4.3307 in	SB	110.00 mm

Group No. FU 0221 - 1

SLB	UCFC 207 - 23
ASAHI	UCFC 207 - 23
FYH	UCFC 207 - 23
NACHI	UCFC 207 - 23
NTN	UCFC 207 - 107 D 1
RHP	FC 1 7/16

Group No. FU 0221 - 2

SLB	UELFC 207 - 23
NACHI	UGFC 207 - 23 + ER
NTN	UELFC 207 - 107 D 1 W 3
RHP	FC 1 7/16 DEC

Group No. FU 0221 - 3

SLB	SAFC 207 - 23
RHP	FC 1 7/16 EC

Group No. FU 0221 - 4

SLB	SBFC 207 - 23
NACHI	BFC 207 - 23

Figure MU 14 
Standard Duty
Two Bolts Flanged Units - Cast Housing
Eccentric Locking Collar Type, Set Screws Type

1.4375 in	ID	36.51 mm
5.1181 in	SB	130.00 mm

Group No. FU 0222 - 1

SLB	UCFT 207 - 23
ASAHI	UCFT 207 - 23
LINK BELT	FX 3 - U 223 N
RHP	SFT 1 7/16

Group No. FU 0222 - 2

SLB	UELFT 207 - 23
BROWNING	VF 2 E - 223
LINK BELT	FX 3 - Y 223 N
NTN	UELFLU 207 - 107 D 1 W 3
RHP	SFT 1 7/16 DEC

Group No. FU 0222 - 3

SLB	SAFT 207 - 23
FAFNIR	VCJT - 1 - 7/16
LINK BELT	FX 3 - W 223 E
RHP	SFT 1 7/16 EC

Group No. FU 0222 - 4

SLB	SBFT 207 - 23
FAFNIR	SCJT - 1 - 7/16
LINK BELT	FX 3 - S 223 E

Figure MU 15 
Standard Duty
Two Bolts Flanged Units - Cast Housing
Eccentric Locking Collar Type, Set Screws Type

1.4375 in	ID	36.51 mm
5.1181 in	SB	130.00 mm

Group No. FU 0223 - 1

SLB	UCFL 207 - 23
ASAHI	UCFL 207 - 23
BROWNING	VF 2 S - 223
FYH	UCFL 207 - 23
KOYO	UCFL 207 - 23 B
NACHI	UCFL 207 - 23
NTN	UCFL 207 - 107 D 1
SEALMASTER	SFT - 23
SKF	FYT 1 - 7/16 TM

Group No. FU 0223 - 2

SLB	UELFL 207 - 23
FAFNIR	RCJT - 1 - 7/16

INA	RCJT 1 7/16"
KOYO	GFFL 1107 B
NACHI	UGFL 207 - 23 + ER
NTN	UELFL 207 - 107 D 1 W 3
SKF	FYT 1 - 7/16 WM

Group No. FU 0223 - 3

SLB	SAFL 207 - 23
BROWNING	VF 2 E - 123
INA	PCJT 1 7/16"
KOYO	GARAFL 107 BA
SKF	FYT 1 - 7/16 FM

Group No. FU 0223 - 4

SLB	SBFL 207 - 23
ASAHI	BFL 207 - 23
BROWNING	VF 2 S - 123
NACHI	BFL 207 - 23

Figure MU 22 
Heavy Duty
Two Bolts Flanged Units - Cast Housing
Set Screws Type

1.4375 in	ID	36.51 mm
5.5512 in	SB	141.00 mm

Group No. FU 0224 - 1

SLB	UCFL 307 - 23
NTN	UCFL 307 - 107 D 1

Figure MU 20 
Medium Duty
Two Bolts Flanged Units - Cast Housing
Set Screws Type

1.4375 in	ID	36.51 mm
5.6693 in	SB	144.00 mm

Group No. FU 0225 - 1

SLB	UCFL X07 - 23
ASAHI	UCFL X07 - 23
FYH	UCFL X07 - 23
NTN	UCFL X07 - 107 D 1
RHP	MSFT 1 7/16
SEALMASTER	MSFT - 23
SKF	FYTM 1 - 7/16 TM

Figure MU 11 
Standard Duty
Flanged Units - Cast Housing
Eccentric Locking Collar Type, Set Screws Type

1.4375 in	ID	36.51 mm
3.6220 in	SB	92.0 mm

Group No. FU 0226 - 1

SLB	UCFS 207 - 23
ASAHI	UCLF 207 - 23
FYH	SLF 207 - 23
LINK BELT	F 3 - U 223 N
RHP	SF 1 7/16

Group No. FU 0226 - 2

SLB	UELFS 207 - 23
BROWNING	VF 4 E - 223
FAFNIR	RCJ - 1 - 7/16
LINK BELT	F 3 - Y 223 N
NTN	UELFU 207 - 107 D 1 W 3
RHP	SF 1 7/16 DEC

Group No. FU 0226 - 3

SLB	SAFS 207 - 23
FAFNIR	VCJ - 1 - 7/16
LINK BELT	F 3 - W 223 E
RHP	SF 1 7/16 EC

Group No. FU 0226 - 4

SLB	SBFS 207 - 23
LINK BELT	F 3 - S 223 E

Figure MU 11

Standard Duty
Flanged Units - Cast Housing
Eccentric Locking Collar Type, Set Screws Type

1.5000 in	ID	38.10 mm
3.9961 in	SB	101.50 mm

Group No. FU 0227 - 1

SLB	UCFS 208 - 24
ASAHI	UCLF 208 - 24
FYH	SLF 208 - 24
LINK BELT	F 3 - U 224 N
RHP	SF 1 1/2

Group No. FU 0227 - 2

SLB	UELFS 208 - 24
BROWNING	VF 4 E - 224
FAFNIR	RCJ - 1 - 1/2
LINK BELT	F 3 - Y 224 N
NTN	UELFU 208 - 108 D 1 W 3
RHP	SF 1 1/2 DEC

Group No. FU 0227 - 3

SLB	SAFS 208 - 24
FAFNIR	VCJ - 1 - 1/2
LINK BELT	F 3 - W 224 E
RHP	SF 1 1/2 EC

Group No. FU 0227 - 4

SLB	SBFS 208 - 24
LINK BELT	F 3 - S 224 E
RHP	SF 1 1/2 A

Figure MU 12

Standard Duty
Flanged Units - Cast Housing
Eccentric Locking Collar Type, Set Screws Type

1.5000 in	ID	38.10 mm
4.0157 in	SB	102.00 mm

Group No. FU 0228 - 1

SLB	UCF 208 - 24
ASAHI	UCF 208 - 24
BROWNING	VF 4 S - 224
FAG	FG 56208.108
FYH	UCF 208 - 24
INA	RCJY 1 1/2"
KOYO	UCF 208 - 24 B
NACHI	UCF 208 - 24
NSK	UCF 208 - 24 S
NTN	UCF 208 - 108 D 1
SEALMASTER	SF - 24
SKF	FY 1 - 1/2 TM

Group No. FU 0228 - 2

SLB	UELF 208 - 24
INA	RCJ 1 1/2"
NACHI	UGF 208 - 24 + ER
NTN	UELF 208 - 108 D 1 W 3
SKF	FY 1 - 1/2 WM

Group No. FU 0228 - 3

SLB	SAF 208 - 24
INA	PCJ 1 1/2"
KOYO	GARAF 108 A
SKF	FY 1 - 1/2 FM

Figure MU 19

Medium Duty
Flanged Units - Cast Housing
Set Screws Type

1.5000 in	ID	38.10 mm
4.1339 in	SB	105.00 mm

Group No. FU 0229 - 1

SLB	UCF X08 - 24
ASAHI	UCF X08 - 24
BROWNING	VF 4 S - 324
FYH	UCF X08 - 24
INA	RCJY 1 1/2" - MP
NTN	UCF X08 - 108 D 1
RHP	MSF 1 1/2
SEALMASTER	MSF - 24
SKF	FYM 1 - 1/2 TM
SNR	MSF 1 1/2

Figure MU 21

Heavy Duty
Flanged Units - Cast Housing
Set Screws Type

1.5000 in	ID	38.10 mm
4.4094 in	SB	112.00 mm

Group No. FU 0230 - 1

SLB	UCF 308 - 24
ASAHI	UCF 308 - 24
FYH	UCF 308 - 24
NSK	UCF 308 - 24 S
NTN	UCF 308 - 108 D 1

Figure MU 13

Standard Duty
Flanged Cartridge Units - Cast Housing
Eccentric Locking Collar Type, Set Screws Type

1.5000 in	ID	38.10 mm
4.7244 in	SB	120.00 mm

Group No. FU 0231 - 1

SLB	UCFC 208 - 24
ASAHI	UCFC 208 - 24
FYH	UCFC 208 - 24
INA	RMEY 1 1/2"
NACHI	UCFC 208 - 24
NSK	UCFC 208 - 24 S
NTN	UCFC 208 - 108 D 1
RHP	FC 1 1/2

Group No. FU 0231 - 2

SLB	UELFC 208 - 24
NACHI	UGFC 208 - 24 + ER
NTN	UELFC 208 - 108 D 1 W 3
RHP	FC 1 1/2 DEC

Group No. FU 0231 - 3

SLB	SAFC 208 - 24
RHP	FC 1 1/2 EC

Group No. FU 0231 - 4

SLB	SBFC 208 - 24
RHP	FC 1 1/2 A

Figure MU 14

Standard Duty
Two Bolts Flanged Units - Cast Housing
Eccentric Locking Collar Type, Set Screws Type

1.5000 in	ID	38.10 mm
5.6496 in	SB	143.50 mm

Group No. FU 0232 - 1

SLB	UCFT 208 - 24
ASAHI	UCFT 208 - 24
LINK BELT	FX 3 - U 224 N
RHP	SFT 1 1/2

Group No. FU 0232 - 2

SLB	UELFT 208 - 24
BROWNING	VF 2 E - 224

LINK BELT	FX 3 - Y 224 N
NTN	UELFLU 208 - 108 D 1 W 3
RHP	SFT 1 1/2 DEC

Group No. FU 0232 - 3

SLB	SAFT 208 - 24
FAFNIR	VCJT - 1 - 1/2
LINK BELT	FX 3 - W 224 E
RHP	SFT 1 1/2 EC

Group No. FU 0232 - 4

SLB	SBFT 208 - 24
FAFNIR	SCJT - 1 - 1/2
LINK BELT	FX 3 - S 224 E
RHP	SFT 1 1/2 A

Figure MU 15

Standard Duty
Two Bolts Flanged Units - Cast Housing
Eccentric Locking Collar Type, Set Screws Type

1.5000 in	ID	38.10 mm
5.6693 in	SB	144.00 mm

Group No. FU 0233 - 1

SLB	UCFL 208 - 24
ASAHI	UCFL 208 - 24
BROWNING	VF 2 S - 224
FYH	UCFL 208 - 24
INA	RCJTY 1 1/2"
KOYO	UCFL 207 - 24 B
NACHI	UCFL 208 - 24
NSK	ULFL 208 - 24 S
NTN	UCFL 208 - 108 D 1
SEALMASTER	SFT - 24
SKF	FYT 1 - 1/2 TM

Group No. FU 0233 - 2

SLB	UELFL 208 - 24
FAFNIR	RCJT - 1 - 1/2
INA	RCJT 1 1/2"
NACHI	UGFL 208 - 24 + ER
NTN	UELFL 208 - 108 D 1 W 3
SKF	FYT 1 - 1/2 WM

Group No. FU 0233 - 3

SLB	SAFL 208 - 24
INA	PCJT 1 1/2"
KOYO	GARAFL 108 BA
SKF	FYT 1 - 1/2 FM

Figure MU 20

Medium Duty
Two Bolts Flanged Units - Cast Housing
Set Screws Type

1.5000 in	ID	38.10 mm
5.8268 in	SB	148.00 mm

Group No. FU 0234 - 1

SLB	UCFL X08 - 24
ASAHI	UCFL X08 - 24
FYH	UCFL X08 - 24
NTN	UCF L X08 - 108 D 1
RHP	MSFT 1 1/2
SEALMASTER	MSFT - 24
SKF	FYTM 1 - 1/2 TM

Figure MU 22

Heavy Duty
Two Bolts Flanged Units - Cast Housing
Set Screws Type

1.5000 in	ID	38.10 mm
6.2205 in	SB	158.00 mm

Group No. FU 0235 - 1

SLB	UCFL 308 - 24
ASAHI	UCFL 308 - 24
FYH	UCFL 308 - 24
NSK	UCFL 308 - 24 S
NTN	UCFL 308 - 108 D 1

Figure MU 11

Standard Duty
Flanged Units - Cast Housing
Eccentric Locking Collar Type, Set Screws Type

1.5625 in	ID	39.69 mm
3.9961 in	SB	101.50 mm

Group No. FU 0236 - 1

SLB	UCFS 208 - 25
ASAHI	UCLF 208 - 25
FYH	SLF 208 - 25

Group No. FU 0236 - 2

SLB	UELFS 208 - 25
FAFNIR	RCJ - 1 - 9/16
NTN	UELFLU 208 - 109 D 1 W 3

Group No. FU 0236 - 3

SLB	SAFS 208 - 25
FAFNIR	VCJ - 1 - 9/16

Figure MU 12

Standard Duty
Flanged Units - Cast Housing
Eccentric Locking Collar Type, Set Screws Type

1.5625 in	ID	39.69 mm
4.0157 in	SB	102.00 mm

Group No. FU 0237 - 1

SLB	UCF 208 - 25
ASAHI	UCF 208 - 25

FYH	UCF 208 - 25
KOYO	UCF 208 - 25 B
NACHI	UCF 208 - 25
NTN	UCF 208 - 109 D 1
SEALMASTER	SF - 25
SKF	FY 1 - 9/16 TM

Group No. FU 0237 - 2

SLB	UELFL 208 - 25
NACHI	UGF 208 - 25 + ER
NTN	UELFL 208 - 109 D 1 W 3
SKF	FY 1 - 9/16 WM

Group No. FU 0237 - 3

SLB	SAF 208 - 25
FAG	FG 16208
KOYO	GARAF 109 A
SKF	FY 1 - 9/16 FM

Figure MU 19

Medium Duty
Flanged Units - Cast Housing
Set Screws Type

1.5625 in	ID	39.69 mm
4.1339 in	SB	105.00 mm

Group No. FU 0238 - 1

SLB	UCF X08 - 25
NTN	UCF X08 - 109 D 1

Figure MU 21

Heavy Duty
Flanged Units - Cast Housing
Set Screws Type

1.5625 in	ID	39.69 mm
4.4094 in	SB	112.00 mm

Group No. FU 0239 - 1

SLB	UCF 308 - 25
NTN	UCF 308 - 109 D 1

Figure MU 13

Standard Duty
Flanged Cartridge Units - Cast Housing
Eccentric Locking Collar Type, Set Screws Type

1.5625 in	ID	39.69 mm
4.7244 in	SB	120.00 mm

Group No. FU 0240 - 1

SLB	UCFC 208 - 25
ASAHI	UCFC 208 - 25
FYH	UCFC 208 - 25
NACHI	UCFC 208 - 25
NTN	UCFC 208 - 109 D 1

Group No. FU 0240 - 2	
SLB	UELFC 208 - 25
NACHI	UGFC 208 - 25 + ER
NTN	UELFC 208 - 109 D 1 W 3

Figure MU 14 
Standard Duty
Two Bolts Flanged Units - Cast Housing
Eccentric Locking Collar Type, Set Screws Type

1.5625 in	ID	39.69 mm
5.6496 in	SB	143.50 mm

Group No. FU 0241 - 1	
SLB	UCFT 208 - 25
ASAHI	UCFT 208 - 25

Group No. FU 0241 - 2	
SLB	UELFT 208 - 25
NTN	UELFLU 208 - 109 D 1 W 3

Group No. FU 0241 - 3	
SLB	SAFT 208 - 25
FAFNIR	VCJT - 1 - 9/16

Figure MU 15 
Standard Duty
Two Bolts Flanged Units - Cast Housing
Eccentric Locking Collar Type, Set Screws Type

1.5625 in	ID	39.69 mm
5.6693 in	SB	144.00 mm

Group No. FU 0242 - 1	
SLB	UCFL 208 - 25
ASAHI	UCFL 208 - 25
FYH	UCFL 208 - 25
KOYO	UCFL 207 - 25 B
NACHI	UCFL 208 - 25
NTN	UCFL 208 - 109 D 1
SEALMASTER	SFT - 25
SKF	FYT 1 - 9/16 TM

Group No. FU 0242 - 2	
SLB	UELFL 208 - 25
NACHI	UGFL 208 - 25 + ER
NTN	UELFL 208 - 109 D 1 W 3
SKF	FYT 1 - 9/16 WM

Group No. FU 0242 - 3	
SLB	SAFL 208 - 25
KOYO	GARAF 109 BA
SKF	FYT 1 - 9/16 FM

Figure MU 20 
Medium Duty
Two Bolts Flanged Units - Cast Housing
Set Screws Type

1.5625 in	ID	39.69 mm
5.8268 in	SB	148.00 mm

Group No. FU 0243 - 1	
SLB	UCFL X08 - 25
NTN	UCFL X08 - 109 D 1

Figure MU 22 
Heavy Duty
Two Bolts Flanged Units - Cast Housing
Set Screws Type

1.5625 in	ID	39.69 mm
6.2205 in	SB	158.00 mm

Group No. FU 0244 - 1	
SLB	UCFL 308 - 25
NTN	UCFL 308 - 109 D 1

Figure MU 11 
Standard Duty
Flanged Units - Cast Housing
Eccentric Locking Collar Type, Set Screws Type

1.5748 in	ID	40.00 mm
3.9961 in	SB	101.50 mm

Group No. FU 0245 - 1	
SLB	UCFS 208
ASAHI	UCLF 208
FYH	SLF 208
LINK BELT	F 3 - U 2 M 40 N
RHP	SF 40
SNR	SF 40

Group No. FU 0245 - 2	
SLB	UELFS 208
FAFNIR	RCJ - 40
NTN	UELFU 208 D 1 W 3
RHP	SF 40 DEC

Group No. FU 0245 - 3	
SLB	SAFS 208
FAFNIR	VCJ - 40
RHP	SF 40 EC
SNR	SF 40 EC

Group No. FU 0245 - 4	
SLB	SBFS 208
RHP	SF 40 A
SNR	SF 40 A

Figure MU 12 
Standard Duty
Flanged Units - Cast Housing
Eccentric Locking Collar Type, Set Screws Type

1.5748 in	ID	40.00 mm
4.0157 in	SB	102.00 mm

Group No. FU 0246 - 1	
SLB	UCF 208
ASAHI	UCF 208
FAG	FG 56208
FYH	UCF 208
INA	RCJY 40
KOYO	UCF 208 B
NACHI	UCF 208
NSK	UCF 208
NTN	UCF 208 D 1
SEALMASTER	SF - 208
SKF	FY 40 TM

Group No. FU 0246 - 2	
SLB	UEL 208
INA	RCJ 40
NACHI	UGF 208 + ER
NSK	EW 208
NTN	UEL 208 D 1 W 3
SKF	FY 40 WM

Group No. FU 0246 - 3	
SLB	SAF 208
INA	PCJ 40
KOYO	GARAF 109 MBA
SKF	FY 40 FM

Group No. FU 0246 - 4	
SLB	SBF 208
INA	PCJY 40
KOYO	PBF 25 MJ

Figure MU 16 
Standard Duty
Flanged Units - Cast Housing
Adapter Type

1.5748 in	ID	40.00 mm
4.1339 in	SB	105.00 mm

Group No. FU 0247 - 1	
SLB	UKF 209
ASAHI	UKF 209
FYH	UKF 209
NACHI	UKF 209
NSK	UKF 209
NTN	UKF 209 D 1

Figure MU 19 
Medium Duty
Flanged Units - Cast Housing
Set Screws Type

1.5748 in	ID	40.00 mm
4.1339 in	SB	105.00 mm

Group No. FU 0248 - 1	
SLB	UCF X08
ASAHI	UCF X08
FYH	UCF X08
INA	RCJY 40 - MP
NSK	UCF X08
NTN	UCF X08 D 1
RHP	MSF 40
SEALMASTER	MSF - 308
SNR	MSF 40

Figure MU 21	
<i>Heavy Duty</i>	
<i>Flanged Units - Cast Housing</i>	
<i>Set Screws Type</i>	
1.5748 in	ID 40.00 mm
4.4094 in	SB 112.00 mm

Group No. FU 0249 - 1	
SLB	UCF 308
ASAHI	UCF 308
FYH	UCF 308
INA	RCJOY 40
NSK	UCF 308
NTN	UCF 308 D 1

Figure MU 13	
<i>Standard Duty</i>	
<i>Flanged Cartridge Units - Cast Housing</i>	
<i>Eccentric Locking Collar Type, Set Screws Type</i>	
1.5748 in	ID 40.00 mm
4.7244 in	SB 120.00 mm

Group No. FU 0250 - 1	
SLB	UCFC 208
ASAHI	UCFC 208
FYH	UCFC 208
INA	RMEY 40
NACHI	UCFC 208
NSK	UCFC 208
NTN	UCFC 208 D 1
RHP	FC 40

Group No. FU 0250 - 2	
SLB	UELFC 208
INA	RME 40
NACHI	UGFC 208 + ER
NSK	EWFC 208
NTN	UELFC 208 D 1 W 3
RHP	FC 40 DEC

Group No. FU 0250 - 3	
SLB	SAFC 208
INA	PME 40
RHP	FC 40 EC

Group No. FU 0250 - 4	
SLB	SBFC 208
RHP	FC 40 A

Figure MU 17	
<i>Standard Duty</i>	
<i>Flanged Cartridge Units - Cast Housing</i>	
<i>Adapter Type</i>	
1.5748 in	ID 40.00 mm
5.1969 in	SB 132.00 mm

Group No. FU 0251 - 1	
SLB	UKFC 209
FYH	UKFC 209
NACHI	UKFC 209
NSK	UKFC 209
NTN	UKFC 209 D 1

Figure MU 14	
<i>Standard Duty</i>	
<i>Two Bolts Flanged Units - Cast Housing</i>	
<i>Eccentric Locking Collar Type, Set Screws Type</i>	
1.5748 in	ID 40.00 mm
5.6496 in	SB 143.50 mm

Group No. FU 0252 - 1	
SLB	UCFT 208
ASAHI	UCFT 208
LINK BELT	FX 3 - U 2 M 40 N
RHP	SFT 40
SNR	SFT 40

Group No. FU 0252 - 2	
SLB	UELFT 208
NTN	UELFLU 208 D 1 W 3
RHP	SFT 40 DEC

Group No. FU 0252 - 3	
SLB	SAFT 208
FAFNIR	VCJT - 40
RHP	SFT 40 EC
SNR	SFT 40 EC

Group No. FU 0252 - 4	
SLB	SBFT 208
FAFNIR	SCJT - 40
RHP	SFT 40 A
SNR	SFT 40 A

Figure MU 15	
<i>Standard Duty</i>	
<i>Two Bolts Flanged Units - Cast Housing</i>	
<i>Eccentric Locking Collar Type, Set Screws Type</i>	
1.5748 in	ID 40.00 mm
5.6693 in	SB 144.00 mm

Group No. FU 0253 - 1	
SLB	UCFL 208
ASAHI	UCFL 208
FYH	UCFL 208
INA	RCJTY 40
KOYO	UCFL 208 B
NACHI	UCFL 208
NSK	ULFL 208
NTN	UCFL 208 D 1
SEALMASTER	SFT - 208
SKF	FYT 40 TM

Group No. FU 0253 - 2	
SLB	UELFL 208
FAFNIR	RCJT - 40
INA	RCJT 40
NACHI	UGFL 208 + ER
NSK	EWFL 208
NTN	UELFL 208 D 1 W 3
SKF	FYT 40 WM

Group No. FU 0253 - 3	
SLB	SAFL 208
INA	PCJT 40
KOYO	GARAFL 109 MBA
SKF	FYT 40 FM

Group No. FU 0253 - 4	
SLB	SBFL 208
INA	PCJTY 40
KOYO	PBFL 25 MJ

Figure MU 18	
<i>Standard Duty</i>	
<i>Two Bolts Flanged Units - Cast Housing</i>	
<i>Adapter Type</i>	
1.5748 in	ID 40.00 mm
5.8268 in	SB 148.00 mm

Group No. FU 0254 - 1	
SLB	UKFL 209
FYH	UKFL 209
NACHI	UKFL 209
NSK	UKFL 209
NTN	UKFL 209 D 1

Figure MU 20	
<i>Medium Duty</i>	
<i>Two Bolts Flanged Units - Cast Housing</i>	
<i>Set Screws Type</i>	
1.5748 in	ID 40.00 mm
5.8268 in	SB 148.00 mm

Group No. FU 0255 - 1	
SLB	UCFL X08
ASAHI	UCFL X08

FYH	UCFL X08
NSK	UCFL X08
NTN	UCFL X08 D 1
RHP	MSFT 40
SEALMASTER	MSFT - 308

Figure MU 22

Heavy Duty
Two Bolts Flanged Units - Cast Housing
Set Screws Type



1.5748 in	ID	40.00 mm
6.2205 in	SB	158.00 mm

Group No. FU 0256 - 1

SLB	UCFL 308
ASAHI	UCFL 308
FYH	UCFL 308
NSK	UCFL 308
NTN	UCFL 308 D 1

Figure MU 12

Standard Duty
Flanged Units - Cast Housing
Eccentric Locking Collar Type, Set Screws Type



1.6250 in	ID	41.28 mm
4.1339 in	SB	105.00 mm

Group No. FU 0257 - 1

SLB	UCF 209 - 26
ASAHI	UCF 209 - 26
BROWNING	VF 4 S - 226
FYH	UCF 209 - 26
KOYO	UCF 209 - 26
NACHI	UCF 209 - 26
NSK	UCF 209 - 26 S
NTN	UCF 209 - 110 D 1
SEALMASTER	SF - 26
SKF	FY 1 - 5/8 TM

Group No. FU 0257 - 2

SLB	UELF 209 - 26
INA	RCJ 1 5/8"
NACHI	UGF 209 - 26 + ER
NTN	UELF 209 - 110 D 1 W 3
SKF	FY 1 - 5/8 WM

Group No. FU 0257 - 3

SLB	SAF 209 - 26
KOYO	GARAF 110 A
SKF	FY 1 - 5/8 FM

Figure MU 19

Medium Duty
Flanged Units - Cast Housing
Set Screws Type



1.6250 in	ID	41.28 mm
4.3701 in	SB	111.00 mm

Group No. FU 0258 - 1

SLB	UCF X09 - 26
ASAHI	UCF X09 - 26
NTN	UCF X09 - 110 D 1

Figure MU 21

Heavy Duty
Flanged Units - Cast Housing
Set Screws Type



1.6250 in	ID	41.28 mm
4.9213 in	SB	125.00 mm

Group No. FU 0259 - 1

SLB	UCF 309 - 26
ASAHI	UCF 309 - 26
NSK	UCF 309 - 26 S
NTN	UCF 309 - 110 D 1

Figure MU 13

Standard Duty
Flanged Cartridge Units - Cast Housing
Eccentric Locking Collar Type, Set Screws Type



1.6250 in	ID	41.28 mm
5.1969 in	SB	132.00 mm

Group No. FU 0260 - 1

SLB	UCFC 209 - 26
ASAHI	UCFC 209 - 26
FYH	UCFC 209 - 26
NACHI	UCFC 209 - 26
NSK	UCFC 209 - 26 S
NTN	UCFC 209 - 110 D 1
RHP	FC 1 5/8

Group No. FU 0260 - 2

SLB	UELFC 209 - 26
NACHI	UGFC 209 - 26 + ER
NTN	UELFC 209 - 110 D 1 W 3
RHP	FC 1 5/8 DEC

Group No. FU 0260 - 3

SLB	SAFC 209 - 26
RHP	FC 1 5/8 EC

Figure MU 15

Standard Duty
Two Bolts Flanged Units - Cast Housing
Eccentric Locking Collar Type, Set Screws Type



1.6250 in	ID	41.28 mm
5.8268 in	SB	148.00 mm

Group No. FU 0261 - 1

SLB	UCFL 209 - 26
ASAHI	UCFL 209 - 26
BROWNING	VF 2 S - 226
FYH	UCFL 209 - 26
KOYO	UCFL 209 - 26 B
NACHI	UCFL 209 - 26
NSK	ULFL 209 - 26 S
NTN	UCFL 209 - 110 D 1
SEALMASTER	SFT - 26
SKF	FYT 1 - 5/8 TM

Group No. FU 0261 - 2

SLB	UELFL 209 - 26
FAFNIR	RCJT - 1 - 5/8
INA	RCJT 1 5/8"
NACHI	UGFL 209 - 26 + ER
NTN	UELFL 209 - 110 D 1 W 3
SKF	FYT 1 - 5/8 WM

Group No. FU 0261 - 3

SLB	SAFL 209 - 26
KOYO	GARAF 110 BA
SKF	FYT 1 - 5/8 FM

Figure MU 14

Standard Duty
Two Bolts Flanged Units - Cast Housing
Eccentric Locking Collar Type, Set Screws Type



1.6250 in	ID	41.28 mm
5.8465 in	SB	148.50 mm

Group No. FU 0262 - 1

SLB	UCFT 209 - 26
ASAHI	UCFT 209 - 26
LINK BELT	FX 3 - U 226 N
RHP	SFT 1 5/8

Group No. FU 0262 - 2

SLB	UELFT 209 - 26
BROWNING	VF 2 E - 226
LINK BELT	FX 3 - Y 226 N
NTN	UELFLU 209 - 110 D 1 W 3
RHP	SFT 1 5/8 DEC

Group No. FU 0262 - 3

SLB	SAFT 209 - 26
FAFNIR	VCJT - 1 - 5/8
LINK BELT	FX 3 - W 226 U
RHP	SFT 1 5/8 EC

Figure MU 20

Medium Duty
Two Bolts Flanged Units - Cast Housing
Set Screws Type



1.6250 in	ID	41.28 mm
6.1811 in	SB	157.00 mm

Group No. FU 0263 - 1		
SLB	UCFL X09 - 26	
ASAHI	UCFL X09 - 26	
NTN	UCFL X09 - 110 D 1	

Figure MU 22
Heavy Duty
 Two Bolts Flanged Units - Cast Housing
 Set Screws Type



1.6250 in	ID	41.28 mm
6.9685 in	SB	177.00 mm

Group No. FU 0264 - 1		
SLB	UCFL 309 - 26	
ASAHI	UCFL 309 - 26	
NSK	UCFL 309 - 26 S	
NTN	UCFL 309 - 110 D 1	

Figure MU 11
Standard Duty
 Flanged Units - Cast Housing
 Eccentric Locking Collar Type, Set Screws Type



1.6250 in	ID	41.28 mm
4.1339 in	SB	105.0 mm

Group No. FU 0265 - 1		
SLB	UCFS 209 - 26	
ASAHI	UCLF 209 - 26	
FYH	SLF 209 - 26	
LINK BELT	F 3 - U 226 N	
RHP	SF 1 5/8	

Group No. FU 0265 - 2		
SLB	UELFS 209 - 26	
BROWNING	VF 4 E - 226	
FAFNIR	RCJ - 1 - 5/8	
LINK BELT	F 3 - Y 226 N	
NTN	UELFU 209 - 110 D 1 W 3	
RHP	SF 1 5/8 DEC	

Group No. FU 0265 - 3		
SLB	SAFS 209 - 26	
FAFNIR	VCJ - 1 - 5/8	
LINK BELT	F 3 - W 226 U	
RHP	SF 1 5/8 EC	

Figure MU 12
Standard Duty
 Flanged Units - Cast Housing
 Eccentric Locking Collar Type, Set Screws Type



1.6875 in	ID	42.86 mm
4.1339 in	SB	105.00 mm

Group No. FU 0266 - 1		
SLB	UCF 209 - 27	
ASAHI	UCF 209 - 27	
BROWNING	VF 4 S - 227	
FYH	UCF 209 - 27	
KOYO	UCF 209 - 27	
NACHI	UCF 209 - 27	
NTN	UCF 209 - 111 D 1	
SEALMASTER	SF - 27	
SKF	FY 1 - 11/16 TM	

Group No. FU 0266 - 2		
SLB	UELF 209 - 27	
INA	RCJ 1 11/16"	
NACHI	UGF 209 - 27 + ER	
NTN	UELF 209 - 111 D 1 W 3	
SKF	FY 1 - 11/16 WM	

Group No. FU 0266 - 3		
SLB	SAF 209 - 27	
FAG	FG 16209.112	
KOYO	GARAF 111 A	
SKF	FY 1 - 11/16 FM	

Figure MU 19
Medium Duty
 Flanged Units - Cast Housing
 Set Screws Type



1.6875 in	ID	42.86 mm
4.3701 in	SB	111.00 mm

Group No. FU 0267 - 1		
SLB	UCF X09 - 27	
ASAHI	UCF X09 - 27	
BROWNING	VF 4 S - 327	
FYH	UCF X09 - 27	
NTN	UCF X09 - 111 D 1	
RHP	MSF 1 11/16	
SEALMASTER	MSF - 27	
SKF	FYM 1 - 11/16 TM	
SNR	MSF 1 11/16	

Figure MU 21
Heavy Duty
 Flanged Units - Cast Housing
 Set Screws Type



1.6875 in	ID	42.86 mm
4.9213 in	SB	125.00 mm

Group No. FU 0268 - 1		
SLB	UCF 309 - 27	
NTN	UCF 309 - 111 D 1	

Figure MU 13
Standard Duty
 Flanged Cartridge Units - Cast Housing
 Eccentric Locking Collar Type, Set Screws Type



1.6875 in	ID	42.86 mm
5.1969 in	SB	132.00 mm

Group No. FU 0269 - 1		
SLB	UCFC 209 - 27	
ASAHI	UCFC 209 - 27	
FYH	UCFC 209 - 27	
NACHI	UCFC 209 - 27	
NTN	UCFC 209 - 111 D 1	
RHP	FC 1 11/16	

Group No. FU 0269 - 2		
SLB	UELFC 209 - 27	
NACHI	UGFC 209 - 27 + ER	
NTN	UELFC 209 - 111 D 1 W 3	
RHP	FC 1 11/16 DEC	

Group No. FU 0269 - 3		
SLB	SAFC 209 - 27	
RHP	FC 1 11/16 EC	

Figure MU 15
Standard Duty
 Two Bolts Flanged Units - Cast Housing
 Eccentric Locking Collar Type, Set Screws Type



1.6875 in	ID	42.86 mm
5.8268 in	SB	148.00 mm

Group No. FU 0270 - 1		
SLB	UCFL 209 - 27	
ASAHI	UCFL 209 - 27	
BROWNING	VF 2 S - 227	
FYH	UCFL 209 - 27	
KOYO	UCFL 209 - 27 B	
NACHI	UCFL 209 - 27	
NTN	UCFL 209 - 111 D 1	
SEALMASTER	SFT - 27	
SKF	FYT 1 - 11/16 TM	

Group No. FU 0270 - 2		
SLB	UELFL 209 - 27	
FAFNIR	RCJT - 1 - 11/16	
INA	RCJT 1 11/16"	
NACHI	UGFL 209 - 27 + ER	
NTN	UELFL 209 - 111 D 1 W 3	
SKF	FYT 1 - 11/16 WM	

Group No. FU 0270 - 3		
SLB	SAFL 209 - 27	
KOYO	GARAF 111 BA	
SKF	FYT 1 - 11/16 FM	

Figure MU 14
Standard Duty
 Two Bolts Flanged Units - Cast Housing
 Eccentric Locking Collar Type, Set Screws Type



1.6875 in	ID	42.86 mm
5.8465 in	SB	148.50 mm

Group No. FU 0271 - 1

SLB	UCFT 209 - 27
ASAHI	UCFT 209 - 27
LINK BELT	FX 3 - U 227 N
RHP	SFT 1 11/16

Group No. FU 0271 - 2

SLB	UELFT 209 - 27
BROWNING	VF 2 E - 227
LINK BELT	FX 3 - Y 227 N
NTN	UELFU 209 - 111 D 1 W 3
RHP	SFT 1 11/16 DEC

Group No. FU 0271 - 3

SLB	SAFT 209 - 27
FAFNIR	VCJT - 1 - 11/16
LINK BELT	FX 3 - W 227 U
RHP	SFT 1 11/16 EC

Figure MU 20
Medium Duty
Two Bolts Flanged Units - Cast Housing
Set Screws Type

1.6875 in	ID	42.86 mm
6.1811 in	SB	157.00 mm

Group No. FU 0272 - 1

SLB	UCFL X09 - 27
ASAHI	UCFL X09 - 27
FYH	UCFL X09 - 27
NTN	UCFL X09 - 111 D 1
RHP	MSFT 1 11/16
SEALMASTER	MSFT - 27
SKF	FYTM 1 - 11/16 TM

Figure MU 22
Heavy Duty
Two Bolts Flanged Units - Cast Housing
Set Screws Type

1.6875 in	ID	42.86 mm
6.9685 in	SB	177.00 mm

Group No. FU 0273 - 1

SLB	UCFL 309 - 27
NTN	UCFL 309 - 111 D 1

Figure MU 11
Standard Duty
Flanged Units - Cast Housing
Eccentric Locking Collar Type, Set Screws Type

1.6875 in	ID	42.86 mm
4.1339 in	SB	105.0 mm

Group No. FU 0274 - 1

SLB	UCFS 209 - 27
ASAHI	UCLF 209 - 27
FYH	SLF 209 - 27
LINK BELT	F 3 - U 227 N
RHP	SF 1 11/16

Group No. FU 0274 - 2

SLB	UELFS 209 - 27
BROWNING	VF 4 E - 227
FAFNIR	RCJ - 1 - 11/16
LINK BELT	F 3 - Y 227 N
NTN	UELFU 209 - 111 D 1 W 3
RHP	SF 1 11/16 DEC

Group No. FU 0274 - 3

SLB	SAFS 209 - 27
FAFNIR	VCJ - 1 - 11/16
LINK BELT	F 3 - W 227 U
RHP	SF 1 11/16 EC

Figure MU 12
Standard Duty
Flanged Units - Cast Housing
Eccentric Locking Collar Type, Set Screws Type

1.7500 in	ID	44.45 mm
4.1339 in	SB	105.00 mm

Group No. FU 0275 - 1

SLB	UCF 209 - 28
ASAHI	UCF 209 - 28
BROWNING	VF 4 S - 228
FAG	FG 56209.112
FYH	UCF 209 - 28
INA	RCJY 1 3/4"
KOYO	UCF 209 - 28
NACHI	UCF 209 - 28
NSK	UCF 209 - 28 S
NTN	UCF 209 - 112 D 1
SEALMASTER	SF - 28
SKF	FY 1 - 3/4 TM

Group No. FU 0275 - 2

SLB	UELF 209 - 28
INA	RCJ 1 3/4"
NACHI	UGF 209 - 28 + ER
NTN	UELF 209 - 112 D 1 W 3
SKF	FY 1 - 3/4 WM

Group No. FU 0275 - 3

SLB	SAF 209 - 28
FAG	FG16209
INA	PCJ 1 3/4"
KOYO	GARAF 112 A
SKF	FY 1 - 3/4 FM

Figure MU 19
Medium Duty
Flanged Units - Cast Housing
Set Screws Type

1.7500 in	ID	44.45 mm
4.3701 in	SB	111.00 mm

Group No. FU 0276 - 1

SLB	UCF X09 - 28
ASAHI	UCF X09 - 28
BROWNING	VF 4 S - 328
FYH	UCF X09 - 28
INA	RCJY 1 3/4" - MP
NTN	UCF X09 - 112 D 1
RHP	MSF 1 3/4
SEALMASTER	MSF - 28
SKF	FYM 1 - 3/4 TM
SNR	MSF 1 3/4

Figure MU 21
Heavy Duty
Flanged Units - Cast Housing
Set Screws Type

1.7500 in	ID	44.45 mm
4.9213 in	SB	125.00 mm

Group No. FU 0277 - 1

SLB	UCF 309 - 28
ASAHI	UCF 309 - 28
FYH	UCF 309 - 28
NSK	UCF 309 - 28 S
NTN	UCF 309 - 112 D 1

Figure MU 13
Standard Duty
Flanged Cartridge Units - Cast Housing
Eccentric Locking Collar Type, Set Screws Type

1.7500 in	ID	44.45 mm
5.1969 in	SB	132.00 mm

Group No. FU 0278 - 1

SLB	UCFC 209 - 28
ASAHI	UCFC 209 - 28
FYH	UCFC 209 - 28
INA	RMEY 1 3/4"
NACHI	UCFC 209 - 28
NSK	UCFC 209 - 28 S
NTN	UCFC 209 - 112 D 1
RHP	FC 1 3/4

Group No. FU 0278 - 2

SLB	UELFC 209 - 28
NACHI	UGFC 209 - 28 + ER
NTN	UELFC 209 - 112 D 1 W 3
RHP	FC 1 3/4 DEC

Group No. FU 0278 - 3	
SLB	SAFC 209 - 28
RHP	FC 1 3/4 EC

Figure MU 15 
Standard Duty
 Two Bolts Flanged Units - Cast Housing
 Eccentric Locking Collar Type, Set Screws Type

1.7500 in	ID	44.45 mm
5.8268 in	SB	148.00 mm

Group No. FU 0279 - 1	
SLB	UCFL 209 - 28
ASAHI	UCFL 209 - 28
BROWNING	VF 2 S - 228
FYH	UCFL 209 - 28
INA	RCJTY 1 3/4"
KOYO	UCFL 209 - 28 B
NACHI	UCFL 209 - 28
NSK	ULFL 209 - 28 S
NTN	UCFL 209 - 112 D 1
SEALMASTER	SFT - 28
SKF	FYT 1 - 3/4 TM

Group No. FU 0279 - 2	
SLB	UELFL 209 - 28
FAFNIR	RCJT - 1 - 3/4
INA	RCJT 1 3/4"
NACHI	UGFL 209 - 28 + ER
NTN	UELFL 209 - 112 D 1 W 3
SKF	FYT 1 - 3/4 WM

Group No. FU 0279 - 3	
SLB	SAFL 209 - 28
INA	PCJT 1 3/4"
KOYO	GARAFL 112 BA
SKF	FYT 1 - 3/4 FM

Figure MU 14 
Standard Duty
 Two Bolts Flanged Units - Cast Housing
 Eccentric Locking Collar Type, Set Screws Type

1.7500 in	ID	44.45 mm
5.8465 in	SB	148.50 mm

Group No. FU 0280 - 1	
SLB	UCFT 209 - 28
ASAHI	UCFT 209 - 28
LINK BELT	FX 3 - U 228 N
RHP	SFT 1 3/4

Group No. FU 0280 - 2	
SLB	UELFT 209 - 28
BROWNING	VF 2 E - 228
LINK BELT	FX 3 - Y 228 N
NTN	UELFLU 209 - 112 D 1 W 3
RHP	SFT 1 3/4 DEC

Group No. FU 0280 - 3	
SLB	SAFT 209 - 28
FAFNIR	VCJT - 1 - 3/4
LINK BELT	FX 3 - W 228 U
RHP	SFT 1 3/4 EC

Figure MU 20 
Medium Duty
 Two Bolts Flanged Units - Cast Housing
 Set Screws Type

1.7500 in	ID	44.45 mm
6.1811 in	SB	157.00 mm

Group No. FU 0281 - 1	
SLB	UCFL X09 - 28
ASAHI	UCFL X09 - 28
FYH	UCFL X09 - 28
NTN	UCFL X09 - 112 D 1
RHP	MSFT 1 3/4
SEALMASTER	MSFT - 28
SKF	FYTM 1 - 3/4 TM

Figure MU 22 
Heavy Duty
 Two Bolts Flanged Units - Cast Housing
 Set Screws Type

1.7500 in	ID	44.45 mm
6.9685 in	SB	177.00 mm

Group No. FU 0282 - 1	
SLB	UCFL 309 - 28
ASAHI	UCFL 309 - 28
FYH	UCFL 309 - 28
NSK	UCFL 309 - 28 S
NTN	UCFL 309 - 112 D 1

Figure MU 11 
Standard Duty
 Flanged Units - Cast Housing
 Eccentric Locking Collar Type, Set Screws Type

1.7500 in	ID	44.45 mm
4.1339 in	SB	105.0 mm

Group No. FU 0283 - 1	
SLB	UCFS 209 - 28
ASAHI	UCLF 209 - 28
FYH	SLF 209 - 28
LINK BELT	F 3 - U 228 N
RHP	SF 1 3/4

Group No. FU 0283 - 2	
SLB	UELFS 209 - 28
BROWNING	VF 4 E - 228
FAFNIR	RCJ - 1 - 3/4
LINK BELT	F 3 - Y 228 N

NTN	UELFLU 209 - 112 D 1 W 3
RHP	SF 1 3/4 DEC

Group No. FU 0283 - 3	
SLB	SAFS 209 - 28
FAFNIR	VCJ - 1 - 3/4
LINK BELT	F 3 - W 228 U
RHP	SF 1 3/4 EC

Figure MU 12 
Standard Duty
 Flanged Units - Cast Housing
 Eccentric Locking Collar Type, Set Screws Type

1.7717 in	ID	45.00 mm
4.1339 in	SB	105.00 mm

Group No. FU 0284 - 1	
SLB	UCF 209
ASAHI	UCF 209
FAG	FG 56209
FYH	UCF 209
INA	RCJY 45
KOYO	UCF 209
NACHI	UCF 209
NSK	UCF 209
NTN	UCF 209 D 1
SEALMASTER	SF - 209
SKF	FY 45 TM

Group No. FU 0284 - 2	
SLB	UELFL 209
INA	RCJ 45
NACHI	UGF 209 + ER
NSK	EWFL 209
NTN	UELFL 209 D 1 W 3
SKF	FY 45 WM

Group No. FU 0284 - 3	
SLB	SAF 209
INA	PCJ 45
KOYO	GARAFL 112 MA
SKF	FY 45 FM

Figure MU 16 
Standard Duty
 Flanged Units - Cast Housing
 Adapter Type

1.7717 in	ID	45.00 mm
4.3701 in	SB	111.00 mm

Group No. FU 0285 - 1	
SLB	UKF 210
ASAHI	UKF 210
FYH	UKF 210
NACHI	UKF 210
NSK	UKF 210
NTN	UKF 210 D 1

Figure MU 19 

Medium Duty
Flanged Units - Cast Housing
Set Screws Type

1.7717 in	ID	45.00 mm
4.3701 in	SB	111.00 mm

Group No. FU 0286 - 1

SLB	UCF X09
ASAHI	UCF X09
FYH	UCF X09
INA	RCJY 45 - MP
NSK	UCF X09
NTN	UCF X09 D 1
RHP	MSF 45
SEALMASTER	MSF - 309
SNR	MSF 45

Group No. FU 0288 - 3

SLB	SAFC 209
INA	PME 45
RHP	FC 45 EC

1.7717 in	ID	45.00 mm
5.8465 in	SB	148.50 mm

Group No. FU 0291 - 1

SLB	UCFT 209
ASAHI	UCFT 209
LINK BELT	FX 3 - U 2 M 45 N
RHP	SFT 45
SNR	SFT 45

Figure MU 17 

Standard Duty
Flanged Cartridge Units - Cast Housing
Adapter Type

1.7717 in	ID	45.00 mm
5.4331 in	SB	138.00 mm

Group No. FU 0291 - 2

SLB	UELFT 209
NTN	UELFLU 209 D 1 W 3
RHP	SFT 45 DEC

Group No. FU 0289 - 1

SLB	UKFC 210
FYH	UKFC 210
NACHI	UKFC 210
NSK	UKFC 210
NTN	UKFC 210 D 1

Group No. FU 0291 - 3

SLB	SAFT 209
FAFNIR	VCJT - 45
RHP	SFT 45 EC
SNR	SFT 45 EC

Figure MU 21 

Heavy Duty
Flanged Units - Cast Housing
Set Screws Type

1.7717 in	ID	45.00 mm
4.9213 in	SB	125.00 mm

Group No. FU 0287 - 1

SLB	UCF 309
ASAHI	UCF 309
FYH	UCF 309
NSK	UCF 309
NTN	UCF 309 D 1

Figure MU 15 

Standard Duty
Two Bolts Flanged Units - Cast Housing
Eccentric Locking Collar Type, Set Screws Type

1.7717 in	ID	45.00 mm
5.8268 in	SB	148.00 mm

Figure MU 18 

Standard Duty
Two Bolts Flanged Units - Cast Housing
Adapter Type

1.7717 in	ID	45.00 mm
6.1811 in	SB	157.00 mm

Group No. FU 0290 - 1

SLB	UCFL 209
ASAHI	UCFL 209
FYH	UCFL 209
INA	RCJTY 45
KOYO	UCFL 209 B
NACHI	UCFL 209
NSK	ULFL 209
NTN	UCFL 209 D 1
SEALMASTER	SFT - 209
SKF	FYT 45 TM

Group No. FU 0292 - 1

SLB	UKFL 210
FYH	UKFL 210
NACHI	UKFL 210
NSK	UKFL 210
NTN	UKFL 210 D 1

Figure MU 13 

Standard Duty
Flanged Cartridge Units - Cast Housing
Eccentric Locking Collar Type, Set Screws Type

1.7717 in	ID	45.00 mm
5.1969 in	SB	132.00 mm

Group No. FU 0288 - 1

SLB	UCFC 209
ASAHI	UCFC 209
FYH	UCFC 209
INA	RMEY 45
NACHI	UCFC 209
NSK	UCFC 209
NTN	UCFC 209 D 1
RHP	FC 45

Group No. FU 0288 - 2

SLB	UELFC 209
INA	RME 45
NACHI	UGFC 209 + ER
NSK	EWFC 209
NTN	UELFC 209 D 1 W 3
RHP	FC 45 DEC

Group No. FU 0290 - 2

SLB	UELFL 209
FAFNIR	RCJT - 45
INA	RCJT 45
NACHI	UGFL 209 + ER
NSK	EWFL 209
NTN	UELFL 209 D 1 W 3
SKF	FYT 45 WM

Figure MU 20 

Medium Duty
Two Bolts Flanged Units - Cast Housing
Set Screws Type

1.7717 in	ID	45.00 mm
6.1811 in	SB	157.00 mm

Group No. FU 0290 - 3

SLB	SAFL 209
INA	PCJT 45
KOYO	GARAFL 112 MBA
SKF	FYT 45 FM

Group No. FU 0293 - 1

SLB	UCFL X09
ASAHI	UCFL X09
FYH	UCFL X09
NSK	UCFL X09
NTN	UCFL X09 D 1
RHP	MSFT 45
SEALMASTER	MSFT - 309

Figure MU 14 

Standard Duty
Two Bolts Flanged Units - Cast Housing
Eccentric Locking Collar Type, Set Screws Type

Figure MU 22 

Heavy Duty
Two Bolts Flanged Units - Cast Housing
Set Screws Type

1.7717 in	ID	45.00 mm
6.9685 in	SB	177.00 mm
Group No. FU 0294 - 1		
SLB	UCFL 309	
ASAHI	UCFL 309	
FYH	UCFL 309	
NSK	UCFL 309	
NTN	UCFL 309 D 1	

Figure MU 11
Standard Duty
Flanged Units - Cast Housing
Eccentric Locking Collar Type, Set Screws Type

1.7717 in	ID	45.00 mm
4.1339 in	SB	105.0 mm

Group No. FU 0295 - 1		
SLB	UCFS 209	
ASAHI	UCLF 209	
FYH	SLF 209	
LINK BELT	F 3 - U 2 M 45 N	
RHP	SF 45	
SNR	SF 45	

Group No. FU 0295 - 2		
SLB	UELFS 209	
FAFNIR	RCJ - 45	
NTN	UELFU 209 D 1 W 3	
RHP	SF 45 DEC	

Group No. FU 0295 - 3		
SLB	SAFS 209	
FAFNIR	VCJ - 45	
RHP	SF 45 EC	
SNR	SF 45 EC	

Figure MU 12
Standard Duty
Flanged Units - Cast Housing
Eccentric Locking Collar Type, Set Screws Type

1.8125 in	ID	46.04 mm
4.3701 in	SB	111.00 mm

Group No. FU 0296 - 1		
SLB	UCF 210 - 29	
NTN	UCF 210 - 113 D 1	
SEALMASTER	SF - 29	

Group No. FU 0296 - 2		
SLB	UELF 210 - 29	
NTN	UELF 210 - 113 D 1 W 3	

Figure MU 19
Medium Duty
Flanged Units - Cast Housing
Set Screws Type

1.8125 in	ID	46.04 mm
5.1181 in	SB	130.00 mm

Group No. FU 0297 - 1		
SLB	UCF X10 - 29	
NTN	UCF X10 - 113 D 1	

Figure MU 21
Heavy Duty
Flanged Units - Cast Housing
Set Screws Type

1.8125 in	ID	46.04 mm
5.1969 in	SB	132.00 mm

Group No. FU 0298 - 1		
SLB	UCF 310 - 29	
NTN	UCF 310 - 113 D 1	

Figure MU 13
Standard Duty
Flanged Cartridge Units - Cast Housing
Eccentric Locking Collar Type, Set Screws Type

1.8125 in	ID	46.04 mm
5.4331 in	SB	138.00 mm

Group No. FU 0299 - 1		
SLB	UCFC 210 - 29	
NTN	UCFC 210 - 113 D 1	

Group No. FU 0299 - 2		
SLB	UELFC 210 - 29	
NTN	UELFC 210 - 113 D 1 W 3	

Figure MU 14
Standard Duty
Two Bolts Flanged Units - Cast Housing
Eccentric Locking Collar Type, Set Screws Type

1.8125 in	ID	46.04 mm
6.1811 in	SB	157.00 mm

Group No. FU 0300 - 1		
SLB	UCFT 210 - 29	
FYH	UCFT 210 - 29	

Group No. FU 0300 - 2		
SLB	UELFT 210 - 29	
NTN	UELFLU 210 - 113 D 1 W 3	

Group No. FU 0300 - 3		
SLB	SAFT 210 - 29	
FAFNIR	VCJT - 1 - 13/16	

Figure MU 15
Standard Duty
Two Bolts Flanged Units - Cast Housing
Eccentric Locking Collar Type, Set Screws Type

1.8125 in	ID	46.04 mm
6.1811 in	SB	157.00 mm

Group No. FU 0301 - 1		
SLB	UCFL 210 - 29	
NTN	UCFL 210 - 113 D 1	
SEALMASTER	SFT - 29	

Group No. FU 0301 - 2		
SLB	UELFL 210 - 29	
FAFNIR	RCJT - 1 - 13/16	
NTN	UELFL 210 - 113 D 1 W 3	

Figure MU 20
Medium Duty
Two Bolts Flanged Units - Cast Housing
Set Screws Type

1.8125 in	ID	46.04 mm
7.2441 in	SB	184.00 mm

Group No. FU 0302 - 1		
SLB	UCFL X10 - 29	
NTN	UCFL X10 - 113 D 1	

Figure MU 22
Heavy Duty
Two Bolts Flanged Units - Cast Housing
Set Screws Type

1.8125 in	ID	46.04 mm
7.3622 in	SB	187.00 mm

Group No. FU 0303 - 1		
SLB	UCFL 310 - 29	
NTN	UCFL 310 - 113 D 1	

Figure MU 11
Standard Duty
Flanged Units - Cast Housing
Eccentric Locking Collar Type, Set Screws Type

1.8125 in	ID	46.04 mm
4.3701 in	SB	111.0 mm

Group No. FU 0304 - 1		
SLB	UCFS 210 - 29	
FYH	UCFS 210 - 29	

Group No. FU 0304 - 2		
SLB	UELFS 210 - 29	
FAFNIR	RCJ - 1 - 13/16	
NTN	UELFU 210 - 113 D 1 W 3	

Group No. FU 0304 - 3	
SLB	SAFS 210 - 29
FAFNIR	VCJ - 1 - 13/16

Figure MU 12
Standard Duty
Flanged Units - Cast Housing
Eccentric Locking Collar Type, Set Screws Type

1.8750 in	ID	47.63 mm
4.3701 in	SB	111.00 mm

Group No. FU 0305 - 1	
SLB	UCF 210 - 30
ASAHI	UCF 210 - 30
FYH	UCF 210 - 30
KOYO	UCF 210 - 30
NACHI	UCF 210 - 30
NSK	UCF 210 - 30 S
NTN	UCF 210 - 114 D 1
SEALMASTER	SF - 30
SKF	FY 1 - 7/8 TM

Group No. FU 0305 - 2	
SLB	UELF 210 - 30
NACHI	UGF 210 - 30 + ER
NTN	UELF 210 - 114 D 1 W 3
SKF	FY 1 - 7/8 WM

Group No. FU 0305 - 3	
SLB	SAF 210 - 30
KOYO	GARAF 114 A
SKF	FY 1 - 7/8 FM

Figure MU 19
Medium Duty
Flanged Units - Cast Housing
Set Screws Type

1.8750 in	ID	47.63 mm
5.1181 in	SB	130.00 mm

Group No. FU 0306 - 1	
SLB	UCF X10 - 30
ASAHI	UCF X10 - 30
NTN	UCF X10 - 114 D 1
RHP	MSF 1 7/8
SNR	MSF 1 7/8

Figure MU 21
Heavy Duty
Flanged Units - Cast Housing
Set Screws Type

1.8750 in	ID	47.63 mm
5.1969 in	SB	132.00 mm

Group No. FU 0307 - 1	
SLB	UCF 310 - 30
ASAHI	UCF 310 - 30
NSK	UCF 310 - 30 S
NTN	UCF 310 - 114 D 1

Figure MU 13
Standard Duty
Flanged Cartridge Units - Cast Housing
Eccentric Locking Collar Type, Set Screws Type

1.8750 in	ID	47.63 mm
5.4331 in	SB	138.00 mm

Group No. FU 0308 - 1	
SLB	UCFC 210 - 30
ASAHI	UCFC 210 - 30
FYH	UCFC 210 - 30
NACHI	UCFC 210 - 30
NSK	UCFC 210 - 30 S
NTN	UCFC 210 - 114 D 1
RHP	FC 1 7/8

Group No. FU 0308 - 2	
SLB	UELFC 210 - 30
NACHI	UGFC 210 - 30 + ER
NTN	UELFC 210 - 114 D 1 W 3
RHP	FC 1 7/8 DEC

Group No. FU 0308 - 3	
SLB	SAFC 210 - 30
RHP	FC 1 7/8 EC

Figure MU 14
Standard Duty
Two Bolts Flanged Units - Cast Housing
Eccentric Locking Collar Type, Set Screws Type

1.8750 in	ID	47.63 mm
6.1811 in	SB	157.00 mm

Group No. FU 0309 - 1	
SLB	UCFT 210 - 30
ASAHI	UCFT 210 - 30
RHP	SFT 1 7/8

Group No. FU 0309 - 2	
SLB	UELFT 210 - 30
NTN	UELFLU 210 - 114 D 1 W 3
RHP	SFT 1 7/8 DEC

Group No. FU 0309 - 3	
SLB	SAFT 210 - 30
FAFNIR	VCJT - 1 - 7/8
RHP	SFT 1 7/8 EC

Figure MU 15
Standard Duty
Two Bolts Flanged Units - Cast Housing
Eccentric Locking Collar Type, Set Screws Type

1.8750 in	ID	47.63 mm
6.1811 in	SB	157.00 mm

Group No. FU 0310 - 1	
SLB	UCFL 210 - 30
ASAHI	UCFL 210 - 30
FYH	UCFL 210 - 30
KOYO	UCFL 210 - 30
NACHI	UCFL 210 - 30
NSK	ULFL 210 - 30 S
NTN	UCFL 210 - 114 D 1
SEALMASTER	SFT - 30
SKF	FYT 1 - 7/8 TM

Group No. FU 0310 - 2	
SLB	UELFL 210 - 30
FAFNIR	RCJT - 1 - 7/8
NACHI	UGFL 210 - 30 + ER
NTN	UELFL 210 - 114 D 1 W 3
SKF	FYT 1 - 7/8 WM

Group No. FU 0310 - 3	
SLB	SAFL 210 - 30
KOYO	GARAF 114 A
SKF	FYT 1 - 7/8 FM

Figure MU 20
Medium Duty
Two Bolts Flanged Units - Cast Housing
Set Screws Type

1.8750 in	ID	47.63 mm
7.2441 in	SB	184.00 mm

Group No. FU 0311 - 1	
SLB	UCFL X10 - 30
ASAHI	UCFL X10 - 30
NTN	UCFL X10 - 114 D 1
RHP	MSFT 1 7/8

Figure MU 22
Heavy Duty
Two Bolts Flanged Units - Cast Housing
Set Screws Type

1.8750 in	ID	47.63 mm
7.3622 in	SB	187.00 mm

Group No. FU 0312 - 1	
SLB	UCFL 310 - 30
ASAHI	UCFL 310 - 30
NSK	UCFL 310 - 30 S
NTN	UCFL 310 - 114 D 1

Figure MU 11 
Standard Duty
Flanged Units - Cast Housing
Eccentric Locking Collar Type, Set Screws Type

1.8750 in	ID	47.63 mm
4.3701 in	SB	111.0 mm

Group No. FU 0313 - 1

SLB	UCFS 210 - 30
ASAHI	UCLF 210 - 30
FYH	SLF 210 - 30
RHP	SF 1 7/8

Group No. FU 0313 - 2

SLB	UELFS 210 - 30
FAFNIR	RCJ - 1 - 7/8
NTN	UELFU 210 - 114 D 1 W 3
RHP	SF 1 7/8 DEC

Group No. FU 0313 - 3

SLB	SAFS 210 - 30
FAFNIR	VCJ - 1 - 7/8
RHP	SF 1 7/8 EC

Figure MU 19 
Medium Duty
Flanged Units - Cast Housing
Set Screws Type

1.9375 in	ID	49.21 mm
5.1181 in	SB	130.00 mm

Group No. FU 0315 - 1

SLB	UCF X10 - 31
ASAHI	UCF X10 - 31
BROWNING	VF 4 S - 331
FYH	UCF X10 - 31
NTN	UCF X10 - 115 D 1
RHP	MSF 1 15/16
SEALMASTER	MSF - 31
SKF	FYM 1 - 15/16 TM
SNR	MSF 1 15/16

Figure MU 14 
Standard Duty
Two Bolts Flanged Units - Cast Housing
Eccentric Locking Collar Type, Set Screws Type

1.9375 in	ID	49.21 mm
6.1811 in	SB	157.00 mm

Group No. FU 0318 - 1

SLB	UCFT 210 - 31
ASAHI	UCFT 210 - 31
LINK BELT	FX 3 - U 231 N
RHP	SFT 1 15/16

Group No. FU 0318 - 2

SLB	UELFT 210 - 31
BROWNING	VF2E - 231
LINK BELT	FX 3 - Y 231 N
NTN	UELFU 210 - 115 D 1 W 3
RHP	SFT 1 15/16 DEC

Group No. FU 0318 - 3

SLB	SAFT 210 - 31
FAFNIR	VCJT - 1 - 15/16
LINK BELT	FX 3 - W 231 U
RHP	SFT 1 15/16 EC

Figure MU 12 
Standard Duty
Flanged Units - Cast Housing
Eccentric Locking Collar Type, Set Screws Type

1.9375 in	ID	49.21 mm
4.3701 in	SB	111.00 mm

Group No. FU 0314 - 1

SLB	UCF 210 - 31
ASAHI	UCF 210 - 31
BROWNING	VF 4 S - 231
FAG	FG 56210.115
FYH	UCF 210 - 31
INA	RCJY 1 15/16"
KOYO	UCF 210 - 31
NACHI	UCF 210 - 31
NTN	UCF 210 - 115 D 1
SEALMASTER	SF - 31
SKF	FY 1 - 15/16 TM

Group No. FU 0314 - 2

SLB	UELF 210 - 31
INA	RCJ 1 15/16"
NACHI	UGF 210 - 31 + ER
NTN	UELF 210 - 115 D 1 W 3
SKF	FY 1 - 15/16 WM

Group No. FU 0314 - 3

SLB	SAF 210 - 31
FAG	FG 16210
INA	PCJ 1 15/16"
KOYO	GARAF 115 A
SKF	FY 1 - 15/16 FM

Figure MU 21 
Heavy Duty
Flanged Units - Cast Housing
Set Screws Type

1.9375 in	ID	49.21 mm
5.1969 in	SB	132.00 mm

Group No. FU 0316 - 1

SLB	UCF 310 - 31
FYH	UCF 310 - 31
NTN	UCF 310 - 115 D 1

Figure MU 13 
Standard Duty
Flanged Cartridge Units - Cast Housing
Eccentric Locking Collar Type, Set Screws Type

1.9375 in	ID	49.21 mm
5.4331 in	SB	138.00 mm

Group No. FU 0317 - 1

SLB	UCFC 210 - 31
ASAHI	UCFC 210 - 31
FYH	UCFC 210 - 31
INA	RMEY 1 15/16"
NACHI	UCFC 210 - 31
NTN	UCFC 210 - 115 D 1
RHP	FC 1 15/16

Group No. FU 0317 - 2

SLB	UELFC 210 - 31
NACHI	UGFC 210 - 31 + ER
NTN	UELFC 210 - 115 D 1 W 3
RHP	FC 1 15/16 DEC

Group No. FU 0317 - 3

SLB	SAFC 210 - 31
RHP	FC 1 15/16 EC

Figure MU 15 
Standard Duty
Two Bolts Flanged Units - Cast Housing
Eccentric Locking Collar Type, Set Screws Type

1.9375 in	ID	49.21 mm
6.1811 in	SB	157.00 mm

Group No. FU 0319 - 1

SLB	UCFL 210 - 31
ASAHI	UCFL 210 - 31
BROWNING	VF 2 S - 231
FYH	UCFL 210 - 31
INA	RCJTY 1 15/16"
KOYO	UCFL 210 - 31
NACHI	UCFL 210 - 31
NTN	UCFL 210 - 115 D 1
SEALMASTER	SFT - 31
SKF	FYT 1 - 15/16 TM

Group No. FU 0319 - 2

SLB	UELFL 210 - 31
FAFNIR	RCJT - 1 - 15/16
INA	RCJT 1 15/16"
NACHI	UGFL 210 - 31 + ER
NTN	UELFL 210 - 115 D 1 W 3
SKF	FYT 1 - 15/16 WM

Group No. FU 0319 - 3

SLB	SAFL 210 - 31
INA	PCJT 1 15/16"
KOYO	GARAF 115 A
SKF	FYT 1 - 15/16 FM

Figure MU 20

Medium Duty
Two Bolts Flanged Units - Cast Housing
Set Screws Type



1.9375 in	ID	49.21 mm
7.2441 in	SB	184.00 mm

Group No. FU 0320 - 1

SLB	UCFL X10 - 31
ASAHI	UCFL X10 - 31
FYH	UCFL X10 - 31
NTN	UCFL X10 - 115 D 1
RHP	MSFT 1 15/16
SEALMASTER	MSFT - 31
SKF	FYTM 1 - 15/16 TM

Figure MU 22

Heavy Duty
Two Bolts Flanged Units - Cast Housing
Set Screws Type



1.9375 in	ID	49.21 mm
7.3622 in	SB	187.00 mm

Group No. FU 0321 - 1

SLB	UCFL 310 - 31
FYH	UCFL 310 - 31
NTN	UCFL 310 - 115 D 1

Figure MU 11

Standard Duty
Flanged Units - Cast Housing
Eccentric Locking Collar Type, Set Screws Type



1.9375 in	ID	49.21 mm
4.3701 in	SB	111.0 mm

Group No. FU 0322 - 1

SLB	UCFS 210 - 31
ASAHI	UCLF 210 - 31
FYH	SLF 210 - 31
LINK BELT	F 3 - U 231 N
RHP	SF 1 15/16

Group No. FU 0322 - 2

SLB	UELFS 210 - 31
BROWNING	VF 4 E - 231
FAFNIR	RCJ - 1 - 15/16
LINK BELT	F 3 - Y 231 N
NTN	UELFC 210 - 115 D 1 W 3
RHP	SF 1 15/16 DEC

Group No. FU 0322 - 3

SLB	SAFS 210 - 31
FAFNIR	VCJ - 1 - 15/16
LINK BELT	F 3 - W 231 U
RHP	SF 1 15/16 EC

Figure MU 12

Standard Duty
Flanged Units - Cast Housing
Eccentric Locking Collar Type, Set Screws Type



1.9685 in	ID	50.00 mm
4.3701 in	SB	111.00 mm

Group No. FU 0323 - 1

SLB	UCF 210
ASAHI	UCF 210
FAG	FG 56210
FYH	UCF 210
INA	RCJY 50
KOYO	UCF 210
NACHI	UCF 210
NSK	UCF 210
NTN	UCF 210 D 1
SEALMASTER	SF - 210
SKF	FY 50 TM

Group No. FU 0323 - 2

SLB	UELF 210
INA	RCJ 50
NACHI	UGF 210 + ER
NSK	EWFC 210
NTN	UELF 210 D 1 W 3
SKF	FY 50 WM

Group No. FU 0323 - 3

SLB	SAF 210
INA	PCJ 50
KOYO	GARAF 115 MA
SKF	FY 50 FM

Figure MU 16

Standard Duty
Flanged Units - Cast Housing
Adapter Type



1.9685 in	ID	50.00 mm
5.1181 in	SB	130.00 mm

Group No. FU 0324 - 1

SLB	UKF 211
ASAHI	UKF 211
FYH	UKF 211
NACHI	UKF 211
NSK	UKF 211
NTN	UKF 211 D 1

Figure MU 19

Medium Duty
Flanged Units - Cast Housing
Set Screws Type



1.9685 in	ID	50.00 mm
5.1181 in	SB	130.00 mm

Group No. FU 0325 - 1

SLB	UCF X10
ASAHI	UCF X10
FYH	UCF X10
INA	RCJY 50 - MP
NSK	UCF X10
NTN	UCF X10 D 1
RHP	MSF 50
SEALMASTER	MSF - 310
SNR	MSF 50

Figure MU 21

Heavy Duty
Flanged Units - Cast Housing
Set Screws Type



1.9685 in	ID	50.00 mm
5.1969 in	SB	132.00 mm

Group No. FU 0326 - 1

SLB	UCF 310
ASAHI	UCF 310
FYH	UCF 310
INA	RCJOY 50
NSK	UCF 310
NTN	UCF 310 D 1

Figure MU 13

Standard Duty
Flanged Cartridge Units - Cast Housing
Eccentric Locking Collar Type, Set Screws Type



1.9685 in	ID	50.00 mm
5.4331 in	SB	138.00 mm

Group No. FU 0327 - 1

SLB	UCFC 210
ASAHI	UCFC 210
FYH	UCFC 210
INA	RMEY 50
NACHI	UCFC 210
NSK	UCFC 210
NTN	UCFC 210 D 1
RHP	FC 50

Group No. FU 0327 - 2

SLB	UELFC 210
INA	RME 50
NACHI	UGFC 210 + ER
NSK	EWFC 210
NTN	UELFC 210 D 1 W 3
RHP	FC 50 DEC

Group No. FU 0327 - 3

SLB	SAFC 210
INA	PME 50
RHP	FC 50 EC

Figure MU 17
Standard Duty
Flanged Cartridge Units - Cast Housing
Adapter Type

1.9685 in	ID	50.00 mm
5.9055 in	SB	150.00 mm

Group No. FU 0328 - 1

SLB	UKFC 211
FYH	UKFC 211
NACHI	UKFC 211
NSK	UKFC 211
NTN	UKFC 211 D 1

Group No. FU 0330 - 2

SLB	UELFL 210
FAFNIR	RCJT - 50
INA	RCJT 50
NACHI	UGFL 210 + ER
NSK	EWFL 210
NTN	UELFL 210 D 1 W 3
SKF	FYT 50 WM

Group No. FU 0330 - 3

SLB	SAFL 210
INA	PCJT 50
KOYO	GARAFL 115 MA
SKF	FYT 50 FM

FYH	UCFL 310
NSK	UCFL 310
NTN	UCFL 310 D 1

Figure MU 11
Standard Duty
Flanged Units - Cast Housing
Eccentric Locking Collar Type, Set Screws Type

1.9685 in	ID	50.00 mm
4.3701 in	SB	111.0 mm

Group No. FU 0334 - 1

SLB	UCFS 210
ASAHI	UCLF 210
FYH	SLF 210
LINK BELT	F 3 - U 2 M 50 N
RHP	SF 50
SNR	SF 50

Figure MU 14
Standard Duty
Two Bolts Flanged Units - Cast Housing
Eccentric Locking Collar Type, Set Screws Type

1.9685 in	ID	50.00 mm
6.1811 in	SB	157.00 mm

Group No. FU 0329 - 1

SLB	UCFT 210
ASAHI	UCFT 210
LINK BELT	FX 3 - U 2 M 50 N
RHP	SFT 50
SNR	SFT 50

Group No. FU 0329 - 2

SLB	UELFT 210
NTN	UELFLU 210 D 1 W 3
RHP	SFT 50 DEC

Group No. FU 0329 - 3

SLB	SAFT 210
FAFNIR	VCJT - 50
RHP	SFT 50 EC
SNR	SFT 50 EC

Figure MU 18
Standard Duty
Two Bolts Flanged Units - Cast Housing
Adapter Type

1.9685 in	ID	50.00 mm
7.2441 in	SB	184.00 mm

Group No. FU 0331 - 1

SLB	UKFL 211
FYH	UKFL 211
NACHI	UKFL 211
NSK	UKFL 211
NTN	UKFL 211 D 1

Group No. FU 0334 - 2

SLB	UELFS 210
FAFNIR	RCJ - 50
NTN	UELFU 210 D 1 W 3
RHP	SF 50 DEC

Group No. FU 0334 - 3

SLB	SAFS 210
FAFNIR	VCJ - 50
RHP	SF 50 EC
SNR	SF 50 EC

Figure MU 20
Medium Duty
Two Bolts Flanged Units - Cast Housing
Set Screws Type

1.9685 in	ID	50.00 mm
7.2441 in	SB	184.00 mm

Group No. FU 0332 - 1

SLB	UCFL X10
ASAHI	UCFL X10
FYH	UCFL X10
NSK	UCFL X10
NTN	UCFL X10 D 1
RHP	MSFT 50
SEALMASTER	MSFT - 310

Figure MU 12
Standard Duty
Flanged Units - Cast Housing
Eccentric Locking Collar Type, Set Screws Type

2.0000 in	ID	50.80 mm
4.3701 in	SB	111.00 mm

Group No. FU 0335 - 1

SLB	UCF 210 - 32
NTN	UCF 210 - 200 D 1
SEALMASTER	SF - 32 R

Figure MU 15
Standard Duty
Two Bolts Flanged Units - Cast Housing
Eccentric Locking Collar Type, Set Screws Type

1.9685 in	ID	50.00 mm
6.1811 in	SB	157.00 mm

Group No. FU 0330 - 1

SLB	UCFL 210
ASAHI	UCFL 210
FYH	UCFL 210
INA	RCJTY 50
KOYO	UCFL 210
NACHI	UCFL 210
NSK	ULFL 210
NTN	UCFL 210 D 1
SEALMASTER	SFT - 20
SKF	FYT 50 TM

Figure MU 22
Heavy Duty
Two Bolts Flanged Units - Cast Housing
Set Screws Type

1.9685 in	ID	50.00 mm
7.3622 in	SB	187.00 mm

Group No. FU 0333 - 1

SLB	UCFL 310
ASAHI	UCFL 310

Group No. FU 0335 - 2

SLB	UELFL 210 - 32
NTN	UELFL 210 - 200 D 1 W 3

Figure MU 12
Standard Duty
Flanged Units - Cast Housing
Eccentric Locking Collar Type, Set Screws Type

2.0000 in	ID	50.80 mm
5.1181 in	SB	130.00 mm

Group No. FU 0336 - 1	
SLB	UCF 211 - 32
ASAHI	UCF 211 - 32
BROWNING	VF 4 S - 232
FAG	FG 56211.200
FYH	UCF 211 - 32
INA	RCJY 2"
KOYO	UCF 211 - 32
NACHI	UCF 211 - 32
NSK	UCF 211 - 32 S
NTN	UCF 211 - 200 D 1
SEALMASTER	SF - 32
SKF	FY 2 TM

Group No. FU 0336 - 2	
SLB	UELF 211 - 32
NACHI	UGF 211 - 32 + ER
NTN	UELF 211 - 200 D 1 W 3
SKF	FY 2 WM

Group No. FU 0336 - 3	
SLB	SAF 211 - 32
INA	PCJ 2"
KOYO	GARAF 200 A
SKF	FY 2 FM

Figure MU 19
Medium Duty
 Flanged Units - Cast Housing
 Set Screws Type

2.0000 in	ID	50.80 mm
5.1181 in	SB	130.00 mm

Group No. FU 0337 - 1	
SLB	UCF X10 - 32
ASAHI	UCF X10 - 32
FYH	UCF X10 - 32
INA	RCJY 2" - MP
NTN	UCF X10 - 200 D 1
RHP	MSF 2
SEALMASTER	MSF - 32
SNR	MSF 2

Figure MU 21
Heavy Duty
 Flanged Units - Cast Housing
 Set Screws Type

2.0000 in	ID	50.80 mm
5.1969 in	SB	132.00 mm

Group No. FU 0338 - 1	
SLB	UCF 310 - 32
FYH	UCF 310 - 32

Figure MU 13
Standard Duty
 Flanged Cartridge Units - Cast Housing
 Eccentric Locking Collar Type, Set Screws Type

2.0000 in	ID	50.80 mm
5.4331 in	SB	138.00 mm

Group No. FU 0339 - 1	
SLB	UCFC 210 - 32
NTN	UCFC 210 - 200 D 1
RHP	FC 2 R

Group No. FU 0339 - 2	
SLB	UELFC 210 - 32
NTN	UELFC 210 - 200 D 1 W 3

Figure MU 21
Heavy Duty
 Flanged Units - Cast Housing
 Set Screws Type

2.0000 in	ID	50.80 mm
5.5118 in	SB	140.00 mm

Group No. FU 0340 - 1	
SLB	UCF 311 - 32
ASAHI	UCF 311 - 32
FYH	UCF 311 - 32
NSK	UCF 311 - 32 S
NTN	UCF 311 - 200 D 1

Figure MU 19
Medium Duty
 Flanged Units - Cast Housing
 Set Screws Type

2.0000 in	ID	50.80 mm
5.6299 in	SB	143.00 mm

Group No. FU 0341 - 1	
SLB	UCF X11 - 32
BROWNING	VF 4 S - 332

Figure MU 13
Standard Duty
 Flanged Cartridge Units - Cast Housing
 Eccentric Locking Collar Type, Set Screws Type

2.0000 in	ID	50.80 mm
5.9055 in	SB	150.00 mm

Group No. FU 0342 - 1	
SLB	UCFC 211 - 32
ASAHI	UCFC 211 - 32
FYH	UCFC 211 - 32
INA	RMEY 2"

NACHI	UCFC 211 - 32
NSK	UCFC 211 - 32 S
NTN	UCFC 211 - 200 D 1
RHP	FC 2

Group No. FU 0342 - 2	
SLB	UELFC 211 - 32
NACHI	UGFC 211 - 32 + ER
NTN	UELFC 211 - 200 D 1 W 3
RHP	FC 2 DEC

Figure MU 14
Standard Duty
 Two Bolts Flanged Units - Cast Housing
 Eccentric Locking Collar Type, Set Screws Type

2.0000 in	ID	50.80 mm
6.1811 in	SB	157.00 mm

Group No. FU 0343 - 1	
SLB	UCFT 210 - 32
LINK BELT	FX 3 - U 2 E 32 N
RHP	SFT 2 R

Group No. FU 0343 - 2	
SLB	UELFT 210 - 32
LINK BELT	FX 3 - Y 2 E 32 N
NTN	UELFLU 210 - 200 D 1 W 3

Group No. FU 0343 - 3	
SLB	SAFT 210 - 32
FAFNIR	VCJT - 2 S
LINK BELT	FX 3 - W 2 E 32 U

Figure MU 15
Standard Duty
 Two Bolts Flanged Units - Cast Housing
 Eccentric Locking Collar Type, Set Screws Type

2.0000 in	ID	50.80 mm
6.1811 in	SB	157.00 mm

Group No. FU 0344 - 1	
SLB	UCFL 210 - 32
NTN	UCFL 210 - 200 D 1
SEALMASTER	SFT - 32 R

Group No. FU 0344 - 2	
SLB	UELFL 210 - 32
NTN	UELFL 210 - 200 D 1 W 3

Figure MU 14
Standard Duty
 Two Bolts Flanged Units - Cast Housing
 Eccentric Locking Collar Type, Set Screws Type

2.0000 in	ID	50.80 mm
7.2441 in	SB	184.00 mm

Group No. FU 0345 - 1

SLB	UCFT 211 - 32
ASAHI	UCFT 211 - 32
LINK BELT	FX 3 - U 232 N
RHP	SFT 2

Group No. FU 0345 - 2

SLB	UELFT 211 - 32
BROWNING	VF 2 E - 232
LINK BELT	FX 3 - Y 232 N
NTN	UELFLU 211 - 200 D 1 W 3
RHP	SFT 2 DEC

Group No. FU 0345 - 3

SLB	SAFT 211 - 32
FAFNIR	VCJT - 2

Figure MU 15

Standard Duty
Two Bolts Flanged Units - Cast Housing
Eccentric Locking Collar Type, Set Screws Type

2.0000 in	ID	50.80 mm
7.2441 in	SB	184.00 mm

Group No. FU 0346 - 1

SLB	UCFL 211 - 32
ASAHI	UCFL 211 - 32
BROWNING	VF 2 S - 232
FYH	UCFL 211 - 32
INA	RCJTY 2"
NACHI	UCFL 211 - 32
NSK	ULFL 211 - 32 S
NTN	UCFL 211 - 200 D 1
SEALMASTER	SFT - 32 R
SKF	FYT 2 TM

Group No. FU 0346 - 2

SLB	UELFL 211 - 32
FAFNIR	RCJT - 2
NACHI	UGFL 211 - 32 + ER
NTN	UELFL 211 - 200 D 1 W 3
SKF	FYT 2 WM

Group No. FU 0346 - 3

SLB	SAFL 211 - 32
INA	PCJT 2"
SKF	FYT 2 FM

Figure MU 20

Medium Duty
Two Bolts Flanged Units - Cast Housing
Set Screws Type

2.0000 in	ID	50.80 mm
7.2441 in	SB	184.00 mm

Group No. FU 0347 - 1

SLB	UCFL X10 - 32
ASAHI	UCFL X10 - 32
FYH	UCFL X10 - 32
NTN	UCFL X10 - 200 D 1
RHP	MSFT 2
SEALMASTER	MSFT - 32

Figure MU 22

Heavy Duty
Two Bolts Flanged Units - Cast Housing
Set Screws Type

2.0000 in	ID	50.80 mm
7.3622 in	SB	187.00 mm

Group No. FU 0348 - 1

SLB	UCFL 310 - 32
FYH	UCFL 310 - 32

Figure MU 22

Heavy Duty
Two Bolts Flanged Units - Cast Housing
Set Screws Type

2.0000 in	ID	50.80 mm
7.7953 in	SB	198.00 mm

Group No. FU 0349 - 1

SLB	UCFL 311 - 32
ASAHI	UCFL 311 - 32
FYH	UCFL 311 - 32
NSK	UCFL 311 - 32 S
NTN	UCFL 311 - 200 D 1

Figure MU 11

Standard Duty
Flanged Units - Cast Housing
Eccentric Locking Collar Type, Set Screws Type

2.0000 in	ID	50.80 mm
4.3701 in	SB	111.0 mm

Group No. FU 0350 - 1

SLB	UCFS 210 - 32
LINK BELT	F 3 - U 2 E 32 N
RHP	SF 2 R

Group No. FU 0350 - 2

SLB	UELFS 210 - 32
LINK BELT	F 3 - Y 2 E 32 N
NTN	UELFU 210 - 200 D 1 W 3

Group No. FU 0350 - 3

SLB	SAFS 210 - 32
FAFNIR	VCJ - 2 S
LINK BELT	F 3 - W 2 E 32 U

Figure MU 11

Standard Duty
Flanged Units - Cast Housing
Eccentric Locking Collar Type, Set Screws Type

2.0000 in	ID	50.80 mm
5.1181 in	SB	130.0 mm

Group No. FU 0351 - 1

SLB	UCFS 211 - 32
ASAHI	UCLF 211 - 32
FYH	SLF 211 - 32
LINK BELT	F 3 - U 232 N
RHP	SF 2

Group No. FU 0351 - 2

SLB	UELFS 211 - 32
BROWNING	VF 4 E - 232
FAFNIR	RCJ - 2
LINK BELT	F 3 - Y 232 N
NTN	UELFU 211 - 200 D 1 W 3
RHP	SF 2 DEC

Group No. FU 0351 - 3

SLB	SAFS 211 - 32
FAFNIR	VCJ - 2

Figure MU 12

Standard Duty
Flanged Units - Cast Housing
Eccentric Locking Collar Type, Set Screws Type

2.0625 in	ID	52.39 mm
5.1181 in	SB	130.00 mm

Group No. FU 0352 - 1

SLB	UCF 211 - 33
ASAHI	UCF 211 - 33
NACHI	UCF 211 - 33
NTN	UCF 211 - 201 D 1

Group No. FU 0352 - 2

SLB	UELFL 211 - 33
NTN	UELFL 211 - 201 D 1 W 3

Figure MU 21

Heavy Duty
Flanged Units - Cast Housing
Set Screws Type

2.0625 in	ID	52.39 mm
5.5118 in	SB	140.00 mm

Group No. FU 0353 - 1

SLB	UCF 311 - 33
NTN	UCF 311 - 201 D 1

Figure MU 19 
 Medium Duty
 Flanged Units - Cast Housing
 Set Screws Type

2.0625 in	ID	52.39 mm
5.6299 in	SB	143.00 mm

Group No. FU 0354 - 1

SLB	UCF X11 - 33
NTN	UCF X11 - 201 D 1

Figure MU 13 
 Standard Duty
 Flanged Cartridge Units - Cast Housing
 Eccentric Locking Collar Type, Set Screws Type

2.0625 in	ID	52.39 mm
5.9055 in	SB	150.00 mm

Group No. FU 0355 - 1

SLB	UCFC 211 - 33
ASAHI	UCFC 211 - 33
NACHI	UCFC 211 - 33
NTN	UCFC 211 - 201 D 1

Group No. FU 0355 - 2

SLB	UELFC 211 - 33
NTN	UELFC 211 - 201 D 1 W 3

Figure MU 14 
 Standard Duty
 Two Bolts Flanged Units - Cast Housing
 Eccentric Locking Collar Type, Set Screws Type

2.0625 in	ID	52.39 mm
7.2441 in	SB	184.00 mm

Group No. FU 0356 - 1

SLB	UCFT 211 - 33
ASAHI	UCFT 211 - 33

Group No. FU 0356 - 2

SLB	UELFT 211 - 33
NTN	UELFLU 211 - 201 D 1 W 3

Group No. FU 0356 - 3

SLB	SAFT 211 - 33
FAFNIR	VCJT - 2 - 1/16

Figure MU 15 
 Standard Duty
 Two Bolts Flanged Units - Cast Housing
 Eccentric Locking Collar Type, Set Screws Type

2.0625 in	ID	52.39 mm
7.2441 in	SB	184.00 mm

Group No. FU 0357 - 1

SLB	UCFL 211 - 33
ASAHI	UCFL 211 - 33
NACHI	UCFL 211 - 33
NTN	UCFL 211 - 201 D 1

Group No. FU 0357 - 2

SLB	UELFL 211 - 33
FAFNIR	RCJT - 2 - 1/16
NTN	UELFL 211 - 201 D 1 W 3

Figure MU 22 
 Heavy Duty
 Two Bolts Flanged Units - Cast Housing
 Set Screws Type

2.0625 in	ID	52.39 mm
7.7953 in	SB	198.00 mm

Group No. FU 0358 - 1

SLB	UCFL 311 - 33
NTN	UCFL 311 - 201 D 1

Figure MU 11 
 Standard Duty
 Flanged Units - Cast Housing
 Eccentric Locking Collar Type, Set Screws Type

2.0625 in	ID	52.39 mm
5.1181 in	SB	130.0 mm

Group No. FU 0359 - 1

SLB	UCFS 211 - 33
ASAHI	UCLF 211 - 33

Group No. FU 0359 - 2

SLB	UELFS 211 - 33
FAFNIR	RCJ - 2 - 1/16
NTN	UELFU 211 - 201 D 1 W 3

Group No. FU 0359 - 3

SLB	SAFS 211 - 33
FAFNIR	VCJ - 2 - 1/16

Figure MU 12 
 Standard Duty
 Flanged Units - Cast Housing
 Eccentric Locking Collar Type, Set Screws Type

2.1250 in	ID	53.98 mm
5.1181 in	SB	130.00 mm

Group No. FU 0360 - 1

SLB	UCF 211 - 34
ASAHI	UCF 211 - 34
FYH	UCF 211 - 34
NACHI	UCF 211 - 34

NSK	UCF 211 - 34 S
NTN	UCF 211 - 202 D 1
SEALMASTER	SF - 34

Group No. FU 0360 - 2

SLB	UELF 211 - 34
NACHI	UGF 211 - 34 + ER
NTN	UELF 211 - 202 D 1 W 3

Figure MU 21 
 Heavy Duty
 Flanged Units - Cast Housing
 Set Screws Type

2.1250 in	ID	53.98 mm
5.5118 in	SB	140.00 mm

Group No. FU 0361 - 1

SLB	UCF 311 - 34
ASAHI	UCF 311 - 34
NSK	UCF 311 - 34 S
NTN	UCF 311 - 202 D 1

Figure MU 19 
 Medium Duty
 Flanged Units - Cast Housing
 Set Screws Type

2.1250 in	ID	53.98 mm
5.6299 in	SB	143.00 mm

Group No. FU 0362 - 1

SLB	UCF X11 - 34
ASAHI	UCF X11 - 34
NTN	UCF X11 - 202 D 1

Figure MU 13 
 Standard Duty
 Flanged Cartridge Units - Cast Housing
 Eccentric Locking Collar Type, Set Screws Type

2.1250 in	ID	53.98 mm
5.9055 in	SB	150.00 mm

Group No. FU 0363 - 1

SLB	UCFC 211 - 34
ASAHI	UCFC 211 - 34
FYH	UCFC 211 - 34
NACHI	UCFC 211 - 34
NSK	UCFC 211 - 34 S
NTN	UCFC 211 - 202 D 1
RHP	FC 2 1/8

Group No. FU 0363 - 2

SLB	UELFC 211 - 34
NACHI	UGFC 211 - 34 + ER
NTN	UELFC 211 - 202 D 1 W 3
RHP	FC 2 1/8 DEC

Figure MU 14 
Standard Duty
 Two Bolts Flanged Units - Cast Housing
 Eccentric Locking Collar Type, Set Screws Type

2.1250 in	ID	53.98 mm
7.2441 in	SB	184.00 mm

Group No. FU 0364 - 1

SLB	UCFT 211 - 34
ASAHI	UCFT 211 - 34
RHP	SFT 2 1/8

Group No. FU 0364 - 2

SLB	UELFT 211 - 34
NTN	UELFLU 211 - 202 D 1 W 3
RHP	SFT 2 1/8 DEC

Group No. FU 0364 - 3

SLB	SAFT 211 - 34
FAFNIR	VCJT - 2 - 1/8

Figure MU 15 
Standard Duty
 Two Bolts Flanged Units - Cast Housing
 Eccentric Locking Collar Type, Set Screws Type

2.1250 in	ID	53.98 mm
7.2441 in	SB	184.00 mm

Group No. FU 0365 - 1

SLB	UCFL 211 - 34
ASAHI	UCFL 211 - 34
FYH	UCFL 211 - 34
NACHI	UCFL 211 - 34
NSK	ULFL 211 - 34 S
NTN	UCFL 211 - 202 D 1
SEALMASTER	SFT - 34

Group No. FU 0365 - 2

SLB	UELFL 211 - 34
FAFNIR	RCJT - 2 - 1/8
NACHI	UGFL 211 - 34 + ER
NTN	UELFL 211 - 202 D 1 W 3

Figure MU 22 
Heavy Duty
 Two Bolts Flanged Units - Cast Housing
 Set Screws Type

2.1250 in	ID	53.98 mm
7.7953 in	SB	198.00 mm

Group No. FU 0366 - 1

SLB	UCFL 311 - 34
ASAHI	UCFL 311 - 34
NSK	UCFL 311 - 34 S
NTN	UCFL 311 - 202 D 1

Figure MU 11 
Standard Duty
 Flanged Units - Cast Housing
 Eccentric Locking Collar Type, Set Screws Type

2.1250 in	ID	53.98 mm
5.1181 in	SB	130.0 mm

Group No. FU 0367 - 1

SLB	UCFS 211 - 34
ASAHI	UCLF 211 - 34
FYH	SLF 211 - 34
RHP	SF 2 1/8

Group No. FU 0367 - 2

SLB	UELFS 211 - 34
FAFNIR	RCJ - 2 - 1/8
NTN	UELFU 211 - 202 D 1 W 3
RHP	SF 2 1/8 DEC

Group No. FU 0367 - 3

SLB	SAFS 211 - 34
FAFNIR	VCJ - 2 - 1/8

Figure MU 12 
Standard Duty
 Flanged Units - Cast Housing
 Eccentric Locking Collar Type, Set Screws Type

2.1654 in	ID	55.00 mm
5.1181 in	SB	130.00 mm

Group No. FU 0368 - 1

SLB	UCF 211
ASAHI	UCF 211
FAG	FG 56211
FYH	UCF 211
INA	RCJY 55
KOYO	UCF 211
NACHI	UCF 211
NSK	UCF 211
NTN	UCF 211 D 1
SEALMASTER	SF - 211
SKF	FY 55 TM

Group No. FU 0368 - 2

SLB	UELF 211
INA	RCJ 55
NACHI	UGF 211 + ER
NSK	EFW 211
NTN	UELF 211 D 1 W 3
SKF	FY 55 WM

Group No. FU 0368 - 3

SLB	SAF 211
INA	PCJ 55
KOYO	GARAF 203 MA
SKF	FY 55 FM

Figure MU 21 
Heavy Duty
 Flanged Units - Cast Housing
 Set Screws Type

2.1654 in	ID	55.00 mm
5.5118 in	SB	140.00 mm

Group No. FU 0369 - 1

SLB	UCF 311
ASAHI	UCF 311
FYH	UCF 311
NSK	UCF 311
NTN	UCF 311 D 1

Figure MU 16 
Standard Duty
 Flanged Units - Cast Housing
 Adapter Type

2.1654 in	ID	55.00 mm
5.6299 in	SB	143.00 mm

Group No. FU 0370 - 1

SLB	UKF 212
ASAHI	UKF 212
FYH	UKF 212
NACHI	UKF 212
NSK	UKF 212
NTN	UKF 212 D 1

Figure MU 19 
Medium Duty
 Flanged Units - Cast Housing
 Set Screws Type

2.1654 in	ID	55.00 mm
5.6299 in	SB	143.00 mm

Group No. FU 0371 - 1

SLB	UCF X11
ASAHI	UCF X11
FYH	UCF X11
NSK	UCF X11
NTN	UCF X11 D 1
RHP	MSF 55
SEALMASTER	MSF - 311
SNR	MSF 55

Figure MU 13 
Standard Duty
 Flanged Cartridge Units - Cast Housing
 Eccentric Locking Collar Type, Set Screws Type

2.1654 in	ID	55.00 mm
5.9055 in	SB	150.00 mm

Group No. FU 0372 - 1	
SLB	UCFC 211
ASAHI	UCFC 211
FYH	UCFC 211
INA	RMEY 55
NACHI	UCFC 211
NSK	UCFC 211
NTN	UCFC 211 D 1
RHP	FC 55

Group No. FU 0372 - 2	
SLB	UELFC 211
INA	RME 55
NACHI	UGFC 211 + ER
NSK	EWFC 211
NTN	UELFC 211 D 1 W 3
RHP	FC 55 DEC

Group No. FU 0372 - 3	
SLB	SAFC 211
INA	PME 55

Figure MU 17	
<i>Standard Duty</i>	
<i>Flanged Cartridge Units - Cast Housing Adapter Type</i>	
2.1654 in	ID 55.00 mm
6.2992 in	SB 160.00 mm

Group No. FU 0373 - 1	
SLB	UKFC 212
FYH	UKFC 212
NACHI	UKFC 212
NSK	UKFC 212
NTN	UKFC 212 D 1

Figure MU 14	
<i>Standard Duty</i>	
<i>Two Bolts Flanged Units - Cast Housing Eccentric Locking Collar Type, Set Screws Type</i>	
2.1654 in	ID 55.00 mm
7.2441 in	SB 184.00 mm

Group No. FU 0374 - 1	
SLB	UCFT 211
ASAHI	UCFT 211
LINK BELT	FX 3 - U 2 M 55 N
RHP	SFT 55

Group No. FU 0374 - 2	
SLB	UELFT 211
NTN	UELFLU 211 D 1 W 3
RHP	SFT 55 DEC

Group No. FU 0374 - 3	
SLB	SAFT 211
FAFNIR	VCJT - 55

Figure MU 15	
<i>Standard Duty</i>	
<i>Two Bolts Flanged Units - Cast Housing Eccentric Locking Collar Type, Set Screws Type</i>	
2.1654 in	ID 55.00 mm
7.2441 in	SB 184.00 mm

Group No. FU 0375 - 1	
SLB	UCFL 211
ASAHI	UCFL 211
FYH	UCFL 211
INA	RCJTY 55
NACHI	UCFL 211
NSK	ULFL 211
NTN	UCFL 211 D 1
SEALMASTER	SFT - 211
SKF	FYT 55 TM

Group No. FU 0375 - 2	
SLB	UELFL 211
FAFNIR	RCJT - 55
INA	RCJT 55
NACHI	UGFL 211 + ER
NSK	EWFL 211
NTN	UELFL 211 D 1 W 3
SKF	FYT 55 WM

Group No. FU 0375 - 3	
SLB	SAFL 211
INA	PCJT 55
SKF	FYT 55 FM

Figure MU 22	
<i>Heavy Duty</i>	
<i>Two Bolts Flanged Units - Cast Housing Set Screws Type</i>	
2.1654 in	ID 55.00 mm
7.7953 in	SB 198.00 mm

Group No. FU 0376 - 1	
SLB	UCFL 311
ASAHI	UCFL 311
FYH	UCFL 311
NSK	UCFL 311
NTN	UCFL 311 D 1

Figure MU 18	
<i>Standard Duty</i>	
<i>Two Bolts Flanged Units - Cast Housing Adapter Type</i>	
2.1654 in	ID 55.00 mm
7.9528 in	SB 202.00 mm

Group No. FU 0377 - 1	
SLB	UKFL 212
FYH	UKFL 212

NACHI	UKFL 212
NSK	UKFL 212
NTN	UKFL 212 D 1

Figure MU 11	
<i>Standard Duty</i>	
<i>Flanged Units - Cast Housing Eccentric Locking Collar Type, Set Screws Type</i>	
2.1654 in	ID 55.00 mm
5.1181 in	SB 130.00 mm

Group No. FU 0378 - 1	
SLB	UCFS 211
ASAHI	UCLF 211
FYH	SLF 211
LINK BELT	FE - U 2 M 55 N
RHP	SF 55
SNR	SF 55

Group No. FU 0378 - 2	
SLB	UELFS 211
FAFNIR	RCJ - 55
NTN	UELFU 211 D 1 W 3
RHP	SF 55 DEC

Group No. FU 0378 - 3	
SLB	SAFS 211
FAFNIR	VCJ - 55

Figure MU 12	
<i>Standard Duty</i>	
<i>Flanged Units - Cast Housing Eccentric Locking Collar Type, Set Screws Type</i>	
2.1875 in	ID 55.56 mm
5.1181 in	SB 130.00 mm

Group No. FU 0379 - 1	
SLB	UCF 211 - 35
ASAHI	UCF 211 - 35
BROWNING	VF 4 S - 235
FAG	FG 56211.203
FYH	UCF 211 - 35
KOYO	UCF 211 - 35
NACHI	UCF 211 - 35
NTN	UCF 211 - 203 D 1
SEALMASTER	SF - 35
SKF	FY 2 - 3/16 TM

Group No. FU 0379 - 2	
SLB	UELFL 211 - 35
INA	RCJ 2 3/16"
NACHI	UGF 211 - 35 + ER
NTN	UELFL 211 - 203 D 1 W 3
SKF	FY 2 - 3/16 WM

Group No. FU 0379 - 3	
SLB	SAF 211 - 35
INA	PCJ 2 3/16"
KOYO	GARAF 203 A
SKF	FY 2 - 3/16 FM

Figure MU 21	
<i>Heavy Duty</i>	
<i>Flanged Units - Cast Housing</i>	
<i>Set Screws Type</i>	
2.1875 in	ID 55.56 mm
5.5118 in	SB 140.00 mm

Group No. FU 0380 - 1	
SLB	UCF 311 - 35
NTN	UCF 311 - 203 D 1

Figure MU 19	
<i>Medium Duty</i>	
<i>Flanged Units - Cast Housing</i>	
<i>Set Screws Type</i>	
2.1875 in	ID 55.56 mm
5.6299 in	SB 143.00 mm

Group No. FU 0381 - 1	
SLB	UCF X11 - 35
ASAHI	UCF X11 - 35
BROWNING	VF 4 S - 335
FYH	UCF X11 - 35
NTN	UCF X11 - 203 D 1
RHP	MSF 2 3/16
SEALMASTER	MSF - 35
SKF	FYM 2 - 3/16 TM
SNR	MSF 2 3/16

Figure MU 13	
<i>Standard Duty</i>	
<i>Flanged Cartridge Units - Cast Housing</i>	
<i>Eccentric Locking Collar Type, Set Screws Type</i>	
2.1875 in	ID 55.56 mm
5.9055 in	SB 150.00 mm

Group No. FU 0382 - 1	
SLB	UCFC 211 - 35
ASAHI	UCFC 211 - 35
FYH	UCFC 211 - 35
NACHI	UCFC 211 - 35
NTN	UCFC 211 - 203 D 1
RHP	FC 2 3/16

Group No. FU 0382 - 2	
SLB	UELFC 211 - 35
NACHI	UGFC 211 - 35 + ER
NTN	UELFC 211 - 203 D 1 W 3
RHP	FC 2 3/16 DEC

Figure MU 14	
<i>Standard Duty</i>	
<i>Two Bolts Flanged Units - Cast Housing</i>	
<i>Eccentric Locking Collar Type, Set Screws Type</i>	
2.1875 in	ID 55.56 mm
7.2441 in	SB 184.00 mm

Group No. FU 0383 - 1	
SLB	UCFT 211 - 35
ASAHI	UCFT 211 - 35
LINK BELT	FX 3 - U 235 N
RHP	SFT 2 3/16

Group No. FU 0383 - 2	
SLB	UELFT 211 - 35
BROWNING	VF 2 E - 235
LINK BELT	FX 3 - Y 235 N
NTN	UELFLU 211 - 203 D 1 W 3
RHP	SFT 2 3/16 DEC

Group No. FU 0383 - 3	
SLB	SAFT 211 - 35
FAFNIR	VCJT - 2 - 3/16

Figure MU 15	
<i>Standard Duty</i>	
<i>Two Bolts Flanged Units - Cast Housing</i>	
<i>Eccentric Locking Collar Type, Set Screws Type</i>	
2.1875 in	ID 55.56 mm
7.2441 in	SB 184.00 mm

Group No. FU 0384 - 1	
SLB	UCFL 211 - 35
ASAHI	UCFL 211 - 35
BROWNING	VF 2 S - 235
FYH	UCFL 211 - 35
NACHI	UCFL 211 - 35
NTN	UCFL 211 - 203 D 1
SEALMASTER	SFT - 35
SKF	FYT 2 - 3/16 TM

Group No. FU 0384 - 2	
SLB	UELFL 211 - 35
FAFNIR	RCJT - 2 - 3/16
NACHI	UGFL 211 - 35 + ER
NTN	UELFL 211 - 203 D 1 W 3
SKF	FYT 2 - 3/16 WM

Group No. FU 0384 - 3	
SLB	SAFL 211 - 35
SKF	FYT 2 - 3/16 FM

Figure MU 22	
<i>Heavy Duty</i>	
<i>Two Bolts Flanged Units - Cast Housing</i>	
<i>Set Screws Type</i>	

2.1875 in	ID	55.56 mm
7.7953 in	SB	198.00 mm

Group No. FU 0385 - 1	
SLB	UCFL 311 - 35
NTN	UCFL 311 - 203 D 1

Figure MU 11	
<i>Standard Duty</i>	
<i>Flanged Units - Cast Housing</i>	
<i>Eccentric Locking Collar Type, Set Screws Type</i>	
2.1875 in	ID 55.56 mm
5.1181 in	SB 130.0 mm

Group No. FU 0386 - 1	
SLB	UCFS 211 - 35
ASAHI	UCLF 211 - 35
FYH	SLF 211 - 35
LINK BELT	F 3 - 235 N
RHP	SF 2 3/16

Group No. FU 0386 - 2	
SLB	UELFS 211 - 35
BROWNING	VF 4 E - 235
FAFNIR	RCJ - 2 - 3/16
LINK BELT	F 3 - Y 235 N
NTN	UELFU 211 - 203 D 1 W 3
RHP	SF 2 3/16 DEC

Group No. FU 0386 - 3	
SLB	SAFS 211 - 35
FAFNIR	VCJ - 2 - 3/16

Figure MU 12	
<i>Standard Duty</i>	
<i>Flanged Units - Cast Housing</i>	
<i>Eccentric Locking Collar Type, Set Screws Type</i>	
2.2500 in	ID 57.15 mm
5.6299 in	SB 143.00 mm

Group No. FU 0387 - 1	
SLB	UCF 212 - 36
ASAHI	UCF 212 - 36
BROWNING	VF 4 S - 236
FAG	FG 56212.204
FYH	UCF 212 - 36
KOYO	UCF 212 - 36
NACHI	UCF 212 - 36
NSK	UCF 212 - 36 S
NTN	UCF 212 - 204 D 1
SEALMASTER	SF - 36
SKF	FY 2 - 1/4 TM

Group No. FU 0387 - 2	
SLB	UELFC 212 - 36
NACHI	UGF 212 - 36 + ER
NTN	UELFC 212 - 204 D 1 W 3
SKF	FY 2 - 1/4 WM

Figure MU 19 
 Medium Duty
 Flanged Units - Cast Housing
 Set Screws Type

2.2500 in	ID	57.15 mm
5.8661 in	SB	149.00 mm

Group No. FU 0388 - 1

SLB	UCF X12 - 36
ASAHI	UCF X12 - 36
FYH	UCF X12 - 36
RHP	MSF 2 1/4
SEALMASTER	MSF - 36
SNR	MSF 2 1/4

Figure MU 21 
 Heavy Duty
 Flanged Units - Cast Housing
 Set Screws Type

2.2500 in	ID	57.15 mm
5.9055 in	SB	150.00 mm

Group No. FU 0389 - 1

SLB	UCF 312 - 36
ASAHI	UCF 312 - 36
NSK	UCF 312 - 36 S
NTN	UCF 312 - 204 D 1

Figure MU 13 
 Standard Duty
 Flanged Cartridge Units - Cast Housing
 Eccentric Locking Collar Type, Set Screws Type

2.2500 in	ID	57.15 mm
6.2992 in	SB	160.00 mm

Group No. FU 0390 - 1

SLB	UCFC 212 - 36
ASAHI	UCFC 212 - 36
FYH	UCFC 212 - 36
NACHI	UCFC 212 - 36
NSK	UCFC 212 - 36 S
NTN	UCFC 212 - 204 D 1
RHP	FC 2 1/4

Group No. FU 0390 - 2

SLB	UELFC 212 - 36
NACHI	UGFC 212 - 36 + ER
NTN	UELFC 212 - 204 D 1 W 3
RHP	FC 2 1/4 DEC

Figure MU 14 
 Standard Duty
 Two Bolts Flanged Units - Cast Housing
 Eccentric Locking Collar Type, Set Screws Type

2.2500 in	ID	57.15 mm
7.9528 in	SB	202.00 mm

Group No. FU 0391 - 1

SLB	UCFT 212 - 36
RHP	SFT 2 1/4

Group No. FU 0391 - 2

SLB	UELFT 212 - 36
BROWNING	VF 2 E - 236
NTN	UELFLU 212 - 204 D 1 W 3
RHP	SFT 2 1/4 DEC

Figure MU 15 
 Standard Duty
 Two Bolts Flanged Units - Cast Housing
 Eccentric Locking Collar Type, Set Screws Type

2.2500 in	ID	57.15 mm
7.9528 in	SB	202.00 mm

Group No. FU 0392 - 1

SLB	UCFL 212 - 36
ASAHI	UCFL 212 - 36
BROWNING	VF 2 S - 236
FYH	UCFL 212 - 36
NACHI	UCFL 212 - 36
NSK	ULFL 212 - 36 S
NTN	UCFL 212 - 204 D 1

Group No. FU 0392 - 2

SLB	UELFL 212 - 36
NACHI	UGFL 212 - 36 + ER
NTN	UELFL 212 - 204 D 1 W 3

Figure MU 22 
 Heavy Duty
 Two Bolts Flanged Units - Cast Housing
 Set Screws Type

2.2500 in	ID	57.15 mm
8.3465 in	SB	212.00 mm

Group No. FU 0393 - 1

SLB	UCFL 312 - 36
ASAHI	UCFL 312 - 36
NSK	UCFL 312 - 36 S
NTN	UCFL 312 - 204 D 1

Figure MU 11 
 Standard Duty
 Flanged Units - Cast Housing
 Eccentric Locking Collar Type, Set Screws Type

2.2500 in	ID	57.15 mm
5.6299 in	SB	143.0 mm

Group No. FU 0394 - 1

SLB	UCFS 212 - 36
ASAHI	UCLF 212 - 36
FYH	SLF 212 - 36
LINK BELT	F 3 - U 236 N
RHP	SF 2 1/4

Group No. FU 0394 - 2

SLB	UELFS 212 - 36
BROWNING	VF 4 E - 236
FAFNIR	RCJ - 2 - 1/4
LINK BELT	F 3 - Y 236 N
NTN	UELFU 212 - 204 D 1 W 3
RHP	SF 2 1/4 DEC

Figure MU 12 
 Standard Duty
 Flanged Units - Cast Housing
 Eccentric Locking Collar Type, Set Screws Type

2.3125 in	ID	58.74 mm
5.6299 in	SB	143.00 mm

Group No. FU 0395 - 1

SLB	UCF 212 - 37
NTN	UCF 212 - 205 D 1

Group No. FU 0395 - 2

SLB	UEL 212 - 37
NTN	UEL 212 - 205 D 1 W 3

Figure MU 19 
 Medium Duty
 Flanged Units - Cast Housing
 Set Screws Type

2.3125 in	ID	58.74 mm
5.8661 in	SB	149.00 mm

Group No. FU 0396 - 1

SLB	UCF X12 - 37
FYH	UCF X12 - 37

Figure MU 21 
 Heavy Duty
 Flanged Units - Cast Housing
 Set Screws Type

2.3125 in	ID	58.74 mm
5.9055 in	SB	150.00 mm

Group No. FU 0397 - 1

SLB	UCF 312 - 37
NTN	UCF 312 - 205 D 1

Figure MU 13 
Standard Duty
Flanged Cartridge Units - Cast Housing
Eccentric Locking Collar Type, Set Screws Type

2.3125 in	ID	58.74 mm
6.2992 in	SB	160.00 mm

Group No. FU 0398 - 1

SLB	UCFC 212 - 37
NTN	UCFC 212 - 205 D 1

Group No. FU 0398 - 2

SLB	UELFC 212 - 37
NTN	UELFC 212 - 205 D 1 W 3

Figure MU 11 
Standard Duty
Flanged Units - Cast Housing
Eccentric Locking Collar Type, Set Screws Type

2.3125 in	ID	58.74 mm
5.6299 in	SB	143.0 mm

Group No. FU 0402 - 1

SLB	UCFS 212 - 37
FYH	UCFS 212 - 37

Group No. FU 0402 - 2

SLB	UELFS 212 - 37
FAFNIR	RCJ - 2 - 5/16
NTN	UELFU 212 - 205 D 1 W 3

NACHI	UKF 213
NSK	UKF 213
NTN	UKF 213 D 1

Figure MU 19 
Medium Duty
Flanged Units - Cast Housing
Set Screws Type

2.3622 in	ID	60.00 mm
5.8661 in	SB	149.00 mm

Group No. FU 0405 - 1

SLB	UCF X12
ASAHI	UCF X12
FYH	UCF X12
INA	RCJY 60 - MP
NSK	UCF X12
NTN	UCF X12 D 1
RHP	MSF 60
SNR	MSF 60

Figure MU 14 
Standard Duty
Two Bolts Flanged Units - Cast Housing
Eccentric Locking Collar Type, Set Screws Type

2.3125 in	ID	58.74 mm
7.9528 in	SB	202.00 mm

Group No. FU 0399 - 1

SLB	UCFT 212 - 37
FYH	UCFT 212 - 37

Group No. FU 0399 - 2

SLB	UELFT 212 - 37
NTN	UELFU 212 - 205 D 1 W 3

Figure MU 12 
Standard Duty
Flanged Units - Cast Housing
Eccentric Locking Collar Type, Set Screws Type

2.3622 in	ID	60.00 mm
5.6299 in	SB	143.00 mm

Group No. FU 0403 - 1

SLB	UCF 212
ASAHI	UCF 212
FAG	FG 56212
FYH	UCF 212
INA	RCJY 60
KOYO	UCF 212
NACHI	UCF 212
NSK	UCF 212
NTN	UCF 212 D 1
SEALMASTER	SF - 212
SKF	FY 60 TM

Group No. FU 0403 - 2

SLB	UELF 212
INA	RCJ 60
NACHI	UGF 212 + ER
NSK	EFW 212
NTN	UELF 212 D 1 W 3
SKF	FY 60 WM

Figure MU 21 
Heavy Duty
Flanged Units - Cast Housing
Set Screws Type

2.3622 in	ID	60.00 mm
5.9055 in	SB	150.00 mm

Group No. FU 0406 - 1

SLB	UCF 312
ASAHI	UCF 312
FYH	UCF 312
INA	RCJOY 60
NSK	UCF 312
NTN	UCF 312 D 1

Figure MU 15 
Standard Duty
Two Bolts Flanged Units - Cast Housing
Eccentric Locking Collar Type, Set Screws Type

2.3125 in	ID	58.74 mm
7.9528 in	SB	202.00 mm

Group No. FU 0400 - 1

SLB	UCFL 212 - 37
NTN	UCFL 212 - 205 D 1

Group No. FU 0400 - 2

SLB	UELFL 212 - 37
NTN	UELFL 212 - 205 D 1 W 3

Figure MU 16 
Standard Duty
Flanged Units - Cast Housing
Adapter Type

2.3622 in	ID	60.00 mm
5.8661 in	SB	149.00 mm

Group No. FU 0404 - 1

SLB	UKF 213
ASAHI	UKF 213
FYH	UKF 213

Figure MU 13 
Standard Duty
Flanged Cartridge Units - Cast Housing
Eccentric Locking Collar Type, Set Screws Type

2.3622 in	ID	60.00 mm
6.2992 in	SB	160.00 mm

Group No. FU 0407 - 1

SLB	UCFC 212
ASAHI	UCFC 212
FYH	UCFC 212
INA	RMEY 60
NACHI	UCFC 212
NSK	UCFC 212
NTN	UCFC 212 D 1
RHP	FC 60

Group No. FU 0407 - 2

SLB	UELFC 212
INA	RME 60

NACHI	UGFC 212 + ER
NSK	EWFC 212
NTN	UELFC 212 D 1 W 3
RHP	FC 60 DEC

NACHI	UGFL 212 + ER
NSK	EWFL 212
NTN	UELFL 212 D 1 W 3

Figure MU 17 

Standard Duty
Flanged Cartridge Units - Cast Housing
Adapter Type

2.3622 in	ID	60.00 mm
6.6929 in	SB	170.00 mm

Group No. FU 0408 - 1

SLB	UKFC 213
FYH	UKF 213
NACHI	UKFC 213
NSK	UKFC 213
NTN	UKFC 213 D 1

Figure MU 18 

Standard Duty
Two Bolts Flanged Units - Cast Housing
Adapter Type

2.3622 in	ID	60.00 mm
8.2677 in	SB	210.00 mm

Group No. FU 0411 - 1

SLB	UKFL 213
FYH	UKFL 213
NACHI	UKFL 213
NSK	UKFL 213
NTN	UKFL 213 D 1

Figure MU 12 

Standard Duty
Flanged Units - Cast Housing
Eccentric Locking Collar Type, Set Screws Type

2.3750 in	ID	60.33 mm
5.6299 in	SB	143.00 mm

Group No. FU 0414 - 1

SLB	UCF 212 - 38
ASAHI	UCF 212 - 38
FYH	UCF 212 - 38
NACHI	UCF 212 - 38
NSK	UCF 212 - 38 S
NTN	UCF 212 - 206 D 1
SEALMASTER	SF - 38

Group No. FU 0414 - 2

SLB	UELFL 212 - 38
NACHI	UGF 212 - 38 + ER
NTN	UELFL 212 - 206 D 1 W 3

Figure MU 14 

Standard Duty
Two Bolts Flanged Units - Cast Housing
Eccentric Locking Collar Type, Set Screws Type

2.3622 in	ID	60.00 mm
7.9528 in	SB	202.00 mm

Group No. FU 0409 - 1

SLB	UCFT 212
RHP	SFT 60

Group No. FU 0409 - 2

SLB	UELFT 212
NTN	UELFLU 212 D 1 W 3
RHP	SFT 60 DEC

Figure MU 22 

Heavy Duty
Two Bolts Flanged Units - Cast Housing
Set Screws Type

2.3622 in	ID	60.00 mm
8.3465 in	SB	212.00 mm

Group No. FU 0412 - 1

SLB	UCFL 312
ASAHI	UCFL 312
FYH	UCFL 312
NSK	UCFL 312
NTN	UCFL 312 D 1

Figure MU 19 

Medium Duty
Flanged Units - Cast Housing
Set Screws Type

2.3750 in	ID	60.33 mm
5.8661 in	SB	149.00 mm

Group No. FU 0415 - 1

SLB	UCF X12 - 38
ASAHI	UCF X12 - 38
FYH	UCF X12 - 38
NTN	UCF X12 - 206 D 1

Figure MU 15 

Standard Duty
Two Bolts Flanged Units - Cast Housing
Eccentric Locking Collar Type, Set Screws Type

2.3622 in	ID	60.00 mm
7.9528 in	SB	202.00 mm

Group No. FU 0410 - 1

SLB	UCFL 212
ASAHI	UCFL 212
FYH	UCFL 212
INA	RCJTY 60
NACHI	UCFL 212
NSK	ULFL 212
NTN	UCFL 212 D 1

Group No. FU 0410 - 2

SLB	UELFL 212
INA	RCJT 60

Figure MU 11 

Standard Duty
Flanged Units - Cast Housing
Eccentric Locking Collar Type, Set Screws Type

2.3622 in	ID	60.00 mm
5.6299 in	SB	143.0 mm

Group No. FU 0413 - 1

SLB	UCFS 212
ASAHI	UCLF 212
FYH	SLF 212
LINK BELT	F 3 - U 2 M 60 N
RHP	SF 60
SNR	SF 60

Group No. FU 0413 - 2

SLB	UELFS 212
FAFNIR	RCJ - 60
NTN	UELFLU 212 D 1 W 3
RHP	SF 60 DEC

Figure MU 21 

Heavy Duty
Flanged Units - Cast Housing
Set Screws Type

2.3750 in	ID	60.33 mm
5.9055 in	SB	150.00 mm

Group No. FU 0416 - 1

SLB	UCF 312 - 38
ASAHI	UCF 312 - 38
NSK	UCF 312 - 38 S
NTN	UCF 312 - 206 D 1

Figure MU 13 

Standard Duty
Flanged Cartridge Units - Cast Housing
Eccentric Locking Collar Type, Set Screws Type

2.3750 in	ID	60.33 mm
6.2992 in	SB	160.00 mm

Group No. FU 0417 - 1	
SLB	UCFC 212 - 38
ASAHI	UCFC 212 - 38
FYH	UCFC 212 - 38
NACHI	UCFC 212 - 38
NSK	UCFC 212 - 38 S
NTN	UCFC 212 - 206 D 1
RHP	FC 2 3/8

Group No. FU 0417 - 2	
SLB	UELFC 212 - 38
NACHI	UGFC 212 - 38 + ER
NTN	UELFC 212 - 206 D 1 W 3
RHP	FC 2 3/8 DEC

Figure MU 14		
<i>Standard Duty</i>		
<i>Two Bolts Flanged Units - Cast Housing</i>		
<i>Eccentric Locking Collar Type, Set Screws Type</i>		
2.3750 in	ID	60.33 mm
7.9528 in	SB	202.00 mm

Group No. FU 0418 - 1	
SLB	UCFT 212 - 38
RHP	SFT 2 3/8

Group No. FU 0418 - 2	
SLB	UELFT 212 - 38
NTN	UELFLU 212 - 206 D 1 W 3
RHP	SFT 2 3/8 DEC

Figure MU 15		
<i>Standard Duty</i>		
<i>Two Bolts Flanged Units - Cast Housing</i>		
<i>Eccentric Locking Collar Type, Set Screws Type</i>		
2.3750 in	ID	60.33 mm
7.9528 in	SB	202.00 mm

Group No. FU 0419 - 1	
SLB	UCFL 212 - 38
ASAHI	UCFL 212 - 38
FYH	UCFL 212 - 38
NACHI	UCFL 212 - 38
NSK	ULFL 212 - 38 S
NTN	UCFL 212 - 206 D 1

Group No. FU 0419 - 2	
SLB	UELFL 212 - 38
NACHI	UGFL 212 - 38 + ER
NTN	UELFL 212 - 206 D 1 W 3

Figure MU 22		
<i>Heavy Duty</i>		
<i>Two Bolts Flanged Units - Cast Housing</i>		
<i>Set Screws Type</i>		

2.3750 in	ID	60.33 mm
8.3465 in	SB	212.00 mm

Group No. FU 0420 - 1	
SLB	UCFL 312 - 38
ASAHI	UCFL 312 - 38
NSK	UCFL 312 - 38 S
NTN	UCFL 312 - 206 D 1

Figure MU 11		
<i>Standard Duty</i>		
<i>Flanged Units - Cast Housing</i>		
<i>Eccentric Locking Collar Type, Set Screws Type</i>		
2.3750 in	ID	60.33 mm
5.6299 in	SB	143.0 mm

2.3750 in	ID	60.33 mm
5.6299 in	SB	143.0 mm

Group No. FU 0421 - 1	
SLB	UCFS 212 - 38
ASAHI	UCLF 212 - 38
FYH	SLF 212 - 38
LINK BELT	F 3 - U 238 N
RHP	SF 2 3/8

Group No. FU 0421 - 2	
SLB	UELFS 212 - 38
FAFNIR	RCJ - 2 - 3/8
LINK BELT	F 3 - Y 238 N
NTN	UELFU 212 - 206 D 1 W 3
RHP	SF 2 3/8 DEC

Figure MU 12		
<i>Standard Duty</i>		
<i>Flanged Units - Cast Housing</i>		
<i>Eccentric Locking Collar Type, Set Screws Type</i>		
2.4375 in	ID	61.91 mm
5.6299 in	SB	143.00 mm

2.4375 in	ID	61.91 mm
5.6299 in	SB	143.00 mm

Group No. FU 0422 - 1	
SLB	UCF 212 - 39
ASAHI	UCF 212 - 39
BROWNING	VF 4 S - 239
FAG	FG 56212.207
FYH	UCF 212 - 39
INA	RCJY 2 7/16"
KOYO	UCF 212 - 39
NACHI	UCF 212 - 39
NTN	UCF 212 - 207 D 1
SEALMASTER	SF - 39
SKF	FY 2 - 7/16 TM

Group No. FU 0422 - 2	
SLB	UELF 212 - 39
INA	RCJ 2 7/16"
NACHI	UGF 212 - 39 + ER
NTN	UELF 212 - 207 D 1 W 3
SKF	FY 2 - 7/16 WM

Figure MU 19		
<i>Medium Duty</i>		
<i>Flanged Units - Cast Housing</i>		
<i>Set Screws Type</i>		
2.4375 in	ID	61.91 mm
5.8661 in	SB	149.00 mm

2.4375 in	ID	61.91 mm
5.8661 in	SB	149.00 mm

Group No. FU 0423 - 1	
SLB	UCF X12 - 39
ASAHI	UCF X12 - 39
BROWNING	VF 4 S - 339
FYH	UCF X12 - 39
NTN	UCF X12 - 207 D 1
RHP	MSF 2 7/16
SEALMASTER	MSF - 39
SNR	MSF 2 7/16

Figure MU 21		
<i>Heavy Duty</i>		
<i>Flanged Units - Cast Housing</i>		
<i>Set Screws Type</i>		
2.4375 in	ID	61.91 mm
5.9055 in	SB	150.00 mm

2.4375 in	ID	61.91 mm
5.9055 in	SB	150.00 mm

Group No. FU 0424 - 1	
SLB	UCF 312 - 39
NTN	UCF 312 - 207 D 1

Figure MU 13		
<i>Standard Duty</i>		
<i>Flanged Cartridge Units - Cast Housing</i>		
<i>Eccentric Locking Collar Type, Set Screws Type</i>		
2.4375 in	ID	61.91 mm
6.2992 in	SB	160.00 mm

2.4375 in	ID	61.91 mm
6.2992 in	SB	160.00 mm

Group No. FU 0425 - 1	
SLB	UCFC 212 - 39
ASAHI	UCFC 212 - 39
FYH	UCFC 212 - 39
INA	RMEY 2 7/16"
NACHI	UCFC 212 - 39
NTN	UCFC 212 - 207 D 1
RHP	FC 2 7/16

Group No. FU 0425 - 2	
SLB	UELFC 212 - 39
NACHI	UGFC 212 - 39 + ER
NTN	UELFC 212 - 207 D 1 W 3
RHP	FC 2 7/16 DEC

Figure MU 14		
<i>Standard Duty</i>		
<i>Two Bolts Flanged Units - Cast Housing</i>		
<i>Eccentric Locking Collar Type, Set Screws Type</i>		

2.4375 in	ID	61.91 mm
7.9528 in	SB	202.00 mm

Group No. FU 0426 - 1

SLB	UCFT 212 - 39
RHP	SFT 2 7/16

Group No. FU 0426 - 2

SLB	UELFT 212 - 39
BROWNING	VF 2 E - 239
NTN	UELFU 212 - 207 D 1 W 3
RHP	SFT 2 7/16 DEC

FYH	SLF 212 - 39
LINK BELT	F 3 - U 239 N
RHP	SF 2 7/16

Group No. FU 0429 - 2

SLB	UELFS 212 - 39
BROWNING	VF 4 E - 239
FAFNIR	RCJ - 2 - 7/16
LINK BELT	F 3 - Y 239 N
NTN	UELFU 212 - 207 D 1 W 3
RHP	SF 2 7/16 DEC

Figure MU 21
Heavy Duty
 Flanged Units - Cast Housing
 Set Screws Type

2.5000 in	ID	63.50 mm
6.5354 in	SB	166.00 mm

Group No. FU 0432 - 1

SLB	UCF 313 - 40
ASAHI	UCF 313 - 40
FYH	UCF 313 - 40
NSK	UCF 313 - 40 S
NTN	UCF 313 - 208 D 1

Figure MU 15
Standard Duty
 Two Bolts Flanged Units - Cast Housing
 Eccentric Locking Collar Type, Set Screws Type

2.4375 in	ID	61.91 mm
7.9528 in	SB	202.00 mm

Group No. FU 0427 - 1

SLB	UCFL 212 - 39
ASAHI	UCFL 212 - 39
BROWNING	VF 2 S - 239
FYH	UCFL 212 - 39
INA	RCJTY 2 7/16"
NACHI	UCFL 212 - 39
NTN	UCFL 212 - 207 D 1

Group No. FU 0427 - 2

SLB	UELFL 212 - 39
INA	RCJT 2 7/16"
NACHI	UGFL 212 - 39 + ER
NTN	UELFL 212 - 207 D 1 W 3

Figure MU 12
Standard Duty
 Flanged Units - Cast Housing
 Eccentric Locking Collar Type, Set Screws Type

2.5000 in	ID	63.50 mm
5.8661 in	SB	149.00 mm

Group No. FU 0430 - 1

SLB	UCF 213 - 40
ASAHI	UCF 213 - 40
FYH	UCF 213 - 40
INA	RCJY 2 1/2" - 213
KOYO	UCF 213 - 40
NACHI	UCF 213 - 40
NSK	UCF 213 - 40 S
NTN	UCF 213 - 208 D 1
SEALMASTER	SF - 40
SKF	FY 2 - 1/2 TM

Group No. FU 0430 - 2

SLB	UELF 213 - 40
NTN	UELF 213 - 208 D 1 W 3

Figure MU 13
Standard Duty
 Flanged Cartridge Units - Cast Housing
 Eccentric Locking Collar Type, Set Screws Type

2.5000 in	ID	63.50 mm
6.6929 in	SB	170.00 mm

Group No. FU 0433 - 1

SLB	UCFC 213 - 40
ASAHI	UCFC 213 - 40
FYH	UCFC 213 - 40
INA	RMEY 2 1/2" - 213
NACHI	UCFC 213 - 40
NSK	UCFC 213 - 40 S
NTN	UCFC 213 - 208 D 1

Group No. FU 0433 - 2

SLB	UELFC 213 - 40
NTN	UELFC 213 - 208 D 1 W 3

Figure MU 22
Heavy Duty
 Two Bolts Flanged Units - Cast Housing
 Set Screws Type

2.4375 in	ID	61.91 mm
8.3465 in	SB	212.00 mm

Group No. FU 0428 - 1

SLB	UCFL 312 - 39
NTN	UCFL 312 - 207 D 1

Figure MU 19
Medium Duty
 Flanged Units - Cast Housing
 Set Screws Type

2.5000 in	ID	63.50 mm
5.8661 in	SB	149.00 mm

Group No. FU 0431 - 1

SLB	UCF X13 - 40
ASAHI	UCF X13 - 40
BROWNING	VF 4 S - 340
FYH	UCF X13 - 40
INA	RCJY 2 1/2" - MP
NTN	UCF X13 - 208 D 1
RHP	MSF 2 1/2
SEALMASTER	MSF - 40
SKF	FYM 2 - 1/2 TM
SNR	MSF 2 1/2

Figure MU 14
Standard Duty
 Two Bolts Flanged Units - Cast Housing
 Eccentric Locking Collar Type, Set Screws Type

2.5000 in	ID	63.50 mm
8.2677 in	SB	210.00 mm

Group No. FU 0434 - 1

SLB	UCFT 213 - 40
FYH	UCFT 213 - 40

Group No. FU 0434 - 2

SLB	UELFT 213 - 40
NTN	UELFLU 213 - 208 D 1 W 3

Figure MU 11
Standard Duty
 Flanged Units - Cast Housing
 Eccentric Locking Collar Type, Set Screws Type

2.4375 in	ID	61.91 mm
5.6299 in	SB	143.0 mm

Group No. FU 0429 - 1

SLB	UCFS 212 - 39
ASAHI	UCLF 212 - 39

Figure MU 15
Standard Duty
 Two Bolts Flanged Units - Cast Housing
 Eccentric Locking Collar Type, Set Screws Type

2.5000 in	ID	63.50 mm
8.2677 in	SB	210.00 mm

Group No. FU 0435 - 1	
SLB	UCFL 213 - 40
ASAHI	UCFL 213 - 40
FYH	UCFL 213 - 40
NACHI	UCFL 213 - 40
NSK	ULFL 213 - 40 S
NTN	UCFL 213 - 208 D 1
Group No. FU 0435 - 2	
SLB	UELFL 213 - 40
NTN	UELFL 213 - 208 D 1 W 3

Figure MU 22		
<i>Heavy Duty</i>		
<i>Two Bolts Flanged Units - Cast Housing</i>		
<i>Set Screws Type</i>		
2.5000 in	ID	63.50 mm
9.4488 in	SB	240.00 mm
Group No. FU 0436 - 1		
SLB	UCFL 313 - 40	
ASAHI	UCFL 313 - 40	
FYH	UCFL 313 - 40	
NSK	UCFL 313 - 40 S	
NTN	UCFL 313 - 208 D 1	



Figure MU 11		
<i>Standard Duty</i>		
<i>Flanged Units - Cast Housing</i>		
<i>Eccentric Locking Collar Type, Set Screws Type</i>		
2.5000 in	ID	63.50 mm
5.8661 in	SB	149.0 mm
Group No. FU 0437 - 1		
SLB	UCFS 213 - 40	
LINK BELT	F 3 - U 240 N	
RHP	SF 2 1/2	
Group No. FU 0437 - 2		
SLB	UELFS 213 - 40	
NTN	UELFU 213 - 208 D 1 W 3	
RHP	SF 2 1/2 DEC	

Figure MU 12		
<i>Standard Duty</i>		
<i>Flanged Units - Cast Housing</i>		
<i>Eccentric Locking Collar Type, Set Screws Type</i>		
2.5591 in	ID	65.00 mm
5.8661 in	SB	149.00 mm
Group No. FU 0438 - 1		
SLB	UCF 213	
ASAHI	UCF 213	
FYH	UCF 213	
INA	RCJY 65 - 213	

KOYO	UCF 213
NACHI	UCF 213
NSK	UCF 213
NTN	UCF 213 D 1
SKF	FY 65 TM
Group No. FU 0438 - 2	
SLB	UELF 213
NTN	UELF 213 D 1 W 3

Figure MU 19		
<i>Medium Duty</i>		
<i>Flanged Units - Cast Housing</i>		
<i>Set Screws Type</i>		
2.5591 in	ID	65.00 mm
5.8661 in	SB	149.00 mm
Group No. FU 0439 - 1		
SLB	UCF X13	
ASAHI	UCF X13	
FYH	UCF X13	
NSK	UCF X13	
NTN	UCF X13 D 1	
RHP	MSF 65	
SEALMASTER	MSF - 313	
SNR	MSF 65	



Figure MU 21		
<i>Heavy Duty</i>		
<i>Flanged Units - Cast Housing</i>		
<i>Set Screws Type</i>		
2.5591 in	ID	65.00 mm
6.5354 in	SB	166.00 mm
Group No. FU 0440 - 1		
SLB	UCF 313	
ASAHI	UCF 313	
FYH	UCF 313	
NSK	UCF 313	
NTN	UCF 313 D 1	

Figure MU 13		
<i>Standard Duty</i>		
<i>Flanged Cartridge Units - Cast Housing</i>		
<i>Eccentric Locking Collar Type, Set Screws Type</i>		
2.5591 in	ID	65.00 mm
6.6929 in	SB	170.00 mm
Group No. FU 0441 - 1		
SLB	UCFC 213	
ASAHI	UCFC 213	
FYH	UCFC 213	
INA	RMEY 65 - 213	
NACHI	UCFC 213	
NSK	UCFC 213	
NTN	UCFC 213 D 1	

Group No. FU 0441 - 2	
SLB	UELFC 213
NTN	UELFC 213 D 1 W 3

Figure MU 14		
<i>Standard Duty</i>		
<i>Two Bolts Flanged Units - Cast Housing</i>		
<i>Eccentric Locking Collar Type, Set Screws Type</i>		
2.5591 in	ID	65.00 mm
8.2677 in	SB	210.00 mm
Group No. FU 0442 - 1		
SLB	UCFT 213	
FYH	UCFT 213	
Group No. FU 0442 - 2		
SLB	UELFT 213	
NTN	UELFLU 213 D 1 W 3	

Figure MU 15		
<i>Standard Duty</i>		
<i>Two Bolts Flanged Units - Cast Housing</i>		
<i>Eccentric Locking Collar Type, Set Screws Type</i>		
2.5591 in	ID	65.00 mm
8.2677 in	SB	210.00 mm
Group No. FU 0443 - 1		
SLB	UCFL 213	
ASAHI	UCFL 213	
FYH	UCFL 213	
NACHI	UCFL 213	
NSK	ULFL 213	
NTN	UCFL 213 D 1	
Group No. FU 0443 - 2		
SLB	UELFL 213	
NTN	UELFL 213 D 1 W 3	



Figure MU 22		
<i>Heavy Duty</i>		
<i>Two Bolts Flanged Units - Cast Housing</i>		
<i>Set Screws Type</i>		
2.5591 in	ID	65.00 mm
9.4488 in	SB	240.00 mm
Group No. FU 0444 - 1		
SLB	UCFL 313	
ASAHI	UCFL 313	
FYH	UCFL 313	
NSK	UCFL 313	
NTN	UCFL 313 D 1	

Figure MU 11 
Standard Duty
Flanged Units - Cast Housing
Eccentric Locking Collar Type, Set Screws Type

2.5591 in	ID	65.00 mm
5.8661 in	SB	149.0 mm

Group No. FU 0445 - 1

SLB	UCFS 213
LINK BELT	F 3 - U 2 M 65 N
RHP	SF 65

Group No. FU 0445 - 2

SLB	UELFS 213
NTN	UELFU 213 D 1 W 3
RHP	SF 65 DEC

Figure MU 13 
Standard Duty
Flanged Cartridge Units - Cast Housing
Eccentric Locking Collar Type, Set Screws Type

2.5625 in	ID	65.09 mm
6.6929 in	SB	170.00 mm

Group No. FU 0449 - 1

SLB	UCFC 213 - 41
NTN	UCFC 213 - 209 D 1

Group No. FU 0449 - 2

SLB	UELFC 213 - 41
NTN	UELFC 213 - 209 D 1 W 3

Figure MU 11 
Standard Duty
Flanged Units - Cast Housing
Eccentric Locking Collar Type, Set Screws Type

2.5625 in	ID	65.09 mm
5.8661 in	SB	149.0 mm

Group No. FU 0453 - 1

SLB	UCFS 213 - 41
FYH	UCFS 213 - 41

Group No. FU 0453 - 2

SLB	UELFS 213 - 41
NTN	UELFU 213 - 209 D 1 W 3

Figure MU 12 
Standard Duty
Flanged Units - Cast Housing
Eccentric Locking Collar Type, Set Screws Type

2.5625 in	ID	65.09 mm
5.8661 in	SB	149.00 mm

Group No. FU 0446 - 1

SLB	UCF 213 - 41
NTN	UCF 213 - 209 D 1

Group No. FU 0446 - 2

SLB	UELF 213 - 41
NTN	UELF 213 - 209 D 1 W 3

Figure MU 14 
Standard Duty
Two Bolts Flanged Units - Cast Housing
Eccentric Locking Collar Type, Set Screws Type

2.5625 in	ID	65.09 mm
8.2677 in	SB	210.00 mm

Group No. FU 0450 - 1

SLB	UCFT 213 - 41
FYH	UCFT 213 - 41

Group No. FU 0450 - 2

SLB	UELFT 213 - 41
NTN	UELFU 213 - 209 D 1 W 3

Figure MU 12 
Standard Duty
Flanged Units - Cast Housing
Eccentric Locking Collar Type, Set Screws Type

2.6250 in	ID	66.68 mm
5.9843 in	SB	152.00 mm

Group No. FU 0454 - 1

SLB	UCF 214 - 42
NTN	UCF 214 - 210 D 1

Group No. FU 0454 - 2

SLB	UELF 214 - 42
NTN	UELF 214 - 210 D 1 W 3

Figure MU 19 
Medium Duty
Flanged Units - Cast Housing
Set Screws Type

2.5625 in	ID	65.09 mm
5.8661 in	SB	149.00 mm

Group No. FU 0447 - 1

SLB	UCF X13 - 41
NTN	UCF X13 - 209 D 1

Figure MU 15 
Standard Duty
Two Bolts Flanged Units - Cast Housing
Eccentric Locking Collar Type, Set Screws Type

2.5625 in	ID	65.09 mm
8.2677 in	SB	210.00 mm

Group No. FU 0451 - 1

SLB	UCFL 213 - 41
NTN	UCFL 213 - 209 D 1

Group No. FU 0451 - 2

SLB	UELFL 213 - 41
NTN	UELFL 213 - 209 D 1 W 3

Figure MU 19 
Medium Duty
Flanged Units - Cast Housing
Set Screws Type

2.6250 in	ID	66.68 mm
5.9843 in	SB	152.00 mm

Group No. FU 0455 - 1

SLB	UCF X14 - 42
NTN	UCF X14 - 210 D 1

Figure MU 21 
Heavy Duty
Flanged Units - Cast Housing
Set Screws Type

2.5625 in	ID	65.09 mm
6.5354 in	SB	166.00 mm

Group No. FU 0448 - 1

SLB	UCF 313 - 41
NTN	UCF 313 - 209 D 1

Figure MU 22 
Heavy Duty
Two Bolts Flanged Units - Cast Housing
Set Screws Type

2.5625 in	ID	65.09 mm
9.4488 in	SB	240.00 mm

Group No. FU 0452 - 1

SLB	UCFL 313 - 41
NTN	UCFL 313 - 209 D 1

Figure MU 13 
Standard Duty
Flanged Cartridge Units - Cast Housing
Eccentric Locking Collar Type, Set Screws Type

2.6250 in	ID	66.68 mm
6.9685 in	SB	177.00 mm

Group No. FU 0456 - 1

SLB	UCFC 214 - 42
NTN	UCFC 214 - 210 D 1

Group No. FU 0456 - 2

SLB	UELFC 214 - 42
NTN	UELFC 214 - 210 D 1 W 3

Figure MU 21 

Heavy Duty
Flanged Units - Cast Housing
Set Screws Type

2.6250 in	ID	66.68 mm
7.0079 in	SB	178.00 mm

Group No. FU 0457 - 1

SLB	UCF 314 - 42
NTN	UCF 314 - 210 D 1

Figure MU 14 

Standard Duty
Two Bolts Flanged Units - Cast Housing
Eccentric Locking Collar Type, Set Screws Type

2.6250 in	ID	66.68 mm
8.5039 in	SB	216.00 mm

Group No. FU 0458 - 1

SLB	UCFT 214 - 42
FYH	UCFT 214 - 42

Group No. FU 0458 - 2

SLB	UELFT 214 - 42
NTN	UELFLU 214 - 210 D 1 W 3

Figure MU 15 

Standard Duty
Two Bolts Flanged Units - Cast Housing
Eccentric Locking Collar Type, Set Screws Type

2.6250 in	ID	66.68 mm
8.5039 in	SB	216.00 mm

Group No. FU 0459 - 1

SLB	UCFL 214 - 42
NTN	UCFL 214 - 210 D 1

Group No. FU 0459 - 2

SLB	UELFL 214 - 42
NTN	UELFL 214 - 210 D 1 W 3

Figure MU 22 

Heavy Duty
Two Bolts Flanged Units - Cast Housing
Set Screws Type

2.6250 in	ID	66.68 mm
9.8425 in	SB	250.00 mm

Group No. FU 0460 - 1

SLB	UCFL 314 - 42
NTN	UCFL 314 - 210 D 1

Figure MU 11 

Standard Duty
Flanged Units - Cast Housing
Eccentric Locking Collar Type, Set Screws Type

2.6250 in	ID	66.68 mm
5.9843 in	SB	152.0 mm

Group No. FU 0461 - 1

SLB	UCFS 214 - 42
FYH	UCFS 214 - 42

Group No. FU 0461 - 2

SLB	UELFS 214 - 42
NTN	UELFU 214 - 210 D 1 W 3

Figure MU 12 

Standard Duty
Flanged Units - Cast Housing
Eccentric Locking Collar Type, Set Screws Type

2.6875 in	ID	68.26 mm
5.9843 in	SB	152.00 mm

Group No. FU 0462 - 1

SLB	UCF 214 - 43
BROWNING	VF 4 S - 243
NTN	UCF 214 - 211 D 1
SEALMASTER	SF - 43

Group No. FU 0462 - 2

SLB	UELF 214 - 43
NTN	UELF 214 - 211 D 1 W 3

Figure MU 19 

Medium Duty
Flanged Units - Cast Housing
Set Screws Type

2.6875 in	ID	68.26 mm
5.9843 in	SB	152.00 mm

Group No. FU 0463 - 1

SLB	UCF X14 - 43
ASAHI	UCF X14 - 43
BROWNING	VF 4 S - 343
NACHI	UCF X14 - 43
NTN	UCF X14 - 211 D 1
RHP	MSF 2 11/16
SEALMASTER	MSF - 43
SKF	FYM 2 - 11/16 TM
SNR	MSF 2 11/16

Figure MU 13 

Standard Duty
Flanged Cartridge Units - Cast Housing
Eccentric Locking Collar Type, Set Screws Type

2.6875 in	ID	68.26 mm
6.9685 in	SB	177.00 mm

Group No. FU 0464 - 1

SLB	UCFC 214 - 43
NTN	UCFC 214 - 211 D 1

Group No. FU 0464 - 2

SLB	UELFC 214 - 43
NTN	UELFC 214 - 211 D 1 W 3

Figure MU 21 

Heavy Duty
Flanged Units - Cast Housing
Set Screws Type

2.6875 in	ID	68.26 mm
7.0079 in	SB	178.00 mm

Group No. FU 0465 - 1

SLB	UCF 314 - 43
NTN	UCF 314 - 211 D 1

Figure MU 14 

Standard Duty
Two Bolts Flanged Units - Cast Housing
Eccentric Locking Collar Type, Set Screws Type

2.6875 in	ID	68.26 mm
8.5039 in	SB	216.00 mm

Group No. FU 0466 - 1

SLB	UCFT 214 - 43
FYH	UCFT 214 - 43

Group No. FU 0466 - 2

SLB	UELFT 214 - 43
BROWNING	VF 2 E - 243
NTN	UELFLU 214 - 211 D 1 W 3

Figure MU 15 

Standard Duty
Two Bolts Flanged Units - Cast Housing
Eccentric Locking Collar Type, Set Screws Type

2.6875 in	ID	68.26 mm
8.5039 in	SB	216.00 mm

Group No. FU 0467 - 1

SLB	UCFL 214 - 43
BROWNING	VF 2 S - 243
NTN	UCFL 214 - 211 D 1

Group No. FU 0467 - 2

SLB	UELFL 214 - 43
NTN	UELFL 214 - 211 D 1 W 3

Figure MU 22 
Heavy Duty
 Two Bolts Flanged Units - Cast Housing
 Set Screws Type

2.6875 in	ID	68.26 mm
9.8425 in	SB	250.00 mm

Group No. FU 0468 - 1

SLB	UCFL 314 - 43
NTN	UCFL 314 - 211 D 1

Figure MU 11 
Standard Duty
 Flanged Units - Cast Housing
 Eccentric Locking Collar Type, Set Screws Type

2.6875 in	ID	68.26 mm
5.9843 in	SB	152.0 mm

Group No. FU 0469 - 1

SLB	UCFS 214 - 43
LINK BELT	F 3 - U 243 N
RHP	SF 2 11/16

Group No. FU 0469 - 2

SLB	UELFS 214 - 43
BROWNING	VF 4 E - 243
NTN	UELFU 214 - 211 D 1 W 3
RHP	SF 2 11/16 DEC

Figure MU 12 
Standard Duty
 Flanged Units - Cast Housing
 Eccentric Locking Collar Type, Set Screws Type

2.7500 in	ID	69.85 mm
5.9843 in	SB	152.00 mm

Group No. FU 0470 - 1

SLB	UCF 214 - 44
ASAHI	UCF 214 - 44
FYH	UCF 214 - 44
NACHI	UCF 214 - 44
NSK	UCF 214 - 44 S
NTN	UCF 214 - 212 D 1

Group No. FU 0470 - 2

SLB	UELF 214 - 44
NTN	UELF 214 - 212 D 1 W 3

Figure MU 19 
Medium Duty
 Flanged Units - Cast Housing
 Set Screws Type

2.7500 in	ID	69.85 mm
5.9843 in	SB	152.00 mm

Group No. FU 0471 - 1

SLB	UCF X14 - 44
ASAHI	UCF X14 - 44
FYH	UCF X14 - 44
NACHI	UCF X14 - 44
NTN	UCF X14 - 212 D 1
RHP	MSF 2 3/4
SNR	MSF 2 3/4

Figure MU 13 
Standard Duty
 Flanged Cartridge Units - Cast Housing
 Eccentric Locking Collar Type, Set Screws Type

2.7500 in	ID	69.85 mm
6.9685 in	SB	177.00 mm

Group No. FU 0472 - 1

SLB	UCFC 214 - 44
ASAHI	UCFC 214 - 44
FYH	UCFC 214 - 44
NACHI	UCFC 214 - 44
NSK	UCFC 214 - 44 S
NTN	UCFC 214 - 212 D 1

Group No. FU 0472 - 2

SLB	UELFC 214 - 44
NTN	UELFC 214 - 212 D 1 W 3

Figure MU 21 
Heavy Duty
 Flanged Units - Cast Housing
 Set Screws Type

2.7500 in	ID	69.85 mm
7.0079 in	SB	178.00 mm

Group No. FU 0473 - 1

SLB	UCF 314 - 44
ASAHI	UCF 314 - 44
FYH	UCF 314 - 44
NACHI	UCF 314 - 44
NSK	UCF 314 - 44 S
NTN	UCF 314 - 212 D 1

Figure MU 14 
Standard Duty
 Two Bolts Flanged Units - Cast Housing
 Eccentric Locking Collar Type, Set Screws Type

2.7500 in	ID	69.85 mm
8.5039 in	SB	216.00 mm

Group No. FU 0474 - 1

SLB	UCFT 214 - 44
FYH	UCFT 214 - 44

Group No. FU 0474 - 2

SLB	UELFT 214 - 44
NTN	UELFU 214 - 212 D 1 W 3

Figure MU 15 
Standard Duty
 Two Bolts Flanged Units - Cast Housing
 Eccentric Locking Collar Type, Set Screws Type

2.7500 in	ID	69.85 mm
8.5039 in	SB	216.00 mm

Group No. FU 0475 - 1

SLB	UCFL 214 - 44
ASAHI	UCFL 214 - 44
FYH	UCFL 214 - 44
NACHI	UCFL 214 - 44
NSK	ULFL 214 - 44 S
NTN	UCFL 214 - 212 D 1

Group No. FU 0475 - 2

SLB	UELFL 214 - 44
NTN	UELFL 214 - 212 D 1 W 3

Figure MU 22 
Heavy Duty
 Two Bolts Flanged Units - Cast Housing
 Set Screws Type

2.7500 in	ID	69.85 mm
9.8425 in	SB	250.00 mm

Group No. FU 0476 - 1

SLB	UCFL 314 - 44
ASAHI	UCFL 314 - 44
FYH	UCFL 314 - 44
NSK	UCFL 314 - 44 S
NTN	UCFL 314 - 212 D 1

Figure MU 11 
Standard Duty
 Flanged Units - Cast Housing
 Eccentric Locking Collar Type, Set Screws Type

2.7500 in	ID	69.85 mm
5.9843 in	SB	152.0 mm

Group No. FU 0477 - 1

SLB	UCFS 214 - 44
FYH	SLF 214 - 44
LINK BELT	F 3 - U 244 N
RHP	SF 2 3/4

Group No. FU 0477 - 2

SLB	UELFS 214 - 44
NTN	UELFU 214 - 212 D 1 W 3
RHP	SF 2 3/4 DEC

Figure MU 12 

Standard Duty
Flanged Units - Cast Housing
Eccentric Locking Collar Type, Set Screws Type

2.7559 in	ID	70.00 mm
5.9843 in	SB	152.00 mm

Group No. FU 0478 - 1

SLB	UCF 214
ASAHI	UCF 214
FYH	UCF 214
INA	RCJY 70
NACHI	UCF 214
NSK	UCF 214
NTN	UCF 214 D 1
SEALMASTER	SF - 214
SKF	FY 70 TM

Group No. FU 0478 - 2

SLB	UELF 214
INA	RCJ 70 S
NTN	UELF 214 D 1 W 3

Figure MU 19 

Medium Duty
Flanged Units - Cast Housing
Set Screws Type

2.7559 in	ID	70.00 mm
5.9843 in	SB	152.00 mm

Group No. FU 0479 - 1

SLB	UCF X14
ASAHI	UCF X14
FYH	UCF X14
NACHI	UCF X14
NSK	UCF X14
NTN	UCF X14 D 1
RHP	MSF 70
SEALMASTER	MSF - 314
SNR	MSF 70

Figure MU 13 

Standard Duty
Flanged Cartridge Units - Cast Housing
Eccentric Locking Collar Type, Set Screws Type

2.7559 in	ID	70.00 mm
6.9685 in	SB	177.00 mm

Group No. FU 0480 - 1

SLB	UCFC 214
ASAHI	UCFC 214
FYH	UCFC 214
INA	RMEY 70
NACHI	UCFC 214
NSK	UCFC 214
NTN	UCFC 214 D 1

Group No. FU 0480 - 2

SLB	UELFC 214
INA	RME 70 S
NTN	UELFC 214 D 1 W 3

Figure MU 21 

Heavy Duty
Flanged Units - Cast Housing
Set Screws Type

2.7559 in	ID	70.00 mm
7.0079 in	SB	178.00 mm

Group No. FU 0481 - 1

SLB	UCF 314
ASAHI	UCF 314
FYH	UCF 314
NACHI	UCF 314
NSK	UCF 314
NTN	UCF 314 D 1

Figure MU 14 

Standard Duty
Two Bolts Flanged Units - Cast Housing
Eccentric Locking Collar Type, Set Screws Type

2.7559 in	ID	70.00 mm
8.5039 in	SB	216.00 mm

Group No. FU 0482 - 1

SLB	UCFT 214
FYH	UCFT 214

Group No. FU 0482 - 2

SLB	UELFT 214
NTN	UELFLU 214 D 1 W 3

Figure MU 15 

Standard Duty
Two Bolts Flanged Units - Cast Housing
Eccentric Locking Collar Type, Set Screws Type

2.7559 in	ID	70.00 mm
8.5039 in	SB	216.00 mm

Group No. FU 0483 - 1

SLB	UCFL 214
ASAHI	UCFL 214
FYH	UCFL 214
INA	RCJTY 70
NACHI	UCFL 214
NSK	ULFL 214
NTN	UCFL 214 D 1

Group No. FU 0483 - 2

SLB	UELFL 214
INA	RCJT 70 S
NTN	UELFL 214 D 1 W 3

Figure MU 22 

Heavy Duty
Two Bolts Flanged Units - Cast Housing
Set Screws Type

2.7559 in	ID	70.00 mm
9.8425 in	SB	250.00 mm

Group No. FU 0484 - 1

SLB	UCFL 314
ASAHI	UCFL 314
FYH	UCFL 314
NSK	UCFL 314
NTN	UCFL 314 D 1

Figure MU 11 

Standard Duty
Flanged Units - Cast Housing
Eccentric Locking Collar Type, Set Screws Type

2.7559 in	ID	70.00 mm
5.9843 in	SB	152.0 mm

Group No. FU 0485 - 1

SLB	UCFS 214
FYH	SLF 214
RHP	SF 70

Group No. FU 0485 - 2

SLB	UELFS 214
NTN	UELFU 214 D 1 W 3
RHP	SF 70 DEC

Figure MU 19 

Medium Duty
Flanged Units - Cast Housing
Set Screws Type

2.8125 in	ID	71.44 mm
5.9843 in	SB	152.00 mm

Group No. FU 0486 - 1

SLB	UCF X15 - 45
NTN	UCF X15 - 213 D 1

Figure MU 12 

Standard Duty
Flanged Units - Cast Housing
Eccentric Locking Collar Type, Set Screws Type

2.8125 in	ID	71.44 mm
6.2598 in	SB	159.00 mm

Group No. FU 0487 - 1

SLB	UCF 215 - 45
NTN	UCF 215 - 213 D 1

Group No. FU 0487 - 2		
SLB	UELF 215 - 45	
NTN	UELF 215 - 213 D 1 W 3	

Group No. FU 0491 - 1		
SLB	UCFL 315 - 45	
NTN	UCFL 315 - 213 D 1	

Group No. FU 0495 - 2		
SLB	UELFC 215 - 46	
NTN	UELFC 215 - 214 D 1 W 3	

Figure MU 13 		
<i>Standard Duty</i>		
<i>Flanged Cartridge Units - Cast Housing</i>		
<i>Eccentric Locking Collar Type, Set Screws Type</i>		
2.8125 in	ID	71.44 mm
7.2441 in	SB	184.00 mm



Figure MU 11 		
<i>Standard Duty</i>		
<i>Flanged Units - Cast Housing</i>		
<i>Eccentric Locking Collar Type, Set Screws Type</i>		
2.8125 in	ID	71.44 mm
6.0000 in	SB	152.4 mm

Figure MU 21 		
<i>Heavy Duty</i>		
<i>Flanged Units - Cast Housing</i>		
<i>Set Screws Type</i>		
2.8750 in	ID	73.03 mm
7.2441 in	SB	184.00 mm

Group No. FU 0488 - 1		
SLB	UCFC 215 - 45	
NTN	UCFC 215 - 213 D 1	

Group No. FU 0492 - 1		
SLB	UCFS 215 - 45	
FYH	UCFS 215 - 45	

Group No. FU 0496 - 1		
SLB	UCF 315 - 46	
NTN	UCF 315 - 214 D 1	

Group No. FU 0488 - 2		
SLB	UELFC 215 - 45	
NTN	UELFC 215 - 213 D 1 W 3	

Figure MU 19 		
<i>Medium Duty</i>		
<i>Flanged Units - Cast Housing</i>		
<i>Set Screws Type</i>		
2.8750 in	ID	73.03 mm
5.9843 in	SB	152.00 mm



Figure MU 15 		
<i>Standard Duty</i>		
<i>Two Bolts Flanged Units - Cast Housing</i>		
<i>Eccentric Locking Collar Type, Set Screws Type</i>		
2.8750 in	ID	73.03 mm
8.8583 in	SB	225.00 mm

Figure MU 21 		
<i>Heavy Duty</i>		
<i>Flanged Units - Cast Housing</i>		
<i>Set Screws Type</i>		
2.8125 in	ID	71.44 mm
7.2441 in	SB	184.00 mm

Group No. FU 0493 - 1		
SLB	UCF X15 - 46	
NTN	UCF X15 - 214 D 1	

Group No. FU 0497 - 1		
SLB	UCFL 215 - 46	
NTN	UCFL 215 - 214 D 1	

Group No. FU 0489 - 1		
SLB	UCF 315 - 45	
NTN	UCF 315 - 213 D 1	

Figure MU 12 		
<i>Standard Duty</i>		
<i>Flanged Units - Cast Housing</i>		
<i>Eccentric Locking Collar Type, Set Screws Type</i>		
2.8750 in	ID	73.03 mm
6.2598 in	SB	159.00 mm

Group No. FU 0497 - 2		
SLB	UELFL 215 - 46	
NTN	UELFL 215 - 214 D 1 W 3	

Figure MU 15 		
<i>Standard Duty</i>		
<i>Two Bolts Flanged Units - Cast Housing</i>		
<i>Eccentric Locking Collar Type, Set Screws Type</i>		
2.8125 in	ID	71.44 mm
8.8583 in	SB	225.00 mm

Group No. FU 0494 - 1		
SLB	UCF 215 - 46	
NTN	UCF 215 - 214 D 1	
SEALMASTER	SF - 46	

Figure MU 22 		
<i>Heavy Duty</i>		
<i>Two Bolts Flanged Units - Cast Housing</i>		
<i>Set Screws Type</i>		
2.8750 in	ID	73.03 mm
10.2362 in	SB	260.00 mm

Group No. FU 0490 - 1		
SLB	UCFL 215 - 45	
NTN	UCFL 215 - 213 D 1	

Group No. FU 0494 - 2		
SLB	UELF 215 - 46	
NTN	UELF 215 - 214 D 1 W 3	

Group No. FU 0498 - 1		
SLB	UCFL 315 - 46	
NTN	UCFL 315 - 214 D 1	

Group No. FU 0490 - 2		
SLB	UELFL 215 - 45	
NTN	UELFL 215 - 213 D 1 W 3	

Figure MU 13 		
<i>Standard Duty</i>		
<i>Flanged Cartridge Units - Cast Housing</i>		
<i>Eccentric Locking Collar Type, Set Screws Type</i>		
2.8750 in	ID	73.03 mm
7.2441 in	SB	184.00 mm



Figure MU 11 		
<i>Standard Duty</i>		
<i>Flanged Units - Cast Housing</i>		
<i>Eccentric Locking Collar Type, Set Screws Type</i>		
2.8750 in	ID	73.03 mm
6.0000 in	SB	152.4 mm

Figure MU 22 		
<i>Heavy Duty</i>		
<i>Two Bolts Flanged Units - Cast Housing</i>		
<i>Set Screws Type</i>		
2.8125 in	ID	71.44 mm
10.2362 in	SB	260.00 mm

Group No. FU 0495 - 1		
SLB	UCFC 215 - 46	
NTN	UCFC 215 - 214 D 1	

Group No. FU 0499 - 1		
SLB	UCFS 215 - 46	
RHP	SF 2 7/8	

Group No. FU 0499 - 2	
SLB	UELFS 215 - 46
RHP	SF 2 7/8 DEC

Figure MU 19 
 Medium Duty
 Flanged Units - Cast Housing
 Set Screws Type

2.9375 in	ID	74.61 mm
5.9843 in	SB	152.00 mm

Group No. FU 0500 - 1	
SLB	UCF X15 - 47
ASAHI	UCF X15 - 47
BROWNING	VF 4 S - 347
NACHI	UCF X15 - 47
NTN	UCF X15 - 215 D 1
RHP	MSF 2 15/16
SEALMASTER	MSF - 47
SKF	FYM 2 - 15/16 TM
SNR	MSF 2 15/16

Figure MU 12 
 Standard Duty
 Flanged Units - Cast Housing
 Eccentric Locking Collar Type, Set Screws Type

2.9375 in	ID	74.61 mm
6.2598 in	SB	159.00 mm

Group No. FU 0501 - 1	
SLB	UCF 215 - 47
BROWNING	VF 4 S - 247
INA	RCJY 2 15/16"
NTN	UCF 215 - 215 D 1
SEALMASTER	SF - 47
SKF	FY 2 - 15/16 TM

Group No. FU 0501 - 2	
SLB	UELF 215 - 47
INA	RCJ 2 15/16" S
NTN	UELF 215 - 215 D 1 W 3

Figure MU 13 
 Standard Duty
 Flanged Cartridge Units - Cast Housing
 Eccentric Locking Collar Type, Set Screws Type

2.9375 in	ID	74.61 mm
7.2441 in	SB	184.00 mm

Group No. FU 0502 - 1	
SLB	UCFC 215 - 47
INA	RMEY 2 15/16"
NTN	UCFC 215 - 215 D 1

Group No. FU 0502 - 2	
SLB	UELFC 215 - 47
NTN	UELFC 215 - 215 D 1 W 3

Figure MU 21 
 Heavy Duty
 Flanged Units - Cast Housing
 Set Screws Type

2.9375 in	ID	74.61 mm
7.2441 in	SB	184.00 mm

Group No. FU 0503 - 1	
SLB	UCF 315 - 47
NTN	UCF 315 - 215 D 1

Figure MU 15 
 Standard Duty
 Two Bolts Flanged Units - Cast Housing
 Eccentric Locking Collar Type, Set Screws Type

2.9375 in	ID	74.61 mm
8.8583 in	SB	225.00 mm

Group No. FU 0504 - 1	
SLB	UCFL 215 - 47
BROWNING	VF 2 S - 247
INA	RCJTY 2 15/16"
NTN	UCFL 215 - 215 D 1

Group No. FU 0504 - 2	
SLB	UELFL 215 - 47
INA	RCJT 2 15/16" S
NTN	UELFL 215 - 215 D 1 W 3

Figure MU 22 
 Heavy Duty
 Two Bolts Flanged Units - Cast Housing
 Set Screws Type

2.9375 in	ID	74.61 mm
10.2362 in	SB	260.00 mm

Group No. FU 0505 - 1	
SLB	UCFL 315 - 47
NTN	UCFL 315 - 215 D 1

Figure MU 11 
 Standard Duty
 Flanged Units - Cast Housing
 Eccentric Locking Collar Type, Set Screws Type

2.9375 in	ID	74.61 mm
6.0000 in	SB	152.4 mm

Group No. FU 0506 - 1	
SLB	UCFS 215 - 47
LINK BELT	F 3 - U 247 N
RHP	SF 2 15/16

Group No. FU 0506 - 2	
SLB	UELFS 215 - 47
BROWNING	VF 4 E - 247
FAFNIR	RCJ - 2 - 15/16
RHP	SF 2 15/16 DEC

Figure MU 19 
 Medium Duty
 Flanged Units - Cast Housing
 Set Screws Type

2.9528 in	ID	75.00 mm
5.9843 in	SB	152.00 mm

Group No. FU 0507 - 1	
SLB	UCF X15
ASAHI	UCF X15
FYH	UCF X15
NACHI	UCF X15
NSK	UCF X15
NTN	UCF X15 D 1
RHP	MSF 75
SEALMASTER	MSF - 315
SNR	MSF 75

Figure MU 12 
 Standard Duty
 Flanged Units - Cast Housing
 Eccentric Locking Collar Type, Set Screws Type

2.9528 in	ID	75.00 mm
6.2598 in	SB	159.00 mm

Group No. FU 0508 - 1	
SLB	UCF 215
ASAHI	UCF 215
FYH	UCF 215
INA	RCJY 75
NACHI	UCF 215
NSK	UCF 215
NTN	UCF 215 D 1
SEALMASTER	SF - 215
SKF	FY 75 TM

Group No. FU 0508 - 2	
SLB	UELF 215
INA	RCJ 75 S
NTN	UELF 215 D 1 W 3

Figure MU 13 
 Standard Duty
 Flanged Cartridge Units - Cast Housing
 Eccentric Locking Collar Type, Set Screws Type

2.9528 in	ID	75.00 mm
7.2441 in	SB	184.00 mm

Group No. FU 0509 - 1

SLB	UCFC 215
ASAHI	UCFC 215
FYH	UCFC 215
INA	RMEY 75
NACHI	UCFC 215
NSK	UCFC 215
NTN	UCFC 215 D 1

Group No. FU 0509 - 2

SLB	UELFC 215
INA	RME 75 S
NTN	UELFC 215 D 1 W 3

Figure MU 21

Heavy Duty
Flanged Units - Cast Housing
Set Screws Type

2.9528 in	ID	75.00 mm
7.2441 in	SB	184.00 mm

Group No. FU 0510 - 1

SLB	UCF 315
ASAHI	UCF 315
FYH	UCF 315
NACHI	UCF 315
NSK	UCF 315
NTN	UCF 315 D 1

Figure MU 15

Standard Duty
Two Bolts Flanged Units - Cast Housing
Eccentric Locking Collar Type, Set Screws Type

2.9528 in	ID	75.00 mm
8.8583 in	SB	225.00 mm

Group No. FU 0511 - 1

SLB	UCFL 215
ASAHI	UCFL 215
FYH	UCFL 215
INA	RCJTY 75
NACHI	UCFL 215
NSK	ULFL 215
NTN	UCFL 215 D 1

Group No. FU 0511 - 2

SLB	UELFL 215
INA	RCJT 75 S
NTN	UELFL 215 D 1 W 3

Figure MU 22

Heavy Duty
Two Bolts Flanged Units - Cast Housing
Set Screws Type

2.9528 in	ID	75.00 mm
10.2362 in	SB	260.00 mm

Group No. FU 0512 - 1

SLB	UCFL 315
ASAHI	UCFL 315
FYH	UCFL 315
NSK	UCFL 315
NTN	UCFL 315 D 1

Figure MU 11

Standard Duty
Flanged Units - Cast Housing
Eccentric Locking Collar Type, Set Screws Type

2.9528 in	ID	75.00 mm
6.0000 in	SB	152.4 mm

Group No. FU 0513 - 1

SLB	UCFS 215
FYH	SLF 215
LINK BELT	F 3 - U 2 M 75 N
RHP	SF 75

Group No. FU 0513 - 2

SLB	UELFS 215
FAFNIR	RCJ - 75
RHP	SF 75 DEC

Figure MU 19

Medium Duty
Flanged Units - Cast Housing
Set Screws Type

3.0000 in	ID	76.20 mm
5.9843 in	SB	152.00 mm

Group No. FU 0514 - 1

SLB	UCF X15 - 48
ASAHI	UCF X15 - 48
BROWNING	VF 4 S - 348
FYH	UCF X15 - 48
NACHI	UCF X15 - 48
NTN	UCF X15 - 300 D 1
RHP	MSF 3
SEALMASTER	MSF - 48
SKF	FYM 3 TM
SNR	MSF 3

Figure MU 12

Standard Duty
Flanged Units - Cast Housing
Eccentric Locking Collar Type, Set Screws Type

3.0000 in	ID	76.20 mm
6.2598 in	SB	159.00 mm

Group No. FU 0515 - 1

SLB	UCF 215 - 48
ASAHI	UCF 215 - 48
FYH	UCF 215 - 48
NACHI	UCF 215 - 48
NSK	UCF 215 - 48 S
NTN	UCF 215 - 300 D 1

Group No. FU 0515 - 2

SLB	UELFC 215 - 48
NTN	UELFC 215 - 300 D 1 W 3

Figure MU 13

Standard Duty
Flanged Cartridge Units - Cast Housing
Eccentric Locking Collar Type, Set Screws Type

3.0000 in	ID	76.20 mm
7.2441 in	SB	184.00 mm

Group No. FU 0516 - 1

SLB	UCFC 215 - 48
ASAHI	UCFC 215 - 48
FYH	UCFC 215 - 48
NACHI	UCFC 215 - 48
NSK	UCFC 215 - 48 S
NTN	UCFC 215 - 300 D 1

Group No. FU 0516 - 2

SLB	UELFC 215 - 48
NTN	UELFC 215 - 300 D 1 W 3

Figure MU 21

Heavy Duty
Flanged Units - Cast Housing
Set Screws Type

3.0000 in	ID	76.20 mm
7.2441 in	SB	184.00 mm

Group No. FU 0517 - 1

SLB	UCF 315 - 48
ASAHI	UCF 315 - 48
FYH	UCF 315 - 48
NACHI	UCF 315 - 48
NSK	UCF 315 - 48 S
NTN	UCF 315 - 300 D 1

Figure MU 15

Standard Duty
Two Bolts Flanged Units - Cast Housing
Eccentric Locking Collar Type, Set Screws Type

3.0000 in	ID	76.20 mm
8.8583 in	SB	225.00 mm

Group No. FU 0518 - 1	
SLB	UCFL 215 - 48
ASAHI	UCFL 215 - 48
FYH	UCFL 215 - 48
NACHI	UCFL 215 - 48
NSK	ULFL 215 - 48 S
NTN	UCFL 215 - 300 D 1

Group No. FU 0518 - 2	
SLB	UELFL 215 - 48
NTN	UELFL 215 - 300 D 1 W 3

Figure MU 22 
Heavy Duty
Two Bolts Flanged Units - Cast Housing
Set Screws Type

3.0000 in	ID	76.20 mm
10.2362 in	SB	260.00 mm

Group No. FU 0519 - 1	
SLB	UCFL 315 - 48
ASAHI	UCFL 315 - 48
FYH	UCFL 315 - 48
NSK	UCFL 315 - 48 S
NTN	UCFL 315 - 300 D 1

Figure MU 11 
Standard Duty
Flanged Units - Cast Housing
Eccentric Locking Collar Type, Set Screws Type

3.0000 in	ID	76.20 mm
6.0000 in	SB	152.4 mm

Group No. FU 0520 - 1	
SLB	UCFS 215 - 48
FYH	SLF 215 - 48
LINK BELT	F 3 - U 2 E 48 N
RHP	SF 3

Figure MU 12 
Standard Duty
Flanged Units - Cast Housing
Eccentric Locking Collar Type, Set Screws Type

3.0625 in	ID	77.79 mm
6.4961 in	SB	165.00 mm

Group No. FU 0521 - 1	
SLB	UCF 216 - 49
NTN	UCF 216 - 301 D 1

Figure MU 19 
Medium Duty
Flanged Units - Cast Housing
Set Screws Type

3.0625 in	ID	77.79 mm
6.7323 in	SB	171.00 mm

Group No. FU 0522 - 1	
SLB	UCF X16 - 49
NTN	UCF X16 - 301 D 1

Figure MU 21 
Heavy Duty
Flanged Units - Cast Housing
Set Screws Type

3.0625 in	ID	77.79 mm
7.7165 in	SB	196.00 mm

Group No. FU 0523 - 1	
SLB	UCF 316 - 49
NTN	UCF 316 - 301 D 1

Figure MU 13 
Standard Duty
Flanged Cartridge Units - Cast Housing
Eccentric Locking Collar Type, Set Screws Type

3.0625 in	ID	77.79 mm
7.8740 in	SB	200.00 mm

Group No. FU 0524 - 1	
SLB	UCFC 216 - 49
NTN	UCFC 216 - 301 D 1

Figure MU 15 
Standard Duty
Two Bolts Flanged Units - Cast Housing
Eccentric Locking Collar Type, Set Screws Type

3.0625 in	ID	77.79 mm
9.1732 in	SB	233.00 mm

Group No. FU 0525 - 1	
SLB	UCFL 216 - 49
NTN	UCFL 216 - 301 D 1

Figure MU 22 
Heavy Duty
Two Bolts Flanged Units - Cast Housing
Set Screws Type

3.0625 in	ID	77.79 mm
11.2205 in	SB	285.00 mm

Group No. FU 0526 - 1	
SLB	UCFL 316 - 49
NTN	UCFL 316 - 301 D 1

Figure MU 12 
Standard Duty
Flanged Units - Cast Housing
Eccentric Locking Collar Type, Set Screws Type

3.1250 in	ID	79.38 mm
6.4961 in	SB	165.00 mm

Group No. FU 0527 - 1	
SLB	UCF 216 - 50
ASAHI	UCF 216 - 50
NACHI	UCF 216 - 50
NSK	UCF 216 - 50 S
NTN	UCF 216 - 302 D 1

Figure MU 19 
Medium Duty
Flanged Units - Cast Housing
Set Screws Type

3.1250 in	ID	79.38 mm
6.7323 in	SB	171.00 mm

Group No. FU 0528 - 1	
SLB	UCF X16 - 50
NTN	UCF X16 - 302 D 1

Figure MU 21 
Heavy Duty
Flanged Units - Cast Housing
Set Screws Type

3.1250 in	ID	79.38 mm
7.7165 in	SB	196.00 mm

Group No. FU 0529 - 1	
SLB	UCF 316 - 50
ASAHI	UCF 316 - 50
NACHI	UCF 316 - 50
NSK	UCF 316 - 50 S
NTN	UCF 316 - 302 D 1

Figure MU 13 
Standard Duty
Flanged Cartridge Units - Cast Housing
Eccentric Locking Collar Type, Set Screws Type

3.1250 in	ID	79.38 mm
7.8740 in	SB	200.00 mm

Group No. FU 0530 - 1	
SLB	UCFC 216 - 50
ASAHI	UCFC 216 - 50
NACHI	UCFC 216 - 50
NSK	UCFC 216 - 50 S
NTN	UCFC 216 - 302 D 1

Figure MU 15 

Standard Duty
Two Bolts Flanged Units - Cast Housing
Eccentric Locking Collar Type, Set Screws Type

3.1250 in	ID	79.38 mm
9.1732 in	SB	233.00 mm

Group No. FU 0531 - 1

SLB	UCFL 216 - 50
ASAHI	UCFL 216 - 50
NACHI	UCFL 216 - 50
NSK	ULFL 216 - 50 S
NTN	UCFL 216 - 302 D 1

Figure MU 22 

Heavy Duty
Two Bolts Flanged Units - Cast Housing
Set Screws Type

3.1250 in	ID	79.38 mm
11.2205 in	SB	285.00 mm

Group No. FU 0532 - 1

SLB	UCFL 316 - 50
ASAHI	UCFL 316 - 50
NSK	UCFL 316 - 50 S
NTN	UCFL 316 - 302 D 1

Figure MU 12 

Standard Duty
Flanged Units - Cast Housing
Eccentric Locking Collar Type, Set Screws Type

3.1496 in	ID	80.00 mm
6.4961 in	SB	165.00 mm

Group No. FU 0533 - 1

SLB	UCF 216
ASAHI	UCF 216
FYH	UCF 216
INA	RCJY 80
NACHI	UCF 216
NSK	UCF 216
NTN	UCF 216 D 1
SKF	FY 80 TM

Figure MU 19 

Medium Duty
Flanged Units - Cast Housing
Set Screws Type

3.1496 in	ID	80.00 mm
6.7323 in	SB	171.00 mm

Group No. FU 0534 - 1

SLB	UCF X16
ASAHI	UCF X16
FYH	UCF X16
NACHI	UCF X16
NSK	UCF X16
NTN	UCF X16 D 1
RHP	MSF 80
SNR	MSF 80

Figure MU 21 

Heavy Duty
Flanged Units - Cast Housing
Set Screws Type

3.1496 in	ID	80.00 mm
7.7165 in	SB	196.00 mm

Group No. FU 0535 - 1

SLB	UCF 316
ASAHI	UCF 316
FYH	UCF 316
NACHI	UCF 316
NSK	UCF 316
NTN	UCF 316 D 1

Figure MU 13 

Standard Duty
Flanged Cartridge Units - Cast Housing
Eccentric Locking Collar Type, Set Screws Type

3.1496 in	ID	80.00 mm
7.8740 in	SB	200.00 mm

Group No. FU 0536 - 1

SLB	UCFC 216
ASAHI	UCFC 216
FYH	UCFC 216
INA	RMEY 80
NACHI	UCFC 216
NSK	UCFC 216
NTN	UCFC 216 D 1

Figure MU 15 

Standard Duty
Two Bolts Flanged Units - Cast Housing
Eccentric Locking Collar Type, Set Screws Type

3.1496 in	ID	80.00 mm
9.1732 in	SB	233.00 mm

Group No. FU 0537 - 1

SLB	UCFL 216
ASAHI	UCFL 216
FYH	UCFL 216
NACHI	UCFL 216
NSK	ULFL 216
NTN	UCFL 216 D 1

Figure MU 22 

Heavy Duty
Two Bolts Flanged Units - Cast Housing
Set Screws Type

3.1496 in	ID	80.00 mm
11.2205 in	SB	285.00 mm

Group No. FU 0538 - 1

SLB	UCFL 316
ASAHI	UCFL 316
FYH	UCFL 316
NSK	UCFL 316
NTN	UCFL 316 D 1

Figure MU 12 

Standard Duty
Flanged Units - Cast Housing
Eccentric Locking Collar Type, Set Screws Type

3.1875 in	ID	80.96 mm
6.4961 in	SB	165.00 mm

Group No. FU 0539 - 1

SLB	UCF 216 - 51
NTN	UCF 216 - 303 D 1

Figure MU 13 

Standard Duty
Flanged Cartridge Units - Cast Housing
Eccentric Locking Collar Type, Set Screws Type

3.1875 in	ID	80.96 mm
7.8740 in	SB	200.00 mm

Group No. FU 0540 - 1

SLB	UCFC 216 - 51
NTN	UCFC 216 - 303 D 1

Figure MU 15 

Standard Duty
Two Bolts Flanged Units - Cast Housing
Eccentric Locking Collar Type, Set Screws Type

3.1875 in	ID	80.96 mm
9.1732 in	SB	233.00 mm

Group No. FU 0541 - 1

SLB	UCFL 216 - 51
NTN	UCFL 216 - 303 D 1

Figure MU 12 

Standard Duty
Flanged Units - Cast Housing
Eccentric Locking Collar Type, Set Screws Type

3.2500 in	ID	82.55 mm
6.8898 in	SB	175.00 mm
Group No. FU 0542 - 1		
SLB	UCF 217 - 52	
ASAHI	UCF 217 - 52	
FYH	UCF 217 - 52	
NACHI	UCF 217 - 52	
NSK	UCF 217 - 52 S	
NTN	UCF 217 - 304 D 1	

Figure MU 13 

Standard Duty
Flanged Cartridge Units - Cast Housing
Eccentric Locking Collar Type, Set Screws Type

3.2500 in	ID	82.55 mm
8.1890 in	SB	208.00 mm
Group No. FU 0543 - 1		
SLB	UCFC 217 - 52	
ASAHI	UCFC 217 - 52	
FYH	UCFC 217 - 52	
NACHI	UCFC 217 - 52	
NSK	UCFC 217 - 52 S	
NTN	UCFC 217 - 304 D 1	

Figure MU 15 

Standard Duty
Two Bolts Flanged Units - Cast Housing
Eccentric Locking Collar Type, Set Screws Type

3.2500 in	ID	82.55 mm
9.7638 in	SB	248.00 mm
Group No. FU 0544 - 1		
SLB	UCFL 217 - 52	
ASAHI	UCFL 217 - 52	
FYH	UCFL 217 - 52	
NACHI	UCFL 217 - 52	
NSK	ULFL 217 - 52 S	
NTN	UCFL 217 - 304 D 1	

Figure MU 12 

Standard Duty
Flanged Units - Cast Housing
Eccentric Locking Collar Type, Set Screws Type

3.3125 in	ID	84.14 mm
6.8898 in	SB	175.00 mm
Group No. FU 0545 - 1		
SLB	UCF 217 - 53	
NTN	UCF 217 - 305 D 1	

Figure MU 13 

Standard Duty
Flanged Cartridge Units - Cast Housing
Eccentric Locking Collar Type, Set Screws Type

3.3125 in	ID	84.14 mm
8.1890 in	SB	208.00 mm
Group No. FU 0546 - 1		
SLB	UCFC 217 - 53	
NTN	UCFC 217 - 305 D 1	

Figure MU 15 

Standard Duty
Two Bolts Flanged Units - Cast Housing
Eccentric Locking Collar Type, Set Screws Type

3.3125 in	ID	84.14 mm
9.7638 in	SB	248.00 mm
Group No. FU 0547 - 1		
SLB	UCFL 217 - 53	
NTN	UCFL 217 - 305 D 1	

Figure MU 12 

Standard Duty
Flanged Units - Cast Housing
Eccentric Locking Collar Type, Set Screws Type

3.3465 in	ID	85.00 mm
6.8898 in	SB	175.00 mm
Group No. FU 0548 - 1		
SLB	UCF 217	
ASAHI	UCF 217	
FYH	UCF 217	
NACHI	UCF 217	
NSK	UCF 217	
NTN	UCF 217 D 1	

Figure MU 13 

Standard Duty
Flanged Cartridge Units - Cast Housing
Eccentric Locking Collar Type, Set Screws Type

3.3465 in	ID	85.00 mm
8.1890 in	SB	208.00 mm
Group No. FU 0549 - 1		
SLB	UCFC 217	
ASAHI	UCFC 217	
FYH	UCFC 217	
NACHI	UCFC 217	
NSK	UCFC 217	
NTN	UCFC 217 D 1	

Figure MU 15 

Standard Duty
Two Bolts Flanged Units - Cast Housing
Eccentric Locking Collar Type, Set Screws Type

3.3465 in	ID	85.00 mm
9.7638 in	SB	248.00 mm
Group No. FU 0550 - 1		
SLB	UCFL 217	
ASAHI	UCFL 217	
FYH	UCFL 217	
NACHI	UCFL 217	
NSK	ULFL 217	
NTN	UCFL 217 D 1	

Figure MU 12 

Standard Duty
Flanged Units - Cast Housing
Eccentric Locking Collar Type, Set Screws Type

3.4375 in	ID	87.31 mm
6.8898 in	SB	175.00 mm
Group No. FU 0551 - 1		
SLB	UCF 217 - 55	
NTN	UCF 217 - 307 D 1	

Figure MU 13 

Standard Duty
Flanged Cartridge Units - Cast Housing
Eccentric Locking Collar Type, Set Screws Type

3.4375 in	ID	87.31 mm
8.1890 in	SB	208.00 mm
Group No. FU 0552 - 1		
SLB	UCFC 217 - 55	
NTN	UCFC 217 - 307 D 1	

Figure MU 15 

Standard Duty
Two Bolts Flanged Units - Cast Housing
Eccentric Locking Collar Type, Set Screws Type

3.4375 in	ID	87.31 mm
9.7638 in	SB	248.00 mm
Group No. FU 0553 - 1		
SLB	UCFL 217 - 55	
NTN	UCFL 217 - 307 D 1	

Figure MU 12 

Standard Duty
Flanged Units - Cast Housing
Eccentric Locking Collar Type, Set Screws Type

3.3125 in	ID	84.14 mm
6.8898 in	SB	175.00 mm
Group No. FU 0545 - 1		
SLB	UCF 217 - 53	
NTN	UCF 217 - 305 D 1	

3.5000 in	ID	88.90 mm
7.3622 in	SB	187.00 mm
Group No. FU 0554 - 1		
SLB	UCF 218 - 56	
ASAHI	UCF 218 - 56	
FYH	UCF 218 - 56	
NACHI	UCF 218 - 56	
NSK	UCF 218 - 56 S	
NTN	UCF 218 - 308 D 1	
SKF	FY 3 - 1/2 TM	

FYH	UCF 218
INA	RCJY 90
NACHI	UCF 218
NSK	UCF 218
NTN	UCF 218 D 1
SKF	FY 90 TM

Figure MU 13 

Standard Duty
Flanged Cartridge Units - Cast Housing
Eccentric Locking Collar Type, Set Screws Type

3.5000 in	ID	88.90 mm
8.6614 in	SB	220.00 mm
Group No. FU 0555 - 1		
SLB	UCFC 218 - 56	
ASAHI	UCFC 218 - 56	
FYH	UCFC 218 - 56	
NACHI	UCFC 218 - 56	
NSK	UCFC 218 - 56 S	
NTN	UCFC 218 - 308 D 1	

Figure MU 13 

Standard Duty
Flanged Cartridge Units - Cast Housing
Eccentric Locking Collar Type, Set Screws Type

3.5433 in	ID	90.00 mm
8.6614 in	SB	220.00 mm
Group No. FU 0558 - 1		
SLB	UCFC 218	
ASAHI	UCFC 218	
FYH	UCFC 218	
INA	RMEY 90	
NACHI	UCFC 218	
NSK	UCFC 218	
NTN	UCFC 218 D 1	

Figure MU 15 

Standard Duty
Two Bolts Flanged Units - Cast Housing
Eccentric Locking Collar Type, Set Screws Type

3.5000 in	ID	88.90 mm
10.4331 in	SB	265.00 mm
Group No. FU 0556 - 1		
SLB	UCFL 218 - 56	
ASAHI	UCFL 218 - 56	
FYH	UCFL 218 - 56	
NACHI	UCFL 218 - 56	
NSK	ULFL 218 - 56 S	
NTN	UCFL 218 - 308 D 1	

Figure MU 15 

Standard Duty
Two Bolts Flanged Units - Cast Housing
Eccentric Locking Collar Type, Set Screws Type

3.5433 in	ID	90.00 mm
10.4331 in	SB	265.00 mm
Group No. FU 0559 - 1		
SLB	UCFL 218	
ASAHI	UCFL 218	
FYH	UCFL 218	
NACHI	UCFL 218	
NSK	ULFL 218	
NTN	UCFL 218 D 1	

Figure MU 12 

Standard Duty
Flanged Units - Cast Housing
Eccentric Locking Collar Type, Set Screws Type

3.5433 in	ID	90.00 mm
7.3622 in	SB	187.00 mm
Group No. FU 0557 - 1		
SLB	UCF 218	
ASAHI	UCF 218	

Figure MU 23

Standard Duty Cylindrical Cartridge Units
Eccentric Locking Collar Type, Set Screws Type

0.4724 in	ID	12.00 mm
2.8346 in	OD	72.00 mm
1.2205 in	W	31.00 mm

Group No. OT 0001 - 1

SLB	UCC 201
ASAHI	UCC 201
FYH	UCC 201
NACHI	UCC 201
NSK	UCC 201
NTN	UCC 201 D 1

Figure MU 23

Standard Duty Cylindrical Cartridge Units
Eccentric Locking Collar Type, Set Screws Type

0.5000 in	ID	12.70 mm
2.8346 in	OD	72.00 mm
1.2205 in	W	31.00 mm

Group No. OT 0002 - 1

SLB	UCC 201 - 8
ASAHI	UCC 201 - 8
FYH	UCC 201 - 8
NACHI	UCC 201 - 8
NSK	UCC 201 - 8 S
NTN	UCC 201 - 008 D 1

Figure MU 23

Standard Duty Cylindrical Cartridge Units
Eccentric Locking Collar Type, Set Screws Type

0.5625 in	ID	14.29 mm
2.8346 in	OD	72.00 mm
1.2205 in	W	31.00 mm

Group No. OT 0003 - 1

SLB	UCC 202 - 9
ASAHI	UCC 202 - 9
NACHI	UCC 202 - 9
NTN	UCC 202 - 009 D 1

Figure MU 23

Standard Duty Cylindrical Cartridge Units
Eccentric Locking Collar Type, Set Screws Type

0.5906 in	ID	15.00 mm
2.8346 in	OD	72.00 mm
1.2205 in	W	31.00 mm

Group No. OT 0004 - 1

SLB	UCC 202
ASAHI	UCC 202

FYH	UCC 202
NACHI	UCC 202
NSK	UCC 202
NTN	UCC 202 D 1

Figure MU 23

Standard Duty Cylindrical Cartridge Units
Eccentric Locking Collar Type, Set Screws Type

0.6250 in	ID	15.88 mm
2.8346 in	OD	72.00 mm
1.2205 in	W	31.00 mm

Group No. OT 0005 - 1

SLB	UCC 202 - 10
ASAHI	UCC 202 - 10
FYH	UCC 202 - 10
NACHI	UCC 202 - 10
NSK	UCC 202 - 10 S
NTN	UCC 202 - 010 D 1

Figure MU 23

Standard Duty Cylindrical Cartridge Units
Eccentric Locking Collar Type, Set Screws Type

0.6693 in	ID	17.00 mm
2.8346 in	OD	72.00 mm
1.2205 in	W	31.00 mm

Group No. OT 0006 - 1

SLB	UCC 203
ASAHI	UCC 203
FYH	UCC 203
NACHI	UCC 203
NSK	UCC 203
NTN	UCC 203 D 1

Figure MU 23

Standard Duty Cylindrical Cartridge Units
Eccentric Locking Collar Type, Set Screws Type

0.6875 in	ID	17.46 mm
2.8346 in	OD	72.00 mm
1.2205 in	W	31.00 mm

Group No. OT 0007 - 1

SLB	UCC 203 - 11
ASAHI	UCC 203 - 11
NACHI	UCC 203 - 11
NTN	UCC 203 - 011 D 1

Figure MU 23

Standard Duty Cylindrical Cartridge Units
Eccentric Locking Collar Type, Set Screws Type

0.7500 in	ID	19.05 mm
2.8346 in	OD	72.00 mm
1.2205 in	W	31.00 mm

Group No. OT 0008 - 1

SLB	UCC 204 - 12
ASAHI	UCC 204 - 12
FYH	UCC 204 - 12
NACHI	UCC 204 - 12
NSK	UCC 204 - 12 S
NTN	UCC 204 - 012 D 1

Figure MU 23

Standard Duty Cylindrical Cartridge Units
Eccentric Locking Collar Type, Set Screws Type

0.7874 in	ID	20.00 mm
2.8346 in	OD	72.00 mm
1.2205 in	W	31.00 mm

Group No. OT 0009 - 1

SLB	UCC 204
ASAHI	UCC 204
FYH	UCC 204
NACHI	UCC 204
NSK	UCC 204
NTN	UCC 204 D 1

Figure MU 27

Standard Duty Cylindrical Cartridge Units
Adapter Type

0.7874 in	ID	20.00 mm
3.1496 in	OD	80.00 mm
1.3386 in	W	34.00 mm

Group No. OT 0010 - 1

SLB	UKC 205
FYH	UKC 205
NACHI	UKC 205
NSK	UKC 205
NTN	UKC 205 D 1

Figure MU 23

Standard Duty Cylindrical Cartridge Units
Eccentric Locking Collar Type, Set Screws Type

0.8125 in	ID	20.64 mm
3.1496 in	OD	80.00 mm
1.3386 in	W	34.00 mm

Group No. OT 0011 - 1

SLB	UCC 205 - 13
NTN	UCC 205 - 013 D 1

Figure MU 23 

Standard Duty Cylindrical Cartridge Units
Eccentric Locking Collar Type, Set Screws Type

0.8750 in	ID	22.23 mm
3.1496 in	OD	80.00 mm
1.3386 in	W	34.00 mm

Group No. OT 0012 - 1

SLB	UCC 205 - 14
ASAHI	UCC 205 - 14
FYH	UCC 205 - 14
NACHI	UCC 205 - 14
NSK	UCC 205 - 14 S
NTN	UCC 205 - 014 D 1

Figure MU 23 

Standard Duty Cylindrical Cartridge Units
Eccentric Locking Collar Type, Set Screws Type

0.9375 in	ID	23.81 mm
3.1496 in	OD	80.00 mm
1.3386 in	W	34.00 mm

Group No. OT 0013 - 1

SLB	UCC 205 - 15
ASAHI	UCC 205 - 15
FYH	UCC 205 - 15
NACHI	UCC 205 - 15
NTN	UCC 205 - 015 D 1

Figure MU 23 

Standard Duty Cylindrical Cartridge Units
Eccentric Locking Collar Type, Set Screws Type

0.9843 in	ID	25.00 mm
3.1496 in	OD	80.00 mm
1.3386 in	W	34.00 mm

Group No. OT 0014 - 1

SLB	UCC 205
ASAHI	UCC 205
FYH	UCC 205
NACHI	UCC 205
NSK	UCC 205
NTN	UCC 205 D 1

Figure MU 27 

Standard Duty Cylindrical Cartridge Units
Adapter Type

0.9843 in	ID	25.00 mm
3.3465 in	OD	85.00 mm
1.5000 in	W	38.10 mm

Group No. OT 0015 - 1

SLB	UKC 206
FYH	UKC 206
NACHI	UKC 206
NSK	UKC 206
NTN	UKC 206 D 1

Figure MU 23 

Standard Duty Cylindrical Cartridge Units
Eccentric Locking Collar Type, Set Screws Type

1.0000 in	ID	25.40 mm
3.1496 in	OD	80.00 mm
1.3386 in	W	34.00 mm

Group No. OT 0016 - 1

SLB	UCC 205 - 16
ASAHI	UCC 205 - 16
FYH	UCC 205 - 16
NACHI	UCC 205 - 16
NSK	UCC 205 - 16 S
NTN	UCC 205 - 100 D 1

Figure MU 23 

Standard Duty Cylindrical Cartridge Units
Eccentric Locking Collar Type, Set Screws Type

1.0625 in	ID	26.99 mm
3.3465 in	OD	85.00 mm
1.5000 in	W	38.10 mm

Group No. OT 0017 - 1

SLB	UCC 206 - 17
ASAHI	UCC 206 - 17
NACHI	UCC 206 - 17
NTN	UCC 206 - 101 D 1

Figure MU 23 

Standard Duty Cylindrical Cartridge Units
Eccentric Locking Collar Type, Set Screws Type

1.1250 in	ID	28.58 mm
3.3465 in	OD	85.00 mm
1.5000 in	W	38.10 mm

Group No. OT 0018 - 1

SLB	UCC 206 - 18
ASAHI	UCC 206 - 18
FYH	UCC 206 - 18
NACHI	UCC 206 - 18
NSK	UCC 206 - 18 S
NTN	UCC 206 - 102 D 1

Figure MU 23 

Standard Duty Cylindrical Cartridge Units
Eccentric Locking Collar Type, Set Screws Type

1.1811 in	ID	30.00 mm
3.3465 in	OD	85.00 mm
1.5000 in	W	38.10 mm

Group No. OT 0019 - 1

SLB	UCC 206
ASAHI	UCC 206
FYH	UCC 206
NACHI	UCC 206
NSK	UCC 206
NTN	UCC 206 D 1

Figure MU 27 

Standard Duty Cylindrical Cartridge Units
Adapter Type

1.1811 in	ID	30.00 mm
3.5433 in	OD	90.00 mm
1.6890 in	W	42.90 mm

Group No. OT 0020 - 1

SLB	UKC 207
FYH	UKC 207
NACHI	UKC 207
NSK	UKC 207
NTN	UKC 207 D 1

Figure MU 23 

Standard Duty Cylindrical Cartridge Units
Eccentric Locking Collar Type, Set Screws Type

1.1875 in	ID	30.16 mm
3.3465 in	OD	85.00 mm
1.5000 in	W	38.10 mm

Group No. OT 0021 - 1

SLB	UCC 206 - 19
ASAHI	UCC 206 - 19
FYH	UCC 206 - 19
NACHI	UCC 206 - 19
NTN	UCC 206 - 103 D 1

Figure MU 23 

Standard Duty Cylindrical Cartridge Units
Eccentric Locking Collar Type, Set Screws Type

1.2500 in	ID	31.75 mm
3.3465 in	OD	85.00 mm
1.5000 in	W	38.10 mm

Group No. OT 0022 - 1

SLB	UCC 206 - 20
NTN	UCC 206 - 104 D 1

Figure MU 23 

Standard Duty Cylindrical Cartridge Units
Eccentric Locking Collar Type, Set Screws Type

1.2500 in	ID	31.75 mm
3.5433 in	OD	90.00 mm
1.6890 in	W	42.90 mm

Group No. OT 0023 - 1

SLB	UCC 207 - 20
ASAHI	UCC 207 - 20
FYH	UCC 207 - 20
NACHI	UCC 207 - 20
NSK	UCC 207 - 20 S
NTN	UCC 207 - 104 D 1

Figure MU 23

Standard Duty Cylindrical Cartridge Units
Eccentric Locking Collar Type, Set Screws Type

1.3125 in	ID	33.34 mm
3.5433 in	OD	90.00 mm
1.6890 in	W	42.90 mm

Group No. OT 0024 - 1

SLB	UCC 207 - 21
ASAHI	UCC 207 - 21
FYH	UCC 207 - 21
NACHI	UCC 207 - 21
NTN	UCC 207 - 105 D 1

Figure MU 23

Standard Duty Cylindrical Cartridge Units
Eccentric Locking Collar Type, Set Screws Type

1.3750 in	ID	34.93 mm
3.5433 in	OD	90.00 mm
1.6890 in	W	42.90 mm

Group No. OT 0025 - 1

SLB	UCC 207 - 22
ASAHI	UCC 207 - 22
FYH	UCC 207 - 22
NACHI	UCC 207 - 22
NSK	UCC 207 - 22 S
NTN	UCC 207 - 106 D 1

Figure MU 23

Standard Duty Cylindrical Cartridge Units
Eccentric Locking Collar Type, Set Screws Type

1.3780 in	ID	35.00 mm
3.5433 in	OD	90.00 mm
1.6890 in	W	42.90 mm

Group No. OT 0026 - 1

SLB	UCC 207
ASAHI	UCC 207
FYH	UCC 207
NACHI	UCC 207
NSK	UCC 207
NTN	UCC 207 D 1

Figure MU 27

Standard Duty Cylindrical Cartridge Units
Adapter Type

1.3780 in	ID	35.00 mm
3.9370 in	OD	100.00 mm
1.9370 in	W	49.20 mm

Group No. OT 0027 - 1

SLB	UKC 208
FYH	UKC 208
NACHI	UKC 208
NSK	UKC 208
NTN	UKC 208 D 1

Figure MU 23

Standard Duty Cylindrical Cartridge Units
Eccentric Locking Collar Type, Set Screws Type

1.4375 in	ID	36.51 mm
3.5433 in	OD	90.00 mm
1.6890 in	W	42.90 mm

Group No. OT 0028 - 1

SLB	UCC 207 - 23
ASAHI	UCC 207 - 23
FYH	UCC 207 - 23
NACHI	UCC 207 - 23
NTN	UCC 207 - 107 D 1

Figure MU 23

Standard Duty Cylindrical Cartridge Units
Eccentric Locking Collar Type, Set Screws Type

1.5000 in	ID	38.10 mm
3.9370 in	OD	100.00 mm
1.9370 in	W	49.20 mm

Group No. OT 0029 - 1

SLB	UCC 208 - 24
ASAHI	UCC 208 - 24
FYH	UCC 208 - 24
NACHI	UCC 208 - 24
NSK	UCC 208 - 24 S
NTN	UCC 208 - 108 D 1

Figure MU 23

Standard Duty Cylindrical Cartridge Units
Eccentric Locking Collar Type, Set Screws Type

1.5625 in	ID	39.69 mm
3.9370 in	OD	100.00 mm
1.9370 in	W	49.20 mm

Group No. OT 0030 - 1

SLB	UCC 208 - 25
ASAHI	UCC 208 - 25

FYH	UCC 208 - 25
NACHI	UCC 208 - 25
NTN	UCC 208 - 109 D 1

Figure MU 27

Standard Duty Cylindrical Cartridge Units
Adapter Type

1.5748 in	ID	40.00 mm
4.3307 in	OD	110.00 mm
1.9370 in	W	49.20 mm

Group No. OT 0031 - 1

SLB	UKC 209
FYH	UKC 209
NACHI	UKC 209
NSK	UKC 209
NTN	UKC 209 D 1

Figure MU 23

Standard Duty Cylindrical Cartridge Units
Eccentric Locking Collar Type, Set Screws Type

1.5748 in	ID	40.00 mm
3.9370 in	OD	100.00 mm
1.9370 in	W	49.20 mm

Group No. OT 0032 - 1

SLB	UCC 208
ASAHI	UCC 208
FYH	UCC 208
NACHI	UCC 208
NSK	UCC 208
NTN	UCC 208 D 1

Figure MU 23

Standard Duty Cylindrical Cartridge Units
Eccentric Locking Collar Type, Set Screws Type

1.6250 in	ID	41.28 mm
4.3307 in	OD	110.00 mm
1.9370 in	W	49.20 mm

Group No. OT 0033 - 1

SLB	UCC 209 - 26
ASAHI	UCC 209 - 26
FYH	UCC 209 - 26
NACHI	UCC 209 - 26
NSK	UCC 209 - 26 S
NTN	UCC 209 - 110 D 1

Figure MU 23

Standard Duty Cylindrical Cartridge Units
Eccentric Locking Collar Type, Set Screws Type

1.6875 in	ID	42.86 mm
4.3307 in	OD	110.00 mm
1.9370 in	W	49.20 mm

Group No. OT 0034 - 1

SLB	UCC 209 - 27
ASAHI	UCC 209 - 27
FYH	UCC 209 - 27
NACHI	UCC 209 - 27
NTN	UCC 209 - 111 D 1

Figure MU 23

Standard Duty Cylindrical Cartridge Units
Eccentric Locking Collar Type, Set Screws Type

1.8125 in	ID	46.04 mm
4.7244 in	OD	120.00 mm
2.0315 in	W	51.60 mm

Group No. OT 0038 - 1

SLB	UCC 210 - 29
NTN	UCC 210 - 113 D 1

Figure MU 27

Standard Duty Cylindrical Cartridge Units
Adapter Type

1.9685 in	ID	50.00 mm
4.9213 in	OD	125.00 mm
2.1890 in	W	55.60 mm

Group No. OT 0042 - 1

SLB	UKC 211
FYH	UKC 211
NACHI	UKC 211
NSK	UKC 211
NTN	UKC 211 D 1

Figure MU 23

Standard Duty Cylindrical Cartridge Units
Eccentric Locking Collar Type, Set Screws Type

1.7500 in	ID	44.45 mm
4.3307 in	OD	110.00 mm
1.9370 in	W	49.20 mm

Group No. OT 0035 - 1

SLB	UCC 209 - 28
ASAHI	UCC 209 - 28
FYH	UCC 209 - 28
NACHI	UCC 209 - 28
NSK	UCC 209 - 28 S
NTN	UCC 209 - 112 D 1

Figure MU 23

Standard Duty Cylindrical Cartridge Units
Eccentric Locking Collar Type, Set Screws Type

1.8750 in	ID	47.63 mm
4.7244 in	OD	120.00 mm
2.0315 in	W	51.60 mm

Group No. OT 0039 - 1

SLB	UCC 210 - 30
ASAHI	UCC 210 - 30
FYH	UCC 210 - 30
NACHI	UCC 210 - 30
NSK	UCC 210 - 30 S
NTN	UCC 210 - 114 D 1

Figure MU 23

Standard Duty Cylindrical Cartridge Units
Eccentric Locking Collar Type, Set Screws Type

2.0000 in	ID	50.80 mm
4.7244 in	OD	120.00 mm
2.0315 in	W	51.60 mm

Group No. OT 0043 - 1

SLB	UCC 210 - 32
NTN	UCC 210 - 200 D 1

Figure MU 23

Standard Duty Cylindrical Cartridge Units
Eccentric Locking Collar Type, Set Screws Type

1.7717 in	ID	45.00 mm
4.3307 in	OD	110.00 mm
1.9370 in	W	49.20 mm

Group No. OT 0036 - 1

SLB	UCC 209
ASAHI	UCC 209
FYH	UCC 209
NACHI	UCC 209
NSK	UCC 209
NTN	UCC 209 D 1

Figure MU 23

Standard Duty Cylindrical Cartridge Units
Eccentric Locking Collar Type, Set Screws Type

1.9375 in	ID	49.21 mm
4.7244 in	OD	120.00 mm
2.0315 in	W	51.60 mm

Group No. OT 0040 - 1

SLB	UCC 210 - 31
ASAHI	UCC 210 - 31
FYH	UCC 210 - 31
NACHI	UCC 210 - 31
NTN	UCC 210 - 115 D 1

Figure MU 23

Standard Duty Cylindrical Cartridge Units
Eccentric Locking Collar Type, Set Screws Type

2.0000 in	ID	50.80 mm
4.9213 in	OD	125.00 mm
2.1890 in	W	55.60 mm

Group No. OT 0044 - 1

SLB	UCC 211 - 32
ASAHI	UCC 211 - 32
FYH	UCC 211 - 32
NACHI	UCC 211 - 32
NSK	UCC 211 - 32 S
NTN	UCC 211 - 200 D 1

Figure MU 27

Standard Duty Cylindrical Cartridge Units
Adapter Type

1.7717 in	ID	45.00 mm
4.7244 in	OD	120.00 mm
2.0315 in	W	51.60 mm

Group No. OT 0037 - 1

SLB	UKC 210
FYH	UKC 210
NACHI	UKC 210
NSK	UKC 210
NTN	UKC 210 D 1

Figure MU 23

Standard Duty Cylindrical Cartridge Units
Eccentric Locking Collar Type, Set Screws Type

1.9685 in	ID	50.00 mm
4.7244 in	OD	120.00 mm
2.0315 in	W	51.60 mm

Group No. OT 0041 - 1

SLB	UCC 210
ASAHI	UCC 210
FYH	UCC 210
NACHI	UCC 210
NSK	UCC 210
NTN	UCC 210 D 1

Figure MU 23

Standard Duty Cylindrical Cartridge Units
Eccentric Locking Collar Type, Set Screws Type

2.0625 in	ID	52.39 mm
4.9213 in	OD	125.00 mm
2.1890 in	W	55.60 mm

Group No. OT 0045 - 1

SLB	UCC 211 - 33
ASAHI	UCC 211 - 33
NACHI	UCC 211 - 33
NTN	UCC 211 - 201 D 1

Figure MU 23

Standard Duty Cylindrical Cartridge Units
Eccentric Locking Collar Type, Set Screws Type

2.1250 in	ID	53.98 mm
4.9213 in	OD	125.00 mm
2.1890 in	W	55.60 mm

Group No. OT 0046 - 1

SLB	UCC 211 - 34
ASAHI	UCC 211 - 34
FYH	UCC 211 - 34
NACHI	UCC 211 - 34
NSK	UCC 211 - 34 S
NTN	UCC 211 - 202 D 1

Figure MU 23

Standard Duty Cylindrical Cartridge Units
Eccentric Locking Collar Type, Set Screws Type

2.1654 in	ID	55.00 mm
4.9213 in	OD	125.00 mm
2.1890 in	W	55.60 mm

Group No. OT 0047 - 1

SLB	UCC 211
ASAHI	UCC 211
FYH	UCC 211
NACHI	UCC 211
NSK	UCC 211
NTN	UCC 211 D 1

Figure MU 27

Standard Duty Cylindrical Cartridge Units
Adapter Type

2.1654 in	ID	55.00 mm
5.1181 in	OD	130.00 mm
2.5630 in	W	65.10 mm

Group No. OT 0048 - 1

SLB	UKC 212
FYH	UKC 212
NACHI	UKC 212
NSK	UKC 212
NTN	UKC 212 D 1

Figure MU 23

Standard Duty Cylindrical Cartridge Units
Eccentric Locking Collar Type, Set Screws Type

2.1875 in	ID	55.56 mm
4.9213 in	OD	125.00 mm
2.1890 in	W	55.60 mm

Group No. OT 0049 - 1

SLB	UCC 211 - 35
ASAHI	UCC 211 - 35

FYH	UCC 211 - 35
NACHI	UCC 211 - 35
NTN	UCC 211 - 203 D 1

Figure MU 23

Standard Duty Cylindrical Cartridge Units
Eccentric Locking Collar Type, Set Screws Type

2.2500 in	ID	57.15 mm
5.1181 in	OD	130.00 mm
2.5630 in	W	65.10 mm

Group No. OT 0050 - 1

SLB	UCC 212 - 36
ASAHI	UCC 212 - 36
FYH	UCC 212 - 36
NACHI	UCC 212 - 36
NSK	UCC 212 - 36 S
NTN	UCC 212 - 204 D 1

Figure MU 23

Standard Duty Cylindrical Cartridge Units
Eccentric Locking Collar Type, Set Screws Type

2.3125 in	ID	58.74 mm
5.1181 in	OD	130.00 mm
2.5630 in	W	65.10 mm

Group No. OT 0051 - 1

SLB	UCC 212 - 37
NTN	UCC 212 - 205 D 1

Figure MU 23

Standard Duty Cylindrical Cartridge Units
Eccentric Locking Collar Type, Set Screws Type

2.3622 in	ID	60.00 mm
5.1181 in	OD	130.00 mm
2.5630 in	W	65.10 mm

Group No. OT 0052 - 1

SLB	UCC 212
ASAHI	UCC 212
FYH	UCC 212
NACHI	UCC 212
NSK	UCC 212
NTN	UCC 212 D 1

Figure MU 27

Standard Duty Cylindrical Cartridge Units
Adapter Type

2.3622 in	ID	60.00 mm
5.1181 in	OD	140.00 mm
2.5630 in	W	65.10 mm

Group No. OT 0053 - 1

SLB	UKC 213
FYH	UKC 213
NACHI	UKC 213
NSK	UKC 213
NTN	UKC 213 D 1

Figure MU 23

Standard Duty Cylindrical Cartridge Units
Eccentric Locking Collar Type, Set Screws Type

2.3750 in	ID	60.33 mm
5.1181 in	OD	130.00 mm
2.5630 in	W	65.10 mm

Group No. OT 0054 - 1

SLB	UCC 212 - 38
ASAHI	UCC 212 - 38
FYH	UCC 212 - 38
NACHI	UCC 212 - 38
NSK	UCC 212 - 38 S
NTN	UCC 212 - 206 D 1

Figure MU 23

Standard Duty Cylindrical Cartridge Units
Eccentric Locking Collar Type, Set Screws Type

2.4375 in	ID	61.91 mm
5.1181 in	OD	130.00 mm
2.5630 in	W	65.10 mm

Group No. OT 0055 - 1

SLB	UCC 212 - 39
ASAHI	UCC 212 - 39
FYH	UCC 212 - 39
NACHI	UCC 212 - 39
NTN	UCC 212 - 207 D 1

Figure MU 23

Standard Duty Cylindrical Cartridge Units
Eccentric Locking Collar Type, Set Screws Type

2.5000 in	ID	63.50 mm
5.5118 in	OD	140.00 mm
2.5630 in	W	65.10 mm

Group No. OT 0056 - 1

SLB	UCC 213 - 40
ASAHI	UCC 213 - 40
FYH	UCC 213 - 40
NACHI	UCC 213 - 40
NSK	UCC 213 - 40 S
NTN	UCC 213 - 208 D 1

Figure MU 23

Standard Duty Cylindrical Cartridge Units
Eccentric Locking Collar Type, Set Screws Type

2.5591 in	ID	65.00 mm
5.5118 in	OD	140.00 mm
2.5630 in	W	65.10 mm

Group No. OT 0057 - 1

SLB	UCC 213
ASAHI	UCC 213
FYH	UCC 213
NACHI	UCC 213
NSK	UCC 213
NTN	UCC 213 D 1

Figure MU 23

Standard Duty Cylindrical Cartridge Units
Eccentric Locking Collar Type, Set Screws Type

2.5625 in	ID	65.09 mm
5.5118 in	OD	140.00 mm
2.5630 in	W	65.10 mm

Group No. OT 0058 - 1

SLB	UCC 213 - 41
NTN	UCC 213 - 209 D 1

Figure MU 24

Standard Duty Hanger Units
Eccentric Locking Collar Type, Set Screws Type

0.4724 in	ID	12.00 mm
2.5197 in	SE	64.00 mm
Rp 3/4	PS	

Group No. OT 0059 - 1

SLB	UCHA 201
FYH	UCHA 201
NSK	UCEH 201
NTN	UCHB 201 D 1

Figure MU 24

Standard Duty Hanger Units
Eccentric Locking Collar Type, Set Screws Type

0.5000 in	ID	12.70 mm
2.5197 in	SE	64.00 mm
Rp 3/4	PS	

Group No. OT 0060 - 1

SLB	UCHA 201 - 8
FYH	UCHA 201 - 8
NSK	UCEH 201 - 8 S
NTN	UCHB 201 - 008 D 1

Figure MU 24

Standard Duty Hanger Units
Eccentric Locking Collar Type, Set Screws Type

0.5625 in	ID	14.29 mm
2.5197 in	SE	64.00 mm
Rp 3/4	PS	

Group No. OT 0061 - 1

SLB	UCHA 202 - 9
NTN	UCHB 202 - 009 D 1

Figure MU 24

Standard Duty Hanger Units
Eccentric Locking Collar Type, Set Screws Type

0.5906 in	ID	15.00 mm
2.5197 in	SE	64.00 mm
Rp 3/4	PS	

Group No. OT 0062 - 1

SLB	UCHA 202
FYH	UCHA 202
NSK	UCEH 202
NTN	UCHB 202 D 1

Figure MU 24

Standard Duty Hanger Units
Eccentric Locking Collar Type, Set Screws Type

0.6250 in	ID	15.88 mm
2.5197 in	SE	64.00 mm
Rp 3/4	PS	

Group No. OT 0063 - 1

SLB	UCHA 202 - 10
FYH	UCHA 202 - 10
NSK	UCEH 202 - 10 S
NTN	UCHB 202 - 010 D 1

Figure MU 24

Standard Duty Hanger Units
Eccentric Locking Collar Type, Set Screws Type

0.6693 in	ID	17.00 mm
2.5197 in	SE	64.00 mm
Rp 3/4	PS	

Group No. OT 0064 - 1

SLB	UCHA 203
FYH	UCHA 203
NSK	UCEH 203
NTN	UCHB 203 D 1

Figure MU 24

Standard Duty Hanger Units
Eccentric Locking Collar Type, Set Screws Type

0.6875 in	ID	17.46 mm
2.5197 in	SE	64.00 mm
Rp 3/4	PS	

Group No. OT 0065 - 1

SLB	UCHA 203 - 11
NTN	UCHB 203 - 011 D 1

Figure MU 24

Standard Duty Hanger Units
Eccentric Locking Collar Type, Set Screws Type

0.7500 in	ID	19.05 mm
2.5197 in	SE	64.00 mm
Rp 3/4	PS	

Group No. OT 0066 - 1

SLB	UCHA 204 - 12
FYH	UCHA 204 - 12
INA	RHEY 3/4"
NSK	UCEH 204 - 12 S
NTN	UCHB 204 - 012 D 1

Group No. OT 0066 - 2

SLB	SAHA 204 - 12
INA	PHE 3/4"

Figure MU 24

Standard Duty Hanger Units
Eccentric Locking Collar Type, Set Screws Type

0.7874 in	ID	20.00 mm
2.5197 in	SE	64.00 mm
Rp 3/4	PS	

Group No. OT 0067 - 1

SLB	UCHA 204
FYH	UCHA 204
NSK	UCEH 204
NTN	UCHB 204 D 1

Group No. OT 0067 - 2

SLB	SAHA 204
INA	PHE 20

Figure MU 24

Standard Duty Hanger Units
Eccentric Locking Collar Type, Set Screws Type

0.8125 in	ID	20.64 mm
2.5197 in	SE	64.00 mm
Rp 3/4	PS	

Group No. OT 0068 - 1

SLB	UCHA 205 - 13
NTN	UCHB 205 - 013 D 1

Figure MU 24

Standard Duty Hanger Units
Eccentric Locking Collar Type, Set Screws Type

0.8750 in	ID	22.23 mm
2.5197 in	SE	64.00 mm
Rp 3/4	PS	

Group No. OT 0069 - 1

SLB	UCHA 205 - 14
ASAHI	UCECH 205 - 14
FYH	UCHA 205 - 14
INA	RHEY 7/8"
NACHI	UCECH 205 - 14
NSK	UCEH 205 - 14 S
NTN	UCHB 205 - 014 D 1

Group No. OT 0069 - 2

SLB	SAHA 205 - 14
INA	PHE 7/8"

Figure MU 24

Standard Duty Hanger Units
Eccentric Locking Collar Type, Set Screws Type

0.9375 in	ID	23.81 mm
2.5197 in	SE	64.00 mm
Rp 3/4	PS	

Group No. OT 0070 - 1

SLB	UCHA 205 - 15
ASAHI	UCECH 205 - 15
FYH	UCHA 205 - 15
NACHI	UCECH 205 - 15
NTN	UCHB 205 - 015 D 1

Figure MU 24

Standard Duty Hanger Units
Eccentric Locking Collar Type, Set Screws Type

0.9843 in	ID	25.00 mm
2.5197 in	SE	64.00 mm
Rp 3/4	PS	

Group No. OT 0071 - 1

SLB	UCHA 205
ASAHI	UCECH 205
FYH	UCHA 205
NACHI	UCECH 205
NSK	UCEH 205
NTN	UCHB 205 D 1

Group No. OT 0071 - 2

SLB	SAHA 205
INA	PHE 25

Figure MU 24

Standard Duty Hanger Units
Eccentric Locking Collar Type, Set Screws Type

1.0000 in	ID	25.40 mm
2.5197 in	SE	64.00 mm
Rp 3/4	PS	

Group No. OT 0072 - 1

SLB	UCHA 205 - 16
ASAHI	UCECH 205 - 16
FYH	UCHA 205 - 16
INA	RHEY 1"
NACHI	UCECH 205 - 16
NSK	UCEH 205 - 16 S
NTN	UCHB 205 - 100 D 1

Group No. OT 0072 - 2

SLB	SAHA 205 - 16
INA	PHE 1"

Figure MU 24

Standard Duty Hanger Units
Eccentric Locking Collar Type, Set Screws Type

1.0625 in	ID	26.99 mm
2.5197 in	SE	64.00 mm
Rp 3/4	PS	

Group No. OT 0073 - 1

SLB	UCHA 206 - 17
ASAHI	UCECH 206 - 17
NACHI	UCECH 206 - 17
NTN	UCHB 206 - 101 D 1

Group No. OT 0073 - 2

SLB	SAHA 206 - 17
INA	PHE 1 1/16"

Figure MU 24

Standard Duty Hanger Units
Eccentric Locking Collar Type, Set Screws Type

1.1250 in	ID	28.58 mm
2.5197 in	SE	64.00 mm
Rp 3/4	PS	

Group No. OT 0074 - 1

SLB	UCHA 206 - 18
ASAHI	UCECH 206 - 18
FYH	UCHA 206 - 18
INA	RHEY 1 1/8"
NACHI	UCECH 206 - 18
NSK	UCEH 206 - 18 S
NTN	UCHB 206 - 102 D 1
SEALMASTER	SEHB - 18

Group No. OT 0074 - 2

SLB	SAHA 206 - 18
INA	PHE 1 1/8"

Figure MU 24

Standard Duty Hanger Units
Eccentric Locking Collar Type, Set Screws Type

1.1811 in	ID	30.00 mm
2.5197 in	SE	64.00 mm
Rp 3/4	PS	

Group No. OT 0075 - 1

SLB	UCHA 206
ASAHI	UCECH 206
FYH	UCHA 206
NACHI	UCECH 206
NSK	UCEH 206
NTN	UCHB 206 D 1
SEALMASTER	SEHB - 206

Group No. OT 0075 - 2

SLB	SAHA 206
INA	PHE 30

Figure MU 24

Standard Duty Hanger Units
Eccentric Locking Collar Type, Set Screws Type

1.1875 in	ID	30.16 mm
2.5197 in	SE	64.00 mm
Rp 3/4	PS	

Group No. OT 0076 - 1

SLB	UCHA 206 - 19
ASAHI	UCECH 206 - 19
FYH	UCHA 206 - 19
NACHI	UCECH 206 - 19
NTN	UCHB 206 - 103 D 1

Group No. OT 0076 - 2

SLB	SAHA 206 - 19
INA	PHE 1 3/16"

Figure MU 24

Standard Duty Hanger Units
Eccentric Locking Collar Type, Set Screws Type

1.2500 in	ID	31.75 mm
2.5197 in	SE	64.00 mm
Rp 3/4	PS	

Group No. OT 0077 - 1

SLB	UCHA 206 - 20
INA	RHEY 1 1/4" - 206
NTN	UCHB 206 - 104 D 1

Group No. OT 0077 - 2

SLB	SAHA 206 - 20
INA	PHE 1 1/4" - 206

Figure MU 24

Standard Duty Hanger Units
Eccentric Locking Collar Type, Set Screws Type

1.2500 in	ID	31.75 mm
2.7559 in	SE	70.00 mm
Rp 3/4	PS	

Group No. OT 0078 - 1

SLB	UCHA 207 - 20
ASAHI	UCECH 207 - 20
FYH	UCHA 207 - 20
INA	RHEY 1 1/4"
NACHI	UCECH 207 - 20
NSK	UCEH 207 - 20 S
NTN	UCHB 207 - 104 D 1
SEALMASTER	SEHB - 20

Group No. OT 0078 - 2

SLB	SAHA 207 - 20
INA	PHE 1 1/4"

Figure MU 24
Standard Duty Hanger Units
Eccentric Locking Collar Type, Set Screws Type

1.3125 in	ID	33.34 mm
2.7559 in	SE	70.00 mm
Rp 3/4	PS	

Group No. OT 0079 - 1

SLB	UCHA 207 - 21
ASAHI	UCECH 207 - 21
FYH	UCHA 207 - 21
NACHI	UCECH 207 - 21
NTN	UCHB 207 - 105 D 1
SEALMASTER	SEHB - 21

Figure MU 24
Standard Duty Hanger Units
Eccentric Locking Collar Type, Set Screws Type

1.3750 in	ID	34.93 mm
2.7559 in	SE	70.00 mm
Rp 3/4	PS	

Group No. OT 0080 - 1

SLB	UCHA 207 - 22
ASAHI	UCECH 207 - 22
FYH	UCHA 207 - 22
INA	RHEY 1 3/8"
NACHI	UCECH 207 - 22
NSK	UCEH 207 - 22 S
NTN	UCHB 207 - 106 D 1
SEALMASTER	SEHB - 22

Group No. OT 0080 - 2

SLB	SAHA 207 - 22
INA	PHE 1 3/8"

Figure MU 24
Standard Duty Hanger Units
Eccentric Locking Collar Type, Set Screws Type

1.3780 in	ID	35.00 mm
2.7559 in	SE	70.00 mm
Rp 3/4	PS	

Group No. OT 0081 - 1

SLB	UCHA 207
ASAHI	UCECH 207
FYH	UCHA 207
NACHI	UCECH 207
NSK	UCEH 207
NTN	UCHB 207 D 1
SEALMASTER	SEHB - 207

Group No. OT 0081 - 2

SLB	SAHA 207
INA	PHE 35

Figure MU 24
Standard Duty Hanger Units
Eccentric Locking Collar Type, Set Screws Type

1.4375 in	ID	36.51 mm
2.7559 in	SE	70.00 mm
Rp 3/4	PS	

Group No. OT 0082 - 1

SLB	UCHA 207 - 23
ASAHI	UCECH 207 - 23
FYH	UCHA 207 - 23
NACHI	UCECH 207 - 23
NTN	UCHB 207 - 107 D 1

Group No. OT 0082 - 2

SLB	SAHA 207 - 23
INA	PHE 1 7/16"

Figure MU 24
Standard Duty Hanger Units
Eccentric Locking Collar Type, Set Screws Type

1.5000 in	ID	38.10 mm
2.8740 in	SE	73.00 mm
Rp 3/4	PS	

Group No. OT 0083 - 1

SLB	UCHA 208 - 24
ASAHI	UCECH 208 - 24
FYH	UCHA 208 - 24
INA	RHEY 1 1/2"
NACHI	UCECH 208 - 24
NSK	UCEH 208 - 24 S
NTN	UCHB 208 - 108 D 1
SEALMASTER	SEHB - 24

Group No. OT 0083 - 2
SLB SAHA 208 - 24
INA PHE 1 1/2"

Figure MU 24
Standard Duty Hanger Units
Eccentric Locking Collar Type, Set Screws Type

1.5625 in	ID	39.69 mm
2.8740 in	SE	73.00 mm
Rp 3/4	PS	

Group No. OT 0084 - 1

SLB	UCHA 208 - 25
ASAHI	UCECH 208 - 25
FYH	UCHA 208 - 25
NACHI	UCECH 208 - 25
NTN	UCHB 208 - 109 D 1
SEALMASTER	SEHB - 25

Figure MU 24
Standard Duty Hanger Units
Eccentric Locking Collar Type, Set Screws Type

1.5748 in	ID	40.00 mm
2.8740 in	SE	73.00 mm
Rp 3/4	PS	

Group No. OT 0085 - 1

SLB	UCHA 208
ASAHI	UCECH 208
FYH	UCHA 208
NACHI	UCECH 208
NSK	UCEH 208
NTN	UCHB 208 D 1
SEALMASTER	SEHB - 208

Group No. OT 0085 - 2

SLB	SAHA 208
INA	PHE 40

Figure MU 24
Standard Duty Hanger Units
Eccentric Locking Collar Type, Set Screws Type

1.6250 in	ID	41.28 mm
3.2283 in	SE	82.00 mm
Rp 1	PS	

Group No. OT 0086 - 1

SLB	UCHA 209 - 26
ASAHI	UCECH 209 - 26
FYH	UCHA 209 - 26
NACHI	UCECH 209 - 26
NSK	UCEH 209 - 26 S
NTN	UCHB 209 - 110 D 1

Figure MU 24

Standard Duty Hanger Units

Eccentric Locking Collar Type, Set Screws Type

1.6875 in	ID	42.86 mm
3.2283 in	SE	82.00 mm
Rp 1	PS	

Group No. OT 0087 - 1

SLB	UCHA 209 - 27
ASAHI	UCECH 209 - 27
FYH	UCHA 209 - 27
NACHI	UCECH 209 - 27
NTN	UCHB 209 - 111 D 1

Figure MU 24

Standard Duty Hanger Units

Eccentric Locking Collar Type, Set Screws Type

1.7500 in	ID	44.45 mm
3.2283 in	SE	82.00 mm
Rp 1	PS	

Group No. OT 0088 - 1

SLB	UCHA 209 - 28
ASAHI	UCECH 209 - 28
FYH	UCHA 209 - 28
INA	RHEY 1 3/4"
NACHI	UCECH 209 - 28
NSK	UCEH 209 - 28 S
NTN	UCHB 209 - 112 D 1

Group No. OT 0088 - 2

SLB	SAHA 209 - 28
INA	PHE 1 3/4"

Figure MU 24

Standard Duty Hanger Units

Eccentric Locking Collar Type, Set Screws Type

1.7717 in	ID	45.00 mm
3.2283 in	SE	82.00 mm
Rp 1	PS	

Group No. OT 0089 - 1

SLB	UCHA 209
ASAHI	UCECH 209
FYH	UCHA 209
NACHI	UCECH 209
NSK	UCEH 209
NTN	UCHB 209 D 1

Group No. OT 0089 - 2

SLB	SAHA 209
INA	PHE 45

Figure MU 24

Standard Duty Hanger Units

Eccentric Locking Collar Type, Set Screws Type

1.8125 in	ID	46.04 mm
3.2677 in	SE	83.00 mm
Rp 1	PS	

Group No. OT 0090 - 1

SLB	UCHA 210 - 29
NTN	UCHB 210 - 113 D 1

Figure MU 24

Standard Duty Hanger Units

Eccentric Locking Collar Type, Set Screws Type

1.8750 in	ID	47.63 mm
3.2677 in	SE	83.00 mm
Rp 1	PS	

Group No. OT 0091 - 1

SLB	UCHA 210 - 30
ASAHI	UCECH 210 - 30
FYH	UCHA 210 - 30
NACHI	UCECH 210 - 30
NSK	UCEH 210 - 30 S
NTN	UCHB 210 - 114 D 1

Figure MU 24

Standard Duty Hanger Units

Eccentric Locking Collar Type, Set Screws Type

1.9375 in	ID	49.21 mm
3.2677 in	SE	83.00 mm
Rp 1	PS	

Group No. OT 0092 - 1

SLB	UCHA 210 - 31
ASAHI	UCECH 210 - 31
FYH	UCHA 210 - 31
INA	RHEY 1 15/16"
NACHI	UCECH 210 - 31
NTN	UCHB 210 - 115 D 1

Group No. OT 0092 - 2

SLB	SAHA 210 - 31
INA	PHE 1 15/16"

Figure MU 24

Standard Duty Hanger Units

Eccentric Locking Collar Type, Set Screws Type

1.9685 in	ID	50.00 mm
3.2677 in	SE	83.00 mm
Rp 1	PS	

Group No. OT 0093 - 1

SLB	UCHA 210
ASAHI	UCECH 210
FYH	UCHA 210
NACHI	UCECH 210
NSK	UCEH 210
NTN	UCHB 210 D 1

Group No. OT 0093 - 2

SLB	SAHA 210
INA	PHE 50

Figure MU 24

Standard Duty Hanger Units

Eccentric Locking Collar Type, Set Screws Type

2.0000 in	ID	50.80 mm
3.2677 in	SE	83.00 mm
Rp 1	PS	

Group No. OT 0094 - 1

SLB	UCHA 210 - 32
NTN	UCHB 210 - 200 D 1

Figure MU 24

Standard Duty Hanger Units

Eccentric Locking Collar Type, Set Screws Type

2.0000 in	ID	50.80 mm
3.4252 in	SE	87.00 mm
Rp 5/4	PS	

Group No. OT 0095 - 1

SLB	UCHA 211 - 32
FYH	UCHA 211 - 32
NSK	UCEH 211 - 32 S

Figure MU 24

Standard Duty Hanger Units

Eccentric Locking Collar Type, Set Screws Type

2.0625 in	ID	52.39 mm
3.4252 in	SE	87.00 mm
Rp 5/4	PS	

Group No. OT 0096 - 1

SLB	UCHA 211 - 33
FYH	UCHA 211 - 33

Figure MU 24

Standard Duty Hanger Units

Eccentric Locking Collar Type, Set Screws Type

2.1250 in	ID	53.98 mm
3.4252 in	SE	87.00 mm
Rp 5/4	PS	

Group No. OT 0097 - 1

SLB	UCHA 211 - 34
FYH	UCHA 211 - 34
NSK	UCEH 211 - 34 S

Figure MU 24

Standard Duty Hanger Units

Eccentric Locking Collar Type, Set Screws Type

2.1654 in	ID	55.00 mm
3.4252 in	SE	87.00 mm
Rp 5/4	PS	

Group No. OT 0098 - 1		
SLB	UCHA 211	
FYH	UCHA 211	
NSK	UCEH 211	

Figure MU 24		
<i>Standard Duty Hanger Units</i>		
<i>Eccentric Locking Collar Type, Set Screws Type</i>		
2.1875 in	ID	55.56 mm
3.4252 in	SE	87.00 mm
Rp 5/4	PS	

Group No. OT 0099 - 1		
SLB	UCHA 211 - 35	
FYH	UCHA 211 - 35	

Figure MU 24		
<i>Standard Duty Hanger Units</i>		
<i>Eccentric Locking Collar Type, Set Screws Type</i>		
2.2500 in	ID	57.15 mm
4.0157 in	SE	102.00 mm
Rp 5/4	PS	

Group No. OT 0100 - 1		
SLB	UCHA 212 - 36	
FYH	UCHA 212 - 36	
NSK	UCEH 212 - 36 S	
NTN	UCHB 212 - 204 D 1	

Figure MU 24		
<i>Standard Duty Hanger Units</i>		
<i>Eccentric Locking Collar Type, Set Screws Type</i>		
2.3125 in	ID	58.74 mm
4.0157 in	SE	102.00 mm
Rp 5/4	PS	

Group No. OT 0101 - 1		
SLB	UCHA 212 - 37	
NTN	UCHB 212 - 205 D 1	

Figure MU 24		
<i>Standard Duty Hanger Units</i>		
<i>Eccentric Locking Collar Type, Set Screws Type</i>		
2.3622 in	ID	60.00 mm
4.0157 in	SE	102.00 mm
Rp 5/4	PS	

Group No. OT 0102 - 1		
SLB	UCHA 212	
FYH	UCHA 212	
NSK	UCEH 212	
NTN	UCHB 212 D 1	
SEALMASTER	SEHB - 212	

Figure MU 24		
<i>Standard Duty Hanger Units</i>		
<i>Eccentric Locking Collar Type, Set Screws Type</i>		
2.3750 in	ID	60.33 mm
4.0157 in	SE	102.00 mm
Rp 5/4	PS	

Group No. OT 0103 - 1		
SLB	UCHA 212 - 38	
FYH	UCHA 212 - 38	
NSK	UCEH 212 - 38 S	
NTN	UCHB 212 - 206 D 1	
SEALMASTER	SEHB - 38	

Figure MU 24		
<i>Standard Duty Hanger Units</i>		
<i>Eccentric Locking Collar Type, Set Screws Type</i>		
2.4375 in	ID	61.91 mm
4.0157 in	SE	102.00 mm
Rp 5/4	PS	

Group No. OT 0104 - 1		
SLB	UCHA 212 - 39	
FYH	UCHA 212 - 39	
NTN	UCHB 212 - 207 D 1	
SEALMASTER	SEHB - 39	

Figure MU 24		
<i>Standard Duty Hanger Units</i>		
<i>Eccentric Locking Collar Type, Set Screws Type</i>		
2.5000 in	ID	63.50 mm
4.6063 in	SE	117.00 mm
Rp 3/2	PS	

Group No. OT 0105 - 1		
SLB	UCHA 213 - 40	
FYH	UCHA 213 - 40	
NSK	UCEH 213 - 40 S	
NTN	UCHB 213 - 208 D 1	

Figure MU 24		
<i>Standard Duty Hanger Units</i>		
<i>Eccentric Locking Collar Type, Set Screws Type</i>		
2.5591 in	ID	65.00 mm
4.6063 in	SE	117.00 mm
Rp 3/2	PS	

Group No. OT 0106 - 1		
SLB	UCHA 213	
FYH	UCHA 213	
NSK	UCEH 213	
NTN	UCHB 213 D 1	

Figure MU 24		
<i>Standard Duty Hanger Units</i>		
<i>Eccentric Locking Collar Type, Set Screws Type</i>		
2.5625 in	ID	65.09 mm
4.6063 in	SE	117.00 mm
Rp 3/2	PS	

Group No. OT 0107 - 1		
SLB	UCHA 213 - 41	
FYH	UCHA 213 - 41	

Figure MU 24		
<i>Standard Duty Hanger Units</i>		
<i>Eccentric Locking Collar Type, Set Screws Type</i>		
2.6250 in	ID	66.68 mm
4.6063 in	SE	117.00 mm
Rp 3/2	PS	

Group No. OT 0108 - 1		
SLB	UCHA 214 - 42	
FYH	UCHA 214 - 42	

Figure MU 24		
<i>Standard Duty Hanger Units</i>		
<i>Eccentric Locking Collar Type, Set Screws Type</i>		
2.6875 in	ID	68.26 mm
4.6063 in	SE	117.00 mm
Rp 3/2	PS	

Group No. OT 0109 - 1		
SLB	UCHA 214 - 43	
FYH	UCHA 214 - 43	

Figure MU 24		
<i>Standard Duty Hanger Units</i>		
<i>Eccentric Locking Collar Type, Set Screws Type</i>		
2.7500 in	ID	69.85 mm
4.6063 in	SE	117.00 mm
Rp 3/2	PS	

Group No. OT 0110 - 1		
SLB	UCHA 214 - 44	
FYH	UCHA 214 - 44	

Figure MU 24 

Standard Duty Hanger Units
Eccentric Locking Collar Type, Set Screws Type

2.7559 in	ID	70.00 mm
4.6063 in	SE	117.00 mm
Rp 3/2	PS	

Group No. OT 0111 - 1

SLB	UCHA 214
FYH	UCHA 214

Figure MU 24 

Standard Duty Hanger Units
Eccentric Locking Collar Type, Set Screws Type

2.8125 in	ID	71.44 mm
4.6063 in	SE	117.00 mm
Rp 3/2	PS	

Group No. OT 0112 - 1

SLB	UCHA 215 - 45
FYH	UCHA 215 - 45

Figure MU 24 

Standard Duty Hanger Units
Eccentric Locking Collar Type, Set Screws Type

2.8750 in	ID	73.03 mm
4.6063 in	SE	117.00 mm
Rp 3/2	PS	

Group No. OT 0113 - 1

SLB	UCHA 215 - 46
FYH	UCHA 215 - 46

Figure MU 24 

Standard Duty Hanger Units
Eccentric Locking Collar Type, Set Screws Type

2.9375 in	ID	74.61 mm
4.6063 in	SE	117.00 mm
Rp 3/2	PS	

Group No. OT 0114 - 1

SLB	UCHA 215 - 47
SEALMASTER	SEHB - 47

Figure MU 24 

Standard Duty Hanger Units
Eccentric Locking Collar Type, Set Screws Type

2.9528 in	ID	75.00 mm
4.6063 in	SE	117.00 mm
Rp 3/2	PS	

Group No. OT 0115 - 1

SLB	UCHA 215
FYH	UCHA 215
SEALMASTER	SEHB - 215

Figure MU 24 

Standard Duty Hanger Units
Eccentric Locking Collar Type, Set Screws Type

3.0000 in	ID	76.20 mm
4.6063 in	SE	117.00 mm
Rp 3/2	PS	

Group No. OT 0116 - 1

SLB	UCHA 215 - 48
FYH	UCHA 215 - 48

Figure MU 26 

Standard Duty Take - Up Units - Cast Housing
Eccentric Locking Collar Type, Set Screws Type

0.4724 in	ID	12.00 mm
2.9921 in	SH	76.00 mm
0.4724 in	SW	12.00 mm

Group No. OT 0117 - 1

SLB	UCT 201
ASAHI	UCT 201
FYH	UCT 201
NACHI	UCT 201
NSK	UCT 201
NTN	UCT 201 D 1

Figure MU 26 

Standard Duty Take - Up Units - Cast Housing
Eccentric Locking Collar Type, Set Screws Type

0.5000 in	ID	12.70 mm
2.9921 in	SH	76.00 mm
0.4724 in	SW	12.00 mm

Group No. OT 0118 - 1

SLB	UCT 201 - 8
ASAHI	UCT 201 - 8
FYH	UCT 201 - 8
NACHI	UCT 201 - 8
NSK	UCT 201 - 8 S
NTN	UCT 201 - 008 D 1

Figure MU 26 

Standard Duty Take - Up Units - Cast Housing
Eccentric Locking Collar Type, Set Screws Type

0.5625 in	ID	14.29 mm
2.9921 in	SH	76.00 mm
0.4724 in	SW	12.00 mm

Group No. OT 0119 - 1

SLB	UCT 202 - 9
ASAHI	UCT 202 - 9
NACHI	UCT 202 - 9
NTN	UCT 202 - 009 D 1

Figure MU 26 

Standard Duty Take - Up Units - Cast Housing
Eccentric Locking Collar Type, Set Screws Type

0.5906 in	ID	15.00 mm
2.9921 in	SH	76.00 mm
0.4724 in	SW	12.00 mm

Group No. OT 0120 - 1

SLB	UCT 202
ASAHI	UCT 202
FYH	UCT 202
NACHI	UCT 202
NSK	UCT 202
NTN	UCT 202 D 1

Figure MU 26 

Standard Duty Take - Up Units - Cast Housing
Eccentric Locking Collar Type, Set Screws Type

0.6250 in	ID	15.88 mm
2.9921 in	SH	76.00 mm
0.4724 in	SW	12.00 mm

Group No. OT 0121 - 1

SLB	UCT 202 - 10
ASAHI	UCT 202 - 10
FYH	UCT 202 - 10
NACHI	UCT 202 - 10
NSK	UCT 202 - 10 S
NTN	UCT 202 - 010 D 1

Figure MU 26 

Standard Duty Take - Up Units - Cast Housing
Eccentric Locking Collar Type, Set Screws Type

0.6693 in	ID	17.00 mm
2.9921 in	SH	76.00 mm
0.4724 in	SW	12.00 mm

Group No. OT 0122 - 1

SLB	UCT 203
ASAHI	UCT 203
FYH	UCT 203
NACHI	UCT 203
NSK	UCT 203
NTN	UCT 203 D 1

Figure MU 26 

Standard Duty Take - Up Units - Cast Housing
Eccentric Locking Collar Type, Set Screws Type

0.6875 in	ID	17.46 mm
2.9921 in	SH	76.00 mm
0.4724 in	SW	12.00 mm

Group No. OT 0123 - 1

SLB	UCT 203 - 11
ASAHI	UCT 203 - 11
NACHI	UCT 203 - 11
NTN	UCT 203 - 011 D 1

Figure MU 26 

Standard Duty Take - Up Units - Cast Housing
Eccentric Locking Collar Type, Set Screws Type

0.7500 in	ID	19.05 mm
2.9921 in	SH	76.00 mm
0.4724 in	SW	12.00 mm

Group No. OT 0124 - 1

SLB	UCT 204 - 12
ASAHI	UCT 204 - 12
FYH	UCT 204 - 12
INA	RTUY 3/4"
KOYO	UCT 204 - 12
NACHI	UCT 204 - 12
NSK	UCT 204 - 12 S
NTN	UCT 204 - 012 D 1
SKF	TBY 3/4 TM

Group No. OT 0124 - 2

SLB	UELST 204 - 12
INA	RTUE 3/4" AH 01
NTN	UELST 204 - 012 D 1 W 3
SKF	TBY 3/4 WM

Group No. OT 0124 - 3

SLB	SAT 204 - 12
SKF	TBY 3/4 FM

Figure MU 25 

Standard Duty Take - Up Units - Cast Housing
Set Screws Type

0.7500 in	ID	19.05 mm
2.9921 in	SH	76.00 mm
0.5315 in	SW	13.50 mm

Group No. OT 0125 - 1

SLB	UCST 204 - 12
ASAHI	UCST 204 - 12
BROWNING	VTWS - 212
LINK BELT	TH 3 - U 212 N
RHP	ST 3/4
SEALMASTER	ST - 12

Group No. OT 0125 - 2

SLB	UELST 204 - 12
BROWNING	VTWE - 212
FAFNIR	RTU - 3/4
RHP	ST 3/4 DEC

Group No. OT 0125 - 3

SLB	SAST 204 - 12
FAFNIR	VTU - 3/4
INA	PTUE 3/4" AH 01
RHP	ST 3/4 EC

Figure MU 26 

Standard Duty Take - Up Units - Cast Housing
Eccentric Locking Collar Type, Set Screws Type

0.7874 in	ID	20.00 mm
2.9921 in	SH	76.00 mm
0.4724 in	SW	12.00 mm

Group No. OT 0126 - 1

SLB	UCT 204
ASAHI	UCT 204
FYH	UCT 204
INA	RTUY 20
KOYO	UCT 204
NACHI	UCT 204
NSK	UCT 204
NTN	UCT 204 D 1
SKF	TBY 20 TM

Group No. OT 0126 - 2

SLB	UELST 204
INA	RTUE 20 AH 01
KOYO	GAT 1012 MBJ
NSK	EWT 204
NTN	UELST 204 D 1 W 3
SKF	TBY 20 WM

Group No. OT 0126 - 3

SLB	SAT 204
KOYO	GARAT 012 MAJ
SKF	TBY 20 FM

Figure MU 28 

Standard Duty Take - Up Units - Cast Housing
Adapter Type

0.7874 in	ID	20.00 mm
2.9921 in	SH	76.00 mm
0.4724 in	SW	12.00 mm

Group No. OT 0127 - 1

SLB	UKT 205
FYH	UKT 205
NACHI	UKT 205
NSK	UKT 205
NTN	UKT 205 D 1

Figure MU 25 

Standard Duty Take - Up Units - Cast Housing
Set Screws Type

0.7874 in	ID	20.00 mm
2.9921 in	SH	76.00 mm
0.5315 in	SW	13.50 mm

Group No. OT 0128 - 1

SLB	UCST 204
ASAHI	UCST 204
RHP	ST 20
SEALMASTER	ST - 204
SNR	ST 20

Group No. OT 0128 - 2

SLB	UELST 204
FAFNIR	RTU - 20
RHP	ST 20 DEC

Group No. OT 0128 - 3

SLB	SAST 204
FAFNIR	VTU - 20
INA	PTUE 20 AH 01
RHP	ST 20 EC

Figure MU 26 

Standard Duty Take - Up Units - Cast Housing
Eccentric Locking Collar Type, Set Screws Type

0.8125 in	ID	20.64 mm
2.9921 in	SH	76.00 mm
0.4724 in	SW	12.00 mm

Group No. OT 0129 - 1

SLB	UCT 205 - 13
KOYO	UCT 205 - 13
NTN	UCT 205 - 013 D 1
SKF	TBY 13/16 TM

Group No. OT 0129 - 2

SLB	UELST 205 - 13
NTN	UELST 205 - 013 D 1 W 3
SKF	TBY 13/16 WM

Group No. OT 0129 - 3

SLB	SAT 205 - 13
SKF	TBY 13/16 FM

Figure MU 25 

Standard Duty Take - Up Units - Cast Housing
Set Screws Type

0.8125 in	ID	20.64 mm
2.9921 in	SH	76.00 mm
0.5315 in	SW	13.50 mm

Group No. OT 0130 - 1

SLB	UCST 205 - 13
SEALMASTER	ST - 13

Group No. OT 0130 - 2

SLB	UELST 205 - 13
FAFNIR	RTU - 13/16

Group No. OT 0130 - 3	
SLB	SAST 205 - 13
FAFNIR	VTU - 13/16

Figure MU 26 	
<i>Standard Duty Take - Up Units - Cast Housing</i>	
<i>Eccentric Locking Collar Type, Set Screws Type</i>	

0.8750 in	ID	22.23 mm
2.9921 in	SH	76.00 mm
0.4724 in	SW	12.00 mm

Group No. OT 0131 - 1	
SLB	UCT 205 - 14
ASAHI	UCT 205 - 14
FYH	UCT 205 - 14
INA	RTUY 7/8"
KOYO	UCT 205 - 14
NACHI	UCT 205 - 14
NSK	UCT 205 - 14 S
NTN	UCT 205 - 014 D 1
SKF	TBY 7/8 TM

Group No. OT 0131 - 2	
SLB	UELST 205 - 14
INA	RTUE 7/8" AH 01
NTN	UELST 205 - 014 D 1 W 3
SKF	TBY 7/8 WM

Group No. OT 0131 - 3	
SLB	SAT 205 - 14
SKF	TBY 7/8 FM

Figure MU 25 	
<i>Standard Duty Take - Up Units - Cast Housing</i>	
<i>Set Screws Type</i>	

0.8750 in	ID	22.23 mm
2.9921 in	SH	76.00 mm
0.5315 in	SW	13.50 mm

Group No. OT 0132 - 1	
SLB	UCST 205 - 14
ASAHI	UCST 205 - 14
BROWNING	VTWS - 214
LINK BELT	TH 3 - U 214 N
RHP	ST 7/8
SEALMASTER	ST - 14

Group No. OT 0132 - 2	
SLB	UELST 205 - 14
BROWNING	VTWE - 214
FAFNIR	RTU - 7/8
RHP	ST 7/8 DEC

Group No. OT 0132 - 3	
SLB	SAST 205 - 14
FAFNIR	VTU - 7/8
INA	PTUE 7/8" AH 01
RHP	ST 7/8 EC

Figure MU 26 	
<i>Standard Duty Take - Up Units - Cast Housing</i>	
<i>Eccentric Locking Collar Type, Set Screws Type</i>	

0.9375 in	ID	23.81 mm
2.9921 in	SH	76.00 mm
0.4724 in	SW	12.00 mm

Group No. OT 0133 - 1	
SLB	UCT 205 - 15
ASAHI	UCT 205 - 15
FYH	UCT 205 - 15
KOYO	UCT 205 - 15
NACHI	UCT 205 - 15
NTN	UCT 205 - 015 D 1
SKF	TBY 15/16 TM

Group No. OT 0133 - 2	
SLB	UELST 205 - 15
INA	RTUE 15/16" AH 01
NTN	UELST 205 - 015 D 1 W 3
SKF	TBY 15/16 WM

Group No. OT 0133 - 3	
SLB	SAT 205 - 15
SKF	TBY 15/16 FM

Figure MU 25 	
<i>Standard Duty Take - Up Units - Cast Housing</i>	
<i>Set Screws Type</i>	

0.9375 in	ID	23.81 mm
2.9921 in	SH	76.00 mm
0.5315 in	SW	13.50 mm

Group No. OT 0134 - 1	
SLB	UCST 205 - 15
ASAHI	UCST 205 - 15
BROWNING	VTWS - 215
LINK BELT	TH 3 - U 215 N
RHP	ST 15/16
SEALMASTER	ST - 15

Group No. OT 0134 - 2	
SLB	UELST 205 - 15
BROWNING	VTWE - 215
FAFNIR	RTU - 15/16
RHP	ST 15/16 DEC

Group No. OT 0134 - 3	
SLB	SAST 205 - 15
FAFNIR	VTU - 15/16
RHP	ST 15/16 EC

Figure MU 26 	
<i>Standard Duty Take - Up Units - Cast Housing</i>	
<i>Eccentric Locking Collar Type, Set Screws Type</i>	

0.9843 in	ID	25.00 mm
2.9921 in	SH	76.00 mm
0.4724 in	SW	12.00 mm

Group No. OT 0135 - 1	
SLB	UCT 205
ASAHI	UCT 205
FYH	UCT 205
INA	RTUY 25
KOYO	UCT 205
NACHI	UCT 205
NSK	UCT 205
NTN	UCT 205 D 1
SKF	TBY 25 TM

Group No. OT 0135 - 2	
SLB	UELST 205
INA	RTUE 25 AH 01
KOYO	GAT 1100 MBJ
NSK	EWT 205
NTN	UELST 205 D 1 W 3
SKF	TBY 25 WM

Group No. OT 0135 - 3	
SLB	SAT 205
KOYO	GARAT 100 MAJ
SKF	TBY 25 FM

Figure MU 25 	
<i>Standard Duty Take - Up Units - Cast Housing</i>	
<i>Set Screws Type</i>	

0.9843 in	ID	25.00 mm
2.9921 in	SH	76.00 mm
0.5315 in	SW	13.50 mm

Group No. OT 0136 - 1	
SLB	UCST 205
ASAHI	UCST 205
RHP	ST 25
SEALMASTER	ST 205
SNR	ST 25

Group No. OT 0136 - 2	
SLB	UELST 205
FAFNIR	RTU - 25
RHP	ST 25 DEC

Group No. OT 0136 - 3	
SLB	SAST 205
FAFNIR	VTU - 25
INA	PTUE 25 AH 01
RHP	ST 25 EC

Figure MU 28 	
<i>Standard Duty Take - Up Units - Cast Housing</i>	
<i>Adapter Type</i>	

0.9843 in	ID	25.00 mm
3.5039 in	SH	89.00 mm
0.4724 in	SW	12.00 mm

Group No. OT 0137 - 1

SLB	UKT 206
FYH	UKT 206
NACHI	UKT 206
NSK	UKT 206
NTN	UKT 206 D 1

Figure MU 26

Standard Duty Take - Up Units - Cast Housing
Eccentric Locking Collar Type, Set Screws Type

1.0000 in	ID	25.40 mm
2.9921 in	SH	76.00 mm
0.4724 in	SW	12.00 mm

Group No. OT 0138 - 1

SLB	UCT 205 - 16
ASAHI	UCT 205 - 16
FYH	UCT 205 - 16
INA	RTUY 1"
KOYO	UCT 205 - 16
NACHI	UCT 205 - 16
NSK	UCT 205 - 16 S
NTN	UCT 205 - 100 D 1
SKF	TBY 1 TM

Group No. OT 0138 - 2

SLB	UELST 205 - 16
INA	RTUE 1" AH 01
NTN	UELST 205 - 100 D 1 W 3
SKF	TBY 1 WM

Group No. OT 0138 - 3

SLB	SAT 205 - 16
SKF	TBY 1 FM

Figure MU 25

Standard Duty Take - Up Units - Cast Housing
Set Screws Type

1.0000 in	ID	25.40 mm
2.9921 in	SH	76.00 mm
0.5315 in	SW	13.50 mm

Group No. OT 0139 - 1

SLB	UCST 205 - 16
ASAHI	UCST 205 - 16
BROWNING	VTWS - 216
LINK BELT	TH 3 - U 216 N
RHP	ST 1
SEALMASTER	ST - 16

Group No. OT 0139 - 2

SLB	UELST 205 - 16
BROWNING	VTWE - 216
FAFNIR	RTU - 1
RHP	ST 1 EDEC

Group No. OT 0139 - 3

SLB	SAST 205 - 16
FAFNIR	VYU - 1
INA	PTUE 1" AH 01
RHP	ST 1 EC

Figure MU 26

Standard Duty Take - Up Units - Cast Housing
Eccentric Locking Collar Type, Set Screws Type

1.0625 in	ID	26.99 mm
3.5039 in	SH	89.00 mm
0.4724 in	SW	12.00 mm

Group No. OT 0140 - 1

SLB	UCT 206 - 17
ASAHI	UCT 206 - 17
NACHI	UCT 206 - 17
NTN	UCT 206 - 101 D 1
SKF	TBY 1 - 1/16 TM

Group No. OT 0140 - 2

SLB	UELST 206 - 17
NTN	UELST 206 - 101 D 1 W 3
SKF	TBY 1 - 1/16 WM

Group No. OT 0140 - 3

SLB	SAT 206 - 17
SKF	TBY 1 - 1/16 FM

Figure MU 25

Standard Duty Take - Up Units - Cast Housing
Set Screws Type

1.0625 in	ID	26.99 mm
3.5039 in	SH	89.00 mm
0.5315 in	SW	13.50 mm

Group No. OT 0141 - 1

SLB	UCST 206 - 17
ASAHI	UCST 206 - 17
SEALMASTER	ST - 17

Group No. OT 0141 - 2

SLB	UELST 206 - 17
FAFNIR	RTU - 1 - 1/16

Group No. OT 0141 - 3

SLB	SAST 206 - 17
FAFNIR	VTU - 1 - 1/16
INA	PTUE 1 1/16" AH 01

Figure MU 26

Standard Duty Take - Up Units - Cast Housing
Eccentric Locking Collar Type, Set Screws Type

1.1250 in	ID	28.58 mm
3.5039 in	SH	89.00 mm
0.4724 in	SW	12.00 mm

Group No. OT 0142 - 1

SLB	UCT 206 - 18
ASAHI	UCT 206 - 18
FYH	UCT 206 - 18
INA	RTUY 1 1/8"
KOYO	UCT 206 - 18
NACHI	UCT 206 - 18
NSK	UCT 206 - 18 S
NTN	UCT 206 - 102 D 1
SKF	TBY 1 - 1/8 TM

Group No. OT 0142 - 2

SLB	UELST 206 - 18
INA	RTUE 1 1/8" AH 01
NTN	UELST 206 - 102 D 1 W 3
SKF	TBY 1 - 1/8 WM

Group No. OT 0142 - 3

SLB	SAT 206 - 18
SKF	TBY 1 - 1/8 FM

Figure MU 25

Standard Duty Take - Up Units - Cast Housing
Set Screws Type

1.1250 in	ID	28.58 mm
3.5039 in	SH	89.00 mm
0.5315 in	SW	13.50 mm

Group No. OT 0143 - 1

SLB	UCST 206 - 18
ASAHI	UCST 206 - 18
BROWNING	VTWS - 218
LINK BELT	TH 3 - U 218 N
RHP	ST 1 1/8
SEALMASTER	ST - 18

Group No. OT 0143 - 2

SLB	UELST 206 - 18
BROWNING	VTWE - 218
FAFNIR	RTU - 1 - 1/8
RHP	ST 1 1/8 DEC

Group No. OT 0143 - 3

SLB	SAST 206 - 18
FAFNIR	VTU - 1 - 1/8
INA	PTUE 1 1/8" AH 01
RHP	ST 1 1/8 EC

Figure MU 26

Standard Duty Take - Up Units - Cast Housing
Eccentric Locking Collar Type, Set Screws Type

1.1811 in	ID	30.00 mm
3.5039 in	SH	89.00 mm
0.4724 in	SW	12.00 mm

Group No. OT 0144 - 1

SLB	UCT 206
ASAHI	UCT 206
FYH	UCT 206
INA	RTUY 30
KOYO	UCT 206
NACHI	UCT 206
NSK	UCT 206
NTN	UCT 206 D 1
SKF	TBY 30 TM

Group No. OT 0144 - 2

SLB	UELST 206
INA	RTUE 30 AH 01
KOYO	GAT 1103 MBJ
NSK	EWT 206
NTN	UELST 206 D 1 W 3
SKF	TBY 30 WM

Group No. OT 0144 - 3

SLB	SAT 206
KOYO	GARAT 103 MAJ
SKF	TBY 30 FM

Figure MU 28

Standard Duty Take - Up Units - Cast Housing
Adapter Type

1.1811 in	ID	30.00 mm
3.5039 in	SH	89.00 mm
0.4724 in	SW	12.00 mm

Group No. OT 0145 - 1

SLB	UKT 207
FYH	UKT 207
NACHI	UKT 207
NSK	UKT 207
NTN	UKT 207 D 1

Figure MU 25

Standard Duty Take - Up Units - Cast Housing
Set Screws Type

1.1811 in	ID	30.00 mm
3.5039 in	SH	89.00 mm
0.5315 in	SW	13.50 mm

Group No. OT 0146 - 1

SLB	UCST 206
ASAHI	UCST 206

RHP	ST 30
SEALMASTER	ST - 206
SNR	ST 30

Group No. OT 0146 - 2

SLB	UELST 206
FAFNIR	RTU - 30
RHP	ST 30 DEC

Group No. OT 0146 - 3

SLB	SAST 206
FAFNIR	VTU - 30
INA	PTUE 30 AH 01
RHP	ST 30 EC

Figure MU 26

Standard Duty Take - Up Units - Cast Housing
Eccentric Locking Collar Type, Set Screws Type

1.1875 in	ID	30.16 mm
3.5039 in	SH	89.00 mm
0.4724 in	SW	12.00 mm

Group No. OT 0147 - 1

SLB	UCT 206 - 19
ASAHI	UCT 206 - 19
FYH	UCT 206 - 19
KOYO	UCT 206 - 19
NACHI	UCT 206 - 19
NTN	UCT 206 - 103 D 1
SKF	TBY 1 - 3/16 TM

Group No. OT 0147 - 2

SLB	UELST 206 - 19
INA	RTUE 1 3/16" AH 01
NTN	UELST 206 - 103 D 1 W 3
SKF	TBY 1 - 3/16 WM

Group No. OT 0147 - 3

SLB	SAT 206 - 19
SKF	TBY 1 - 3/16 FM

Figure MU 25

Standard Duty Take - Up Units - Cast Housing
Set Screws Type

1.1875 in	ID	30.16 mm
3.5039 in	SH	89.00 mm
0.5315 in	SW	13.50 mm

Group No. OT 0148 - 1

SLB	UCST 206 - 19
ASAHI	UCST 206 - 19
BROWNING	VTWS - 219
LINK BELT	TH 3 - U 219 N
RHP	ST 1 3/16
SEALMASTER	ST - 19

Group No. OT 0148 - 2

SLB	UELST 206 - 19
BROWNING	VTWE - 219
FAFNIR	RTU - 1 - 3/16
RHP	ST 1 3/16 DEC

Group No. OT 0148 - 3

SLB	SAST 206 - 19
FAFNIR	VTU - 1 - 3/16
INA	PTUE 1 3/16" AH 01
RHP	ST 1 3/16 EC

Figure MU 26

Standard Duty Take - Up Units - Cast Housing
Eccentric Locking Collar Type, Set Screws Type

1.2500 in	ID	31.75 mm
3.5039 in	SH	89.00 mm
0.4724 in	SW	12.00 mm

Group No. OT 0149 - 1

SLB	UCT 206 - 20
INA	RTUY 1 1/4" - 206
NTN	UCT 206 - 104 D 1
SKF	TBY 1 - 1/4 ATM

Group No. OT 0149 - 2

SLB	UELST 206 - 20
INA	RTUE 1 1/4" - 206 AH 01
NTN	UELST 206 - 104 D 1 W 3
SKF	TBY 1 - 1/4 AWM

Group No. OT 0149 - 3

SLB	SAT 206 - 20
SKF	TBY 1 - 1/4 AFM

Figure MU 26

Standard Duty Take - Up Units - Cast Housing
Eccentric Locking Collar Type, Set Screws Type

1.2500 in	ID	31.75 mm
3.5039 in	SH	89.00 mm
0.4724 in	SW	12.00 mm

Group No. OT 0150 - 1

SLB	UCT 207 - 20
ASAHI	UCT 207 - 20
FYH	UCT 207 - 20
INA	RTUY 1 1/4"
KOYO	UCT 207 - 20
NACHI	UCT 207 - 20
NSK	UCT 207 - 20 S
NTN	UCT 207 - 104 D 1
SKF	TBY 1 - 1/4 TM

Group No. OT 0150 - 2

SLB	UELST 207 - 20
INA	RTUE 1 1/4" AH 01
NTN	UELST 207 - 104 D 1 W 3
SKF	TBY 1 - 1/4 WM

Group No. OT 0150 - 3		
SLB	SAT 207 - 20	
SKF	TBY 1 - 1/4 FM	

Figure MU 25

Standard Duty Take - Up Units - Cast Housing
Set Screws Type

1.2500 in	ID	31.75 mm
3.5039 in	SH	89.00 mm
0.5315 in	SW	13.50 mm

Group No. OT 0151 - 1

SLB	UCST 206 - 20	
BROWNING	VTWS - 220	
LINK BELT	TH 3 - U 2 E 20 N	
RHP	ST 1 1/4 R	
SEALMASTER	ST - 20 R	

Group No. OT 0151 - 2

SLB	UELST 206 - 20	
BROWNING	VTWE - 220	
RHP	ST 1 1/4 DECR	

Group No. OT 0151 - 3

SLB	SAST 206 - 20	
INA	PTUE 1 1/4" - 206 AH 01	
RHP	ST 1 1/4 ECR	

Figure MU 25

Standard Duty Take - Up Units - Cast Housing
Set Screws Type

1.2500 in	ID	31.75 mm
3.5039 in	SH	89.00 mm
0.5315 in	SW	13.50 mm

Group No. OT 0152 - 1

SLB	UCST 207 - 20	
ASAHI	UCST 207 - 20	
LINK BELT	TH 3 - 220 N	
RHP	ST 1 1/4	
SEALMASTER	ST - 20	

Group No. OT 0152 - 2

SLB	UELST 207 - 20	
FAFNIR	RTU - 1 - 1/4	
RHP	ST 1 1/4 DEC	

Group No. OT 0152 - 3

SLB	SAST 207 - 20	
FAFNIR	VTU - 1 - 1/4	
INA	PTUE 1 1/4" AH 01	
RHP	ST 1 1/4 EC	

Figure MU 26

Standard Duty Take - Up Units - Cast Housing
Eccentric Locking Collar Type, Set Screws Type

1.3125 in	ID	33.34 mm
3.5039 in	SH	89.00 mm
0.4724 in	SW	12.00 mm

Group No. OT 0153 - 1

SLB	UCT 207 - 21	
ASAHI	UCT 207 - 21	
FYH	UCT 207 - 21	
KOYO	UCT 207 - 21	
NACHI	UCT 207 - 21	
NTN	UCT 207 - 105 D 1	
SKF	TBY 1 - 5/16 TM	

Group No. OT 0153 - 2

SLB	UELST 207 - 21	
NTN	UELST 207 - 105 D 1 W 3	
SKF	TBY 1 - 5/16 WM	

Group No. OT 0153 - 3

SLB	SAT 207 - 21	
SKF	TBY 1 - 5/16 FM	

Figure MU 25

Standard Duty Take - Up Units - Cast Housing
Set Screws Type

1.3125 in	ID	33.34 mm
3.5039 in	SH	89.00 mm
0.5315 in	SW	13.50 mm

Group No. OT 0154 - 1

SLB	UCST 207 - 21	
ASAHI	UCST 207 - 21	
SEALMASTER	ST - 21	

Group No. OT 0154 - 2

SLB	UELST 207 - 21	
FAFNIR	RTU - 1 - 5/16	

Group No. OT 0154 - 3

SLB	SAST 207 - 21	
FAFNIR	VTU - 1 - 5/16	

Figure MU 26

Standard Duty Take - Up Units - Cast Housing
Eccentric Locking Collar Type, Set Screws Type

1.3750 in	ID	34.93 mm
3.5039 in	SH	89.00 mm
0.4724 in	SW	12.00 mm

Group No. OT 0155 - 1

SLB	UCT 207 - 22	
ASAHI	UCT 207 - 22	
FYH	UCT 207 - 22	
KOYO	UCT 207 - 22	
NACHI	UCT 207 - 22	
NSK	UCT 207 - 22 S	
NTN	UCT 207 - 106 D 1	
SKF	TBY 1 - 3/8 TM	

Group No. OT 0155 - 2

SLB	UELST 207 - 22	
NTN	UELST 207 - 106 D 1 W 3	
SKF	TBY 1 - 3/8 WM	

Group No. OT 0155 - 3

SLB	SAT 207 - 22	
SKF	TBY 1 - 3/8 FM	

Figure MU 25

Standard Duty Take - Up Units - Cast Housing
Set Screws Type

1.3750 in	ID	34.93 mm
3.5039 in	SH	89.00 mm
0.5315 in	SW	13.50 mm

Group No. OT 0156 - 1

SLB	UCST 207 - 22	
ASAHI	UCST 207 - 22	
BROWNING	VTWS - 222	
LINK BELT	TH 3 - U 222 N	
RHP	ST 1 3/8	
SEALMASTER	ST - 22	

Group No. OT 0156 - 2

SLB	UELST 207 - 22	
BROWNING	VTWE - 222	
FAFNIR	RTU - 1 - 3/8	
RHP	ST 1 3/8 DEC	

Group No. OT 0156 - 3

SLB	SAST 207 - 22	
FAFNIR	VTU - 1 - 3/8	
RHP	ST 1 3/8 EC	

Figure MU 26

Standard Duty Take - Up Units - Cast Housing
Eccentric Locking Collar Type, Set Screws Type

1.3780 in	ID	35.00 mm
3.5039 in	SH	89.00 mm
0.4724 in	SW	12.00 mm

Group No. OT 0157 - 1

SLB	UCT 207	
ASAHI	UCT 207	
FYH	UCT 207	
INA	RTUY 35	
KOYO	UCT 207	
NACHI	UCT 207	
NSK	UCT 207	
NTN	UCT 207 D 1	
SKF	TBY 35 TM	

Group No. OT 0157 - 2

SLB	UELST 207	
INA	RTUE 35 AH 01	

KOYO	GAT 1106 MBJ
NSK	EWT 207
NTN	UELT 207 D 1 W 3
SKF	TBY 35 WM

Group No. OT 0157 - 3

SLB	SAT 207
KOYO	GARAT 106 MAJ
SKF	TBY 35 FM

Figure MU 25

Standard Duty Take - Up Units - Cast Housing
Set Screws Type



1.3780 in	ID	35.00 mm
3.5039 in	SH	89.00 mm
0.5315 in	SW	13.50 mm

Group No. OT 0158 - 1

SLB	UCST 207
ASAHI	UCST 207
RHP	ST 35
SEALMASTER	ST - 207
SNR	ST 35

Group No. OT 0158 - 2

SLB	UELST 207
FAFNIR	RTU - 35
RHP	ST 35 DEC

Group No. OT 0158 - 3

SLB	SAST 207
FAFNIR	VTU - 35
INA	PTUE 35 AH 01
RHP	ST 35 EC

Figure MU 28

Standard Duty Take - Up Units - Cast Housing
Adapter Type



1.3780 in	ID	35.00 mm
4.0157 in	SH	102.00 mm
0.6299 in	SW	16.00 mm

Group No. OT 0159 - 1

SLB	UKT 208
FYH	UKT 208
NACHI	UKT 208
NSK	UKT 208
NTN	UKT 208 D 1

Figure MU 26

Standard Duty Take - Up Units - Cast Housing
Eccentric Locking Collar Type, Set Screws Type



1.4375 in	ID	36.51 mm
3.5039 in	SH	89.00 mm
0.4724 in	SW	12.00 mm

Group No. OT 0160 - 1

SLB	UCT 207 - 23
ASAHI	UCT 207 - 23
FYH	UCT 207 - 23
KOYO	UCT 207 - 23
NACHI	UCT 207 - 23
NTN	UCT 207 - 107 D 1
SKF	TBY 1 - 7/16 TM

Group No. OT 0160 - 2

SLB	UELT 207 - 23
INA	RTUE 1 7/16" AH 01
NTN	UELT 207 - 107 D 1 W 3
SKF	TBY 1 - 7/16 WM

Group No. OT 0160 - 3

SLB	SAT 207 - 23
SKF	TBY 1 - 7/16 FM

Figure MU 25

Standard Duty Take - Up Units - Cast Housing
Set Screws Type



1.4375 in	ID	36.51 mm
3.5039 in	SH	89.00 mm
0.5315 in	SW	13.50 mm

Group No. OT 0161 - 1

SLB	UCST 207 - 23
ASAHI	UCST 207 - 23
BROWNING	VTWS - 223
LINK BELT	TH 3 - U 223 N
RHP	ST 1 7/16
SEALMASTER	ST - 23

Group No. OT 0161 - 2

SLB	UELST 207 - 23
BROWNING	VTWE - 223
FAFNIR	RTU - 1 - 7/16
RHP	ST 1 7/16 DEC

Group No. OT 0161 - 3

SLB	SAST 207 - 23
FAFNIR	VTU - 1 - 7/16
INA	PTUE 1 7/16" AH 01
RHP	ST 1 7/16 EC

Figure MU 25

Standard Duty Take - Up Units - Cast Housing
Set Screws Type



1.5000 in	ID	38.10 mm
3.9764 in	SH	101.00 mm
0.6890 in	SW	17.50 mm

Group No. OT 0162 - 1

SLB	UCST 208 - 24
ASAHI	UCST 208 - 24

BROWNING	VTWS - 224
LINK BELT	TH 3 - U 224 N
RHP	ST 1 1/2
SEALMASTER	ST - 24

Group No. OT 0162 - 2

SLB	UELST 208 - 24
BROWNING	VTWE - 224
FAFNIR	RTU - 1 - 1/2
RHP	ST 1 1/2 DEC

Group No. OT 0162 - 3

SLB	SAST 208 - 24
FAFNIR	VTU - 1 - 1/2
INA	PTUE 1 1/2" AH 01
RHP	ST 1 1/2 EC

Figure MU 26

Standard Duty Take - Up Units - Cast Housing
Eccentric Locking Collar Type, Set Screws Type



1.5000 in	ID	38.10 mm
4.0157 in	SH	102.00 mm
0.6299 in	SW	16.00 mm

Group No. OT 0163 - 1

SLB	UCT 208 - 24
ASAHI	UCT 208 - 24
FYH	UCT 208 - 24
INA	RTUY 1 1/2"
KOYO	UCT 208 - 24
NACHI	UCT 208 - 24
NSK	UCT 208 - 24 S
NTN	UCT 208 - 108 D 1
SKF	TBY 1 - 1/2 TM

Group No. OT 0163 - 2

SLB	UELST 208 - 24
INA	RTUE 1 1/2" AH 01
NTN	UELT 208 - 108 D 1 W 3
SKF	TBY 1 - 1/2 WM

Group No. OT 0163 - 3

SLB	SAT 208 - 24
SKF	TBY 1 - 1/2 FM

Figure MU 25

Standard Duty Take - Up Units - Cast Housing
Set Screws Type



1.5625 in	ID	39.69 mm
3.9764 in	SH	101.00 mm
0.6890 in	SW	17.50 mm

Group No. OT 0164 - 1

SLB	UCST 208 - 25
ASAHI	UCST 208 - 25
SEALMASTER	ST - 25

Group No. OT 0164 - 2	
SLB	UELST 208 - 25
FAFNIR	RTU - 1 - 9/16
Group No. OT 0164 - 3	
SLB	SAST 208 - 25
FAFNIR	VTU - 1 - 9/16

Figure MU 26		
<i>Standard Duty Take - Up Units - Cast Housing</i>		
<i>Eccentric Locking Collar Type, Set Screws Type</i>		
1.5625 in	ID	39.69 mm
4.0157 in	SH	102.00 mm
0.6299 in	SW	16.00 mm

Group No. OT 0165 - 1	
SLB	UCT 208 - 25
ASAHI	UCT 208 - 25
FYH	UCT 208 - 25
KOYO	UCT 208 - 25
NACHI	UCT 208 - 25
NTN	UCT 208 - 109 D 1
SKF	TBY 1 - 9/16 TM

Group No. OT 0165 - 2	
SLB	UEL208 - 25
NTN	UEL208 - 109 D 1 W 3
SKF	TBY 1 - 9/16 WM

Group No. OT 0165 - 3	
SLB	SAT 208 - 25
SKF	TBY 1 - 9/16 FM

Figure MU 25		
<i>Standard Duty Take - Up Units - Cast Housing</i>		
<i>Set Screws Type</i>		
1.5748 in	ID	40.00 mm
3.9764 in	SH	101.00 mm
0.6890 in	SW	17.50 mm

Group No. OT 0166 - 1	
SLB	UCST 208
ASAHI	UCST 208
RHP	ST 40
SEALMASTER	ST - 208
SNR	ST 40

Group No. OT 0166 - 2	
SLB	UELST 208
FAFNIR	RTU - 40
RHP	ST 40 DEC

Group No. OT 0166 - 3	
SLB	SAST 208
FAFNIR	VTU - 40
INA	PTUE 40 AH 01
RHP	ST 40 EC

Figure MU 26		
<i>Standard Duty Take - Up Units - Cast Housing</i>		
<i>Eccentric Locking Collar Type, Set Screws Type</i>		
1.5748 in	ID	40.00 mm
4.0157 in	SH	102.00 mm
0.6299 in	SW	16.00 mm

Group No. OT 0167 - 1	
SLB	UCT 208
ASAHI	UCT 208
FYH	UCT 208
INA	RTUY 40
KOYO	UCT 208
NACHI	UCT 208
NSK	UCT 208
NTN	UCT 208 D 1
SKF	TBY 40 TM

Group No. OT 0167 - 2	
SLB	UEL208
INA	RTUE 40 AH 01
KOYO	GAT 1109 MBJ
NSK	EWT 208
NTN	UEL208 D 1 W 3
SKF	TBY 40 WM

Group No. OT 0167 - 3	
SLB	SAT 208
KOYO	GARAT 109 MAJ
SKF	TBY 40 FM

Figure MU 28		
<i>Standard Duty Take - Up Units - Cast Housing</i>		
<i>Adapter Type</i>		
1.5748 in	ID	40.00 mm
4.0157 in	SH	102.00 mm
0.6299 in	SW	16.00 mm

Group No. OT 0168 - 1	
SLB	UKT 209
FYH	UKT 209
NACHI	UKT 209
NSK	UKT 209
NTN	UKT 209 D 1

Figure MU 25		
<i>Standard Duty Take - Up Units - Cast Housing</i>		
<i>Set Screws Type</i>		
1.6250 in	ID	41.28 mm
3.9764 in	SH	101.00 mm
0.6890 in	SW	17.50 mm

Group No. OT 0169 - 1	
SLB	UCST 209 - 26
ASAHI	UCST 209 - 26

BROWNING	VTWS - 226
LINK BELT	TH 3 - U 226 N
RHP	ST 1 5/8
SEALMASTER	ST - 26

Group No. OT 0169 - 2	
SLB	UELST 209 - 26
BROWNING	VTWE - 226
FAFNIR	RTU - 1 - 5/8
RHP	ST 1 5/8 DEC

Group No. OT 0169 - 3	
SLB	SAST 209 - 26
FAFNIR	VTU - 1 - 5/8
RHP	ST 1 5/8 EC

Figure MU 26		
<i>Standard Duty Take - Up Units - Cast Housing</i>		
<i>Eccentric Locking Collar Type, Set Screws Type</i>		
1.6250 in	ID	41.28 mm
4.0157 in	SH	102.00 mm
0.6299 in	SW	16.00 mm

Group No. OT 0170 - 1	
SLB	UCT 209 - 26
ASAHI	UCT 209 - 26
FYH	UCT 209 - 26
KOYO	UCT 209 - 26
NACHI	UCT 209 - 26
NSK	UCT 209 - 26 S
NTN	UCT 209 - 110 D 1
SKF	TBY 1 - 5/8 TM

Group No. OT 0170 - 2	
SLB	UEL209 - 26
INA	RTUE 1 5/8" AH 01
NTN	UEL209 - 110 D 1 W 3
SKF	TBY 1 - 5/8 WM

Group No. OT 0170 - 3	
SLB	SAT 209 - 26
SKF	TBY 1 - 5/8 FM

Figure MU 25		
<i>Standard Duty Take - Up Units - Cast Housing</i>		
<i>Set Screws Type</i>		
1.6875 in	ID	42.86 mm
3.9764 in	SH	101.00 mm
0.6890 in	SW	17.50 mm

Group No. OT 0171 - 1	
SLB	UCST 209 - 27
ASAHI	UCST 209 - 27
BROWNING	VTWS - 227
LINK BELT	TH 3 - U 227 N
RHP	ST 1 11/16
SEALMASTER	ST - 27

Group No. OT 0171 - 2	
SLB	UELST 209 - 27
BROWNING	VTWE - 227
FAFNIR	RTU - 1 - 11/16
RHP	ST 1 11/16 DEC

Group No. OT 0171 - 3	
SLB	SAST 209 - 27
FAFNIR	VTU - 1 - 11/16
RHP	ST 1 11/16 EC

Figure MU 26 
Standard Duty Take - Up Units - Cast Housing
Eccentric Locking Collar Type, Set Screws Type

1.6875 in	ID	42.86 mm
4.0157 in	SH	102.00 mm
0.6299 in	SW	16.00 mm

Group No. OT 0172 - 1	
SLB	UCT 209 - 27
ASAHI	UCT 209 - 27
FYH	UCT 209 - 27
KOYO	UCT 209 - 27
NACHI	UCT 209 - 27
NTN	UCT 209 - 111 D 1
SKF	TBY 1 - 11/16 TM

Group No. OT 0172 - 2	
SLB	UELST 209 - 27
INA	RTUE 1 11/16" AH 01
NTN	UELST 209 - 111 D 1 W 3
SKF	TBY 1 - 11/16 WM

Group No. OT 0172 - 3	
SLB	SAT 209 - 27
SKF	TBY 1 - 11/16 FM

Figure MU 25 
Standard Duty Take - Up Units - Cast Housing
Set Screws Type

1.7500 in	ID	44.45 mm
3.9764 in	SH	101.00 mm
0.6890 in	SW	17.50 mm

Group No. OT 0173 - 1	
SLB	UCST 209 - 28
ASAHI	UCST 209 - 28
BROWNING	VTWS - 228
LINK BELT	TH 3 - U 228 N
RHP	ST 1 3/4
SEALMASTER	ST - 28

Group No. OT 0173 - 2	
SLB	UELST 209 - 28
BROWNING	VTWE - 228
FAFNIR	RTU - 1 - 3/4
RHP	ST 1 3/4 DEC

Group No. OT 0173 - 3	
SLB	SAST 209 - 28
FAFNIR	VTU - 1 - 3/4
INA	PTUE 1 3/4" AH 01
RHP	ST 1 3/4 EC

Figure MU 26 
Standard Duty Take - Up Units - Cast Housing
Eccentric Locking Collar Type, Set Screws Type

1.7500 in	ID	44.45 mm
4.0157 in	SH	102.00 mm
0.6299 in	SW	16.00 mm

Group No. OT 0174 - 1	
SLB	UCT 209 - 28
ASAHI	UCT 209 - 28
FYH	UCT 209 - 28
INA	RTUY 1 3/4"
KOYO	UCT 209 - 28
NACHI	UCT 209 - 28
NSK	UCT 209 - 28 S
NTN	UCT 209 - 112 D 1
SKF	TBY 1 - 3/4 TM

Group No. OT 0174 - 2	
SLB	UELST 209 - 28
INA	RTUE 1 3/4" AH 01
NTN	UELST 209 - 112 D 1 W 3
SKF	TBY 1 - 3/4 WM

Group No. OT 0174 - 3	
SLB	SAT 209 - 28
SKF	TBY 1 - 3/4 FM

Figure MU 25 
Standard Duty Take - Up Units - Cast Housing
Set Screws Type

1.7717 in	ID	45.00 mm
3.9764 in	SH	101.00 mm
0.6890 in	SW	17.50 mm

Group No. OT 0175 - 1	
SLB	UCST 209
ASAHI	UCST 209
RHP	ST 45
SEALMASTER	ST - 209
SNR	ST 45

Group No. OT 0175 - 2	
SLB	UELST 209
FAFNIR	RTU - 45
RHP	ST 45 DEC

Group No. OT 0175 - 3	
SLB	SAST 209
FAFNIR	VTU - 45
INA	PTUE 45 AH 01
RHP	ST 45 EC

Figure MU 26 
Standard Duty Take - Up Units - Cast Housing
Eccentric Locking Collar Type, Set Screws Type

1.7717 in	ID	45.00 mm
4.0157 in	SH	102.00 mm
0.6299 in	SW	16.00 mm

Group No. OT 0176 - 1	
SLB	UCT 209
ASAHI	UCT 209
FYH	UCT 209
INA	RTUY 45
KOYO	UCT 209
NACHI	UCT 209
NSK	UCT 209
NTN	UCT 209 D 1
SKF	TBY 45 TM

Group No. OT 0176 - 2	
SLB	UELST 209
INA	RTUE 45 AH 01
KOYO	GAT 1112 MBJ
NSK	EWT 209
NTN	UELST 209 D 1 W 3
SKF	TBY 45 WM

Group No. OT 0176 - 3	
SLB	SAT 209
KOYO	GARAT 112 MAJ
SKF	TBY 45 FM

Figure MU 28 
Standard Duty Take - Up Units - Cast Housing
Adapter Type

1.7717 in	ID	45.00 mm
4.0157 in	SH	102.00 mm
0.6299 in	SW	16.00 mm

Group No. OT 0177 - 1	
SLB	UKT 210
FYH	UKT 210
NACHI	UKT 210
NSK	UKT 210
NTN	UKT 210 D 1

Figure MU 25 
Standard Duty Take - Up Units - Cast Housing
Set Screws Type

1.8125 in	ID	46.04 mm
3.9764 in	SH	101.00 mm
0.6890 in	SW	17.50 mm

Group No. OT 0178 - 1	
SLB	UCST 210 - 29
SEALMASTER	ST - 29

Group No. OT 0178 - 2	
SLB	UELST 210 - 29
FAFNIR	RTU - 1 - 13/16
Group No. OT 0178 - 3	
SLB	SAST 210 - 29
FAFNIR	VTU - 1 - 13/16

Figure MU 26 		
<i>Standard Duty Take - Up Units - Cast Housing</i>		
<i>Eccentric Locking Collar Type, Set Screws Type</i>		
1.8125 in	ID	46.04 mm
4.0157 in	SH	102.00 mm
0.6299 in	SW	16.00 mm

Group No. OT 0179 - 1	
SLB	UCT 210 - 29
NTN	UCT 210 - 113 D 1

Group No. OT 0179 - 2	
SLB	UELT 210 - 29
NTN	UELT 210 - 113 D 1 W 3

Figure MU 25 		
<i>Standard Duty Take - Up Units - Cast Housing</i>		
<i>Set Screws Type</i>		
1.8750 in	ID	47.63 mm
3.9764 in	SH	101.00 mm
0.6890 in	SW	17.50 mm

Group No. OT 0180 - 1	
SLB	UCST 210 - 30
ASAHI	UCST 210 - 30
RHP	ST 1 7/8
SEALMASTER	ST - 30

Group No. OT 0180 - 2	
SLB	UELST 210 - 30
FAFNIR	RTU - 1 - 7/8
RHP	ST 1 7/8 DEC

Group No. OT 0180 - 3	
SLB	SAST 210 - 30
FAFNIR	VTU - 1 - 7/8
RHP	ST 1 7/8 EC

Figure MU 26 		
<i>Standard Duty Take - Up Units - Cast Housing</i>		
<i>Eccentric Locking Collar Type, Set Screws Type</i>		
1.8750 in	ID	47.63 mm
4.0157 in	SH	102.00 mm
0.6299 in	SW	16.00 mm

Group No. OT 0181 - 1	
SLB	UCT 210 - 30
ASAHI	UCT 210 - 30
FYH	UCT 210 - 30
KOYO	UCT 210 - 30
NACHI	UCT 210 - 30
NSK	UCT 210 - 30 S
NTN	UCT 210 - 114 D 1
SKF	TBY 1 - 7/8 TM

Group No. OT 0181 - 2	
SLB	UELT 210 - 30
NTN	UELT 210 - 114 D 1 W 3
SKF	TBY 1 - 7/8 WM

Group No. OT 0181 - 3	
SLB	SAT 210 - 30
SKF	TBY 1 - 7/8 FM

Figure MU 25 		
<i>Standard Duty Take - Up Units - Cast Housing</i>		
<i>Set Screws Type</i>		
1.9375 in	ID	49.21 mm
3.9764 in	SH	101.00 mm
0.6890 in	SW	17.50 mm

Group No. OT 0182 - 1	
SLB	UCST 210 - 31
ASAHI	UCST 210 - 31
BROWNING	VTWS - 231
LINK BELT	TH 3 - U 231 N
RHP	ST 1 15/16
SEALMASTER	ST - 31

Group No. OT 0182 - 2	
SLB	UELST 210 - 31
BROWNING	VTWE - 231
FAFNIR	RTU - 1 - 15/16
RHP	ST 1 15/16 DEC

Group No. OT 0182 - 3	
SLB	SAST 210 - 31
FAFNIR	VTU - 1 - 15/16
INA	PTUE 1 15/16" AH 01
RHP	ST 1 15/16 EC

Figure MU 26 		
<i>Standard Duty Take - Up Units - Cast Housing</i>		
<i>Eccentric Locking Collar Type, Set Screws Type</i>		
1.9375 in	ID	49.21 mm
4.0157 in	SH	102.00 mm
0.6299 in	SW	16.00 mm

Group No. OT 0183 - 1	
SLB	UCT 210 - 31
ASAHI	UCT 210 - 31

FYH	UCT 210 - 31
INA	RTUY 1 15/16"
KOYO	UCT 210 - 31
NACHI	UCT 210 - 31
NTN	UCT 210 - 115 D 1
SKF	TBY 1 - 15/16 TM

Group No. OT 0183 - 2	
SLB	UELT 210 - 31
INA	RTUE 1 15/16" AH 01
NTN	UELT 210 - 115 D 1 W 3
SKF	TBY 1 - 15/16 WM

Group No. OT 0183 - 3	
SLB	SAT 210 - 31
SKF	TBY 1 - 15/16 FM

Figure MU 25 		
<i>Standard Duty Take - Up Units - Cast Housing</i>		
<i>Set Screws Type</i>		
1.9685 in	ID	50.00 mm
3.9764 in	SH	101.00 mm
0.6890 in	SW	17.50 mm

Group No. OT 0184 - 1	
SLB	UCST 210
ASAHI	UCST 210
RHP	ST 50
SEALMASTER	ST - 210
SNR	ST 50

Group No. OT 0184 - 2	
SLB	UELST 210
FAFNIR	RTU - 50
RHP	ST 50 DEC

Group No. OT 0184 - 3	
SLB	SAST 210
FAFNIR	VTU - 50
INA	PTUE 50 AH 01
RHP	ST 50 EC

Figure MU 26 		
<i>Standard Duty Take - Up Units - Cast Housing</i>		
<i>Eccentric Locking Collar Type, Set Screws Type</i>		
1.9685 in	ID	50.00 mm
4.0157 in	SH	102.00 mm
0.6299 in	SW	16.00 mm

Group No. OT 0185 - 1	
SLB	UCT 210
ASAHI	UCT 210
FYH	UCT 210
INA	RTUY 50
KOYO	UCT 210

NACHI	UCT 210
NSK	UCT 210
NTN	UCT 210 D 1
SKF	TBY 50 TM

Group No. OT 0185 - 2

SLB	UELT 210
INA	RTUE 50 AH 01
KOYO	GAT 1115 MBJ
NSK	EWT 210
NTN	UELT 210 D 1 W 3
SKF	TBY 50 WM

Group No. OT 0185 - 3

SLB	SAT 210
KOYO	GARAT 115 MAJ
SKF	TBY 50 FM

Figure MU 28

Standard Duty Take - Up Units - Cast Housing Adapter Type

1.9685 in	ID	50.00 mm
5.1181 in	SH	130.00 mm
0.8661 in	SW	22.00 mm

Group No. OT 0186 - 1

SLB	UKT 211
FYH	UKT 211
NACHI	UKT 211
NSK	UKT 211
NTN	UKT 211 D 1

Figure MU 25

Standard Duty Take - Up Units - Cast Housing Set Screws Type

2.0000 in	ID	50.80 mm
3.9764 in	SH	101.00 mm
0.6890 in	SW	17.50 mm

Group No. OT 0187 - 1

SLB	UCST 210 - 32
LINK BELT	TH 3 - U 2 E 32 N
RHP	ST 2 R
SEALMASTER	ST - 32 R

Figure MU 26

Standard Duty Take - Up Units - Cast Housing Eccentric Locking Collar Type, Set Screws Type

2.0000 in	ID	50.80 mm
4.0157 in	SH	102.00 mm
0.6299 in	SW	16.00 mm

Group No. OT 0188 - 1

SLB	UCT 210 - 32
NTN	UCT 210 - 200 D 1

Group No. OT 0188 - 2

SLB	UELT 210 - 32
NTN	UELT 210 - 200 D 1 W 3

Figure MU 26

Standard Duty Take - Up Units - Cast Housing Eccentric Locking Collar Type, Set Screws Type

2.0000 in	ID	50.80 mm
5.1181 in	SH	130.00 mm
0.8661 in	SW	22.00 mm

Group No. OT 0189 - 1

SLB	UCT 211 - 32
ASAHI	UCT 211 - 32
FYH	UCT 211 - 32
INA	RTUY 2"
KOYO	UCT 211 - 32
NACHI	UCT 211 - 32
NSK	UCT 211 - 32 S
NTN	UCT 211 - 200 D 1
SKF	TBY 2 TM

Group No. OT 0189 - 2

SLB	UELT 211 - 32
NTN	UELT 211 - 200 D 1 W 3
SKF	TBY 2 WM

Group No. OT 0189 - 3

SLB	SAT 211 - 32
SKF	TBY 2 FM

Figure MU 25

Standard Duty Take - Up Units - Cast Housing Set Screws Type

2.0000 in	ID	50.80 mm
5.1181 in	SH	130.00 mm
1.0630 in	SW	27.00 mm

Group No. OT 0190 - 1

SLB	UCST 211 - 32
ASAHI	UCST 211 - 32
BROWNING	VTWS - 232
LINK BELT	TH 3 - U 232 N
RHP	ST 2
SEALMASTER	ST - 32 R

Group No. OT 0190 - 2

SLB	UELST 211 - 32
BROWNING	VTWE - 232
FAFNIR	RTU - 2
RHP	ST 2 DEC

Group No. OT 0190 - 3

SLB	SAST 211 - 32
FAFNIR	VTU - 2
INA	PTUE 2" AH 01

Figure MU 26

Standard Duty Take - Up Units - Cast Housing Eccentric Locking Collar Type, Set Screws Type

2.0625 in	ID	52.39 mm
5.1181 in	SH	130.00 mm
0.8661 in	SW	22.00 mm

Group No. OT 0191 - 1

SLB	UCT 211 - 33
ASAHI	UCT 211 - 33
NACHI	UCT 211 - 33
NTN	UCT 211 - 201 D 1

Group No. OT 0191 - 2

SLB	UELT 211 - 33
NTN	UELT 211 - 201 D 1 W 3

Figure MU 25

Standard Duty Take - Up Units - Cast Housing Set Screws Type

2.0625 in	ID	52.39 mm
5.1181 in	SH	130.00 mm
1.0630 in	SW	27.00 mm

Group No. OT 0192 - 1

SLB	UCST 211 - 33
ASAHI	UCST 211 - 33

Group No. OT 0192 - 2

SLB	UELST 211 - 33
FAFNIR	RTU - 2 - 1/16

Group No. OT 0192 - 3

SLB	SAST 211 - 33
FAFNIR	VTU - 2 - 1/16

Figure MU 26

Standard Duty Take - Up Units - Cast Housing Eccentric Locking Collar Type, Set Screws Type

2.1250 in	ID	53.98 mm
5.1181 in	SH	130.00 mm
0.8661 in	SW	22.00 mm

Group No. OT 0193 - 1

SLB	UCT 211 - 34
ASAHI	UCT 211 - 34
FYH	UCT 211 - 34
NACHI	UCT 211 - 34
NSK	UCT 211 - 34 S
NTN	UCT 211 - 202 D 1

Group No. OT 0193 - 2

SLB	UELT 211 - 34
NTN	UELT 211 - 202 D 1 W 3

Figure MU 25

Standard Duty Take - Up Units - Cast Housing
Set Screws Type

2.1250 in	ID	53.98 mm
5.1181 in	SH	130.00 mm
1.0630 in	SW	27.00 mm

Group No. OT 0194 - 1

SLB	UCST 211 - 34
ASAHI	UCST 211 - 34
RHP	ST 2 1/8
SEALMASTER	ST - 34

Group No. OT 0194 - 2

SLB	UELST 211 - 34
FAFNIR	RTU - 2 - 1/8
RHP	ST 2 1/8 DEC

Group No. OT 0194 - 3

SLB	SAST 211 - 34
FAFNIR	VTU - 2 - 1/8

Figure MU 26

Standard Duty Take - Up Units - Cast Housing
Eccentric Locking Collar Type, Set Screws Type

2.1654 in	ID	55.00 mm
5.1181 in	SH	130.00 mm
0.8661 in	SW	22.00 mm

Group No. OT 0195 - 1

SLB	UCT 211
ASAHI	UCT 211
FYH	UCT 211
INA	RTUY 55
KOYO	UCT 211
NACHI	UCT 211
NSK	UCT 211
NTN	UCT 211 D 1
SKF	TBY 55 TM

Group No. OT 0195 - 2

SLB	UELST 211
INA	RTUE 55 AH 01
NSK	EWT 211
NTN	UELST 211 D 1 W 3
SKF	TBY 55 WM

Group No. OT 0195 - 3

SLB	SAT 211
SKF	TBY 55 FM

Figure MU 28

Standard Duty Take - Up Units - Cast Housing
Adapter Type

2.1654 in	ID	55.00 mm
5.1181 in	SH	130.00 mm
0.8661 in	SW	22.00 mm

Group No. OT 0196 - 1

SLB	UKT 212
FYH	UKT 212
NACHI	UKT 212
NSK	UKT 212
NTN	UKT 212 D 1

Figure MU 25

Standard Duty Take - Up Units - Cast Housing
Set Screws Type

2.1654 in	ID	55.00 mm
5.1181 in	SH	130.00 mm
1.0630 in	SW	27.00 mm

Group No. OT 0197 - 1

SLB	UCST 211
ASAHI	UCST 211
RHP	ST 55
SNR	ST 55

Group No. OT 0197 - 2

SLB	UELST 211
FAFNIR	RTU - 55
RHP	ST 55 DEC

Group No. OT 0197 - 3

SLB	SAST 211
FAFNIR	VTU - 55
INA	PTUE 55 AH 01

Figure MU 26

Standard Duty Take - Up Units - Cast Housing
Eccentric Locking Collar Type, Set Screws Type

2.1875 in	ID	55.56 mm
5.1181 in	SH	130.00 mm
0.8661 in	SW	22.00 mm

Group No. OT 0198 - 1

SLB	UCT 211 - 35
ASAHI	UCT 211 - 35
FYH	UCT 211 - 35
KOYO	UCT 211 - 35
NACHI	UCT 211 - 35
NTN	UCT 211 - 203 D 1
SKF	TBY 2 - 3/16 TM

Group No. OT 0198 - 2

SLB	UELST 211 - 35
INA	RTUE 2 3/16" AH 01
NTN	UELST 211 - 203 D 1 W 3
SKF	TBY 2 - 3/16 WM

Group No. OT 0198 - 3

SLB	SAT 211 - 35
SKF	TBY 2 - 3/16 FM

Figure MU 25

Standard Duty Take - Up Units - Cast Housing
Set Screws Type

2.1875 in	ID	55.56 mm
5.1181 in	SH	130.00 mm
1.0630 in	SW	27.00 mm

Group No. OT 0199 - 1

SLB	UCST 211 - 35
ASAHI	UCST 211 - 35
BROWNING	VTWS - 235
LINK BELT	TH 3 - U 235 N
RHP	ST 2 3/16
SEALMASTER	ST - 35

Group No. OT 0199 - 2

SLB	UELST 211 - 35
BROWNING	VTWE - 235
FAFNIR	RTU - 2 - 3/16
RHP	ST 2 3/16 DEC

Group No. OT 0199 - 3

SLB	SAST 211 - 35
FAFNIR	VTU - 2 - 3/16
INA	PTUE 2 3/16" AH 01

Figure MU 26

Standard Duty Take - Up Units - Cast Housing
Eccentric Locking Collar Type, Set Screws Type

2.2500 in	ID	57.15 mm
5.1181 in	SH	130.00 mm
0.8661 in	SW	22.00 mm

Group No. OT 0200 - 1

SLB	UCT 212 - 36
ASAHI	UCT 212 - 36
FYH	UCT 212 - 36
NACHI	UCT 212 - 36
NSK	UCT 212 - 36 S
NTN	UCT 212 - 204 D 1

Group No. OT 0200 - 2

SLB	UELST 212 - 36
NTN	UELST 212 - 204 D 1 W 3

Figure MU 25

Standard Duty Take - Up Units - Cast Housing
Set Screws Type

2.2500 in	ID	57.15 mm
5.1181 in	SH	130.00 mm
1.0630 in	SW	27.00 mm

Group No. OT 0201 - 1

SLB	UCST 212 - 36
ASAHI	UCST 212 - 36

LINK BELT	TH 3 - U 236 N
RHP	ST 2 1/4
SEALMASTER	ST - 36

Group No. OT 0201 - 2

SLB	UELST 212 - 36
FAFNIR	RTU - 2 - 1/4
RHP	ST 2 1/4 DEC

Figure MU 26

Standard Duty Take - Up Units - Cast Housing
Eccentric Locking Collar Type, Set Screws Type

2.3125 in	ID	58.74 mm
5.1181 in	SH	130.00 mm
0.8661 in	SW	22.00 mm

Group No. OT 0202 - 1

SLB	UCT 212 - 37
NTN	UCT 212 - 205 D 1

Group No. OT 0202 - 2

SLB	UELST 212 - 37
NTN	UELST 212 - 205 D 1 W 3

Figure MU 25

Standard Duty Take - Up Units - Cast Housing
Set Screws Type

2.3125 in	ID	58.74 mm
5.1181 in	SH	130.00 mm
1.0630 in	SW	27.00 mm

Group No. OT 0203 - 1

SLB	UCST 212 - 37
FYH	UCST 212 - 37

Group No. OT 0203 - 2

SLB	UELST 212 - 37
FAFNIR	RTU - 2 - 5/16

Figure MU 26

Standard Duty Take - Up Units - Cast Housing
Eccentric Locking Collar Type, Set Screws Type

2.3622 in	ID	60.00 mm
5.1181 in	SH	130.00 mm
0.8661 in	SW	22.00 mm

Group No. OT 0204 - 1

SLB	UCT 212
ASAHI	UCT 212
FYH	UCT 212
INA	RTUY 60
NACHI	UCT 212
NSK	UCT 212
NTN	UCT 212 D 1

Group No. OT 0204 - 2

SLB	UELST 212
INA	RTUE 60 AH 01
NSK	EWT 212
NTN	UELST 212 D 1 W 3

Figure MU 25

Standard Duty Take - Up Units - Cast Housing
Set Screws Type

2.3622 in	ID	60.00 mm
5.1181 in	SH	130.00 mm
1.0630 in	SW	27.00 mm

Group No. OT 0205 - 1

SLB	UCST 212
ASAHI	UCST 212
RHP	ST 60
SEALMASTER	ST - 212
SNR	ST 60

Group No. OT 0205 - 2

SLB	UELST 212
FAFNIR	RTU - 60
RHP	ST 60 DEC

Figure MU 28

Standard Duty Take - Up Units - Cast Housing
Adapter Type

2.3622 in	ID	60.00 mm
5.9449 in	SH	151.00 mm
1.0236 in	SW	26.00 mm

Group No. OT 0206 - 1

SLB	UKT 213
FYH	UKT 213
NACHI	UKT 213
NSK	UKT 213
NTN	UKT 213 D 1

Figure MU 26

Standard Duty Take - Up Units - Cast Housing
Eccentric Locking Collar Type, Set Screws Type

2.3750 in	ID	60.33 mm
5.1181 in	SH	130.00 mm
0.8661 in	SW	22.00 mm

Group No. OT 0207 - 1

SLB	UCT 212 - 38
ASAHI	UCT 212 - 38
FYH	UCT 212 - 38
NACHI	UCT 212 - 38
NSK	UCT 212 - 38 S
NTN	UCT 212 - 206 D 1

Group No. OT 0207 - 2

SLB	UELST 212 - 38
NTN	UELST 212 - 206 D 1 W 3

Figure MU 25

Standard Duty Take - Up Units - Cast Housing
Set Screws Type

2.3750 in	ID	60.33 mm
5.1181 in	SH	130.00 mm
1.0630 in	SW	27.00 mm

Group No. OT 0208 - 1

SLB	UCST 212 - 38
ASAHI	UCST 212 - 38
LINK BELT	TH 3 - U 238 N
RHP	ST 2 3/8
SEALMASTER	ST - 38

Group No. OT 0208 - 2

SLB	UELST 212 - 38
FAFNIR	RTU - 2 - 3/8
RHP	ST 2 3/8 DEC

Figure MU 26

Standard Duty Take - Up Units - Cast Housing
Eccentric Locking Collar Type, Set Screws Type

2.4375 in	ID	61.91 mm
5.1181 in	SH	130.00 mm
0.8661 in	SW	22.00 mm

Group No. OT 0209 - 1

SLB	UCT 212 - 39
ASAHI	UCT 212 - 39
FYH	UCT 212 - 39
INA	RTUY 2 7/16"
NACHI	UCT 212 - 39
NTN	UCT 212 - 207 D 1

Group No. OT 0209 - 2

SLB	UELST 212 - 39
INA	RTUE 2 7/16" AH 01
NTN	UELST 212 - 207 D 1 W 3

Figure MU 25

Standard Duty Take - Up Units - Cast Housing
Set Screws Type

2.4375 in	ID	61.91 mm
5.1181 in	SH	130.00 mm
1.0630 in	SW	27.00 mm

Group No. OT 0210 - 1

SLB	UCST 212 - 39
ASAHI	UCST 212 - 39

BROWNING	VTWS - 239
LINK BELT	TH 3 - U 239 N
RHP	ST 2 7/16
SEALMASTER	ST - 39

Group No. OT 0210 - 2

SLB	UELST 212 - 39
BROWNING	VTWE - 239
FAFNIR	RTU - 2 - 7/16
RHP	ST 2 7/16 DEC

Figure MU 26

Standard Duty Take - Up Units - Cast Housing
Eccentric Locking Collar Type, Set Screws Type

2.5000 in	ID	63.50 mm
5.9449 in	SH	151.00 mm
1.0236 in	SW	26.00 mm

Group No. OT 0211 - 1

SLB	UCT 213 - 40
ASAHI	UCT 213 - 40
FYH	UCT 213 - 40
NACHI	UCT 213 - 40
NSK	UCT 213 - 40 S
NTN	UCT 213 - 208 D 1

Group No. OT 0211 - 2

SLB	UELST 213 - 40
NTN	UELST 213 - 208 D 1 W 3

Figure MU 25

Standard Duty Take - Up Units - Cast Housing
Set Screws Type

2.5000 in	ID	63.50 mm
5.9449 in	SH	151.00 mm
1.0630 in	SW	27.00 mm

Group No. OT 0212 - 1

SLB	UCST 213 - 40
ASAHI	UCST 213 - 40
RHP	ST 2 1/2
SEALMASTER	ST - 40

Group No. OT 0212 - 2

SLB	UELST 213 - 40
RHP	ST 2 1/2 DEC

Figure MU 26

Standard Duty Take - Up Units - Cast Housing
Eccentric Locking Collar Type, Set Screws Type

2.5591 in	ID	65.00 mm
5.9449 in	SH	151.00 mm
1.0236 in	SW	26.00 mm

Group No. OT 0213 - 1

SLB	UCT 213
ASAHI	UCT 213
FYH	UCT 213
NACHI	UCT 213
NSK	UCT 213
NTN	UCT 213 D 1

Group No. OT 0213 - 2

SLB	UELST 213
NSK	EWT 213
NTN	UELST 213 D 1 W 3

Figure MU 25

Standard Duty Take - Up Units - Cast Housing
Set Screws Type

2.5591 in	ID	65.00 mm
5.9449 in	SH	151.00 mm
1.0630 in	SW	27.00 mm

Group No. OT 0214 - 1

SLB	UCST 213
ASAHI	UCST 213
RHP	ST 65

Group No. OT 0214 - 2

SLB	UELST 213
RHP	ST 65 DECC

Figure MU 26

Standard Duty Take - Up Units - Cast Housing
Eccentric Locking Collar Type, Set Screws Type

2.5625 in	ID	65.09 mm
5.9449 in	SH	151.00 mm
1.0236 in	SW	26.00 mm

Group No. OT 0215 - 1

SLB	UCT 213 - 41
NTN	UCT 213 - 209 D 1

Group No. OT 0215 - 2

SLB	UELST 213 - 41
NTN	UELST 213 - 209 D 1 W 3

Figure MU 25

Standard Duty Take - Up Units - Cast Housing
Set Screws Type

2.5625 in	ID	65.09 mm
5.9449 in	SH	151.00 mm
1.0630 in	SW	27.00 mm

Group No. OT 0216 - 1

SLB	UCST 213 - 41
FYH	UCST 213 - 41

Figure MU 26

Standard Duty Take - Up Units - Cast Housing
Eccentric Locking Collar Type, Set Screws Type

2.6250 in	ID	66.68 mm
5.9449 in	SH	151.00 mm
1.0236 in	SW	26.00 mm

Group No. OT 0217 - 1

SLB	UCT 214 - 42
NTN	UCT 214 - 210 D 1

Group No. OT 0217 - 2

SLB	UELST 214 - 42
NTN	UELST 214 - 210 D 1 W 3

Figure MU 25

Standard Duty Take - Up Units - Cast Housing
Set Screws Type

2.6250 in	ID	66.68 mm
5.9449 in	SH	151.00 mm
1.0630 in	SW	27.00 mm

Group No. OT 0218 - 1

SLB	UCST 214 - 42
FYH	UCST 214 - 42

Figure MU 26

Standard Duty Take - Up Units - Cast Housing
Eccentric Locking Collar Type, Set Screws Type

2.6875 in	ID	68.26 mm
5.9449 in	SH	151.00 mm
1.0236 in	SW	26.00 mm

Group No. OT 0219 - 1

SLB	UCT 214 - 43
NTN	UCT 214 - 211 D 1

Group No. OT 0219 - 2

SLB	UELST 214 - 43
NTN	UELST 214 - 211 D 1 W 3

Figure MU 25

Standard Duty Take - Up Units - Cast Housing
Set Screws Type

2.6875 in	ID	68.26 mm
5.9449 in	SH	151.00 mm
1.0630 in	SW	27.00 mm

Group No. OT 0220 - 1

SLB	UCST 214 - 43
RHP	ST 2 11/16
SEALMASTER	ST - 43

Group No. OT 0220 - 2	
SLB	UELST 214 - 43
RHP	ST 2 11/16 DEC

Figure MU 26 
Standard Duty Take - Up Units - Cast Housing
Eccentric Locking Collar Type, Set Screws Type

2.7500 in	ID	69.85 mm
5.9449 in	SH	151.00 mm
1.0236 in	SW	26.00 mm

Group No. OT 0221 - 1	
SLB	UCT 214 - 44
ASAHI	UCT 214 - 44
FYH	UCT 214 - 44
NACHI	UCT 214 - 44
NSK	UCT 214 - 44 S
NTN	UCT 214 - 212 D 1

Group No. OT 0221 - 2	
SLB	UELST 214 - 44
NTN	UELST 214 - 212 D 1 W 3

Figure MU 25 
Standard Duty Take - Up Units - Cast Housing
Set Screws Type

2.7500 in	ID	69.85 mm
5.9449 in	SH	151.00 mm
1.0630 in	SW	27.00 mm

Group No. OT 0222 - 1	
SLB	UCST 214 - 44
RHP	ST 2 3/4

Group No. OT 0222 - 2	
SLB	UELST 214 - 44
RHP	ST 2 3/4 DEC

Figure MU 26 
Standard Duty Take - Up Units - Cast Housing
Eccentric Locking Collar Type, Set Screws Type

2.7559 in	ID	70.00 mm
5.9449 in	SH	151.00 mm
1.0236 in	SW	26.00 mm

Group No. OT 0223 - 1	
SLB	UCT 214
ASAHI	UCT 214
FYH	UCT 214
INA	RTUY 70
NACHI	UCT 214
NSK	UCT 214
NTN	UCT 214 D 1

Group No. OT 0223 - 2	
SLB	UELST 214
INA	RTUE 70 S AH 01
NTN	UELST 214 D 1 W 3

Figure MU 25 
Standard Duty Take - Up Units - Cast Housing
Set Screws Type

2.7559 in	ID	70.00 mm
5.9449 in	SH	151.00 mm
1.0630 in	SW	27.00 mm

Group No. OT 0224 - 1	
SLB	UCST 214
RHP	ST 70
SEALMASTER	ST - 214

Group No. OT 0224 - 2	
SLB	UELST 214
RHP	ST 70 DEC

Figure MU 26 
Standard Duty Take - Up Units - Cast Housing
Eccentric Locking Collar Type, Set Screws Type

2.8125 in	ID	71.44 mm
5.9449 in	SH	151.00 mm
1.0236 in	SW	26.00 mm

Group No. OT 0225 - 1	
SLB	UCT 215 - 45
NTN	UCT 215 - 213 D 1

Group No. OT 0225 - 2	
SLB	UELST 215 - 45
NTN	UELST 215 - 213 D 1 W 3

Figure MU 25 
Standard Duty Take - Up Units - Cast Housing
Set Screws Type

2.8125 in	ID	71.44 mm
5.9449 in	SH	151.00 mm
1.0630 in	SW	27.00 mm

Group No. OT 0226 - 1	
SLB	UCST 215 - 45
FYH	UCST 215 - 45

Figure MU 26 
Standard Duty Take - Up Units - Cast Housing
Eccentric Locking Collar Type, Set Screws Type

2.8750 in	ID	73.03 mm
5.9449 in	SH	151.00 mm
1.0236 in	SW	26.00 mm

Group No. OT 0227 - 1	
SLB	UCT 215 - 46
NTN	UCT 215 - 214 D 1

Group No. OT 0227 - 2	
SLB	UELST 215 - 46
NTN	UELST 215 - 214 D 1 W 3

Figure MU 25 
Standard Duty Take - Up Units - Cast Housing
Set Screws Type

2.8750 in	ID	73.03 mm
5.9449 in	SH	151.00 mm
1.0630 in	SW	27.00 mm

Group No. OT 0228 - 1	
SLB	UCST 215 - 46
RHP	ST 2 7/8
SEALMASTER	ST - 46

Group No. OT 0228 - 2	
SLB	UELST 215 - 46
RHP	ST 2 7/8 DEC

Figure MU 26 
Standard Duty Take - Up Units - Cast Housing
Eccentric Locking Collar Type, Set Screws Type

2.9375 in	ID	74.61 mm
5.9449 in	SH	151.00 mm
1.0236 in	SW	26.00 mm

Group No. OT 0229 - 1	
SLB	UCT 215 - 47
INA	RTUY 2 15/16"
NTN	UCT 215 - 215 D 1

Group No. OT 0229 - 2	
SLB	UELST 215 - 47
INA	RTUE 2 15/16" SAH 01
NTN	UELST 215 - 215 D 1 W 3

Figure MU 25 
Standard Duty Take - Up Units - Cast Housing
Set Screws Type

2.9375 in	ID	74.61 mm
5.9449 in	SH	151.00 mm
1.0630 in	SW	27.00 mm

Group No. OT 0230 - 1	
SLB	UCST 215 - 47
RHP	ST 2 15/16
SEALMASTER	ST - 47

Group No. OT 0230 - 2	
SLB	UELST 215 - 47
RHP	ST 2 15/16 DEC

Figure MU 26 
Standard Duty Take - Up Units - Cast Housing
Eccentric Locking Collar Type, Set Screws Type

2.9528 in	ID	75.00 mm
5.9449 in	SH	151.00 mm
1.0236 in	SW	26.00 mm

Group No. OT 0231 - 1

SLB	UCT 215
ASAHI	UCT 215
FYH	UCT 215
INA	RTUY 75
NACHI	UCT 215
NSK	UCT 215
NTN	UCT 215 D 1

Group No. OT 0231 - 2

SLB	UEL215
INA	RTUE 75 SAH 01
NTN	UEL215 D 1 W 3

Figure MU 25 
Standard Duty Take - Up Units - Cast Housing
Set Screws Type

2.9528 in	ID	75.00 mm
5.9449 in	SH	151.00 mm
1.0630 in	SW	27.00 mm

Group No. OT 0232 - 1

SLB	UCST 215
RHP	ST 75
SEALMASTER	ST - 215

Figure MU 26 
Standard Duty Take - Up Units - Cast Housing
Eccentric Locking Collar Type, Set Screws Type

3.0000 in	ID	76.20 mm
5.9449 in	SH	151.00 mm
1.0236 in	SW	26.00 mm

Group No. OT 0233 - 1

SLB	UCT 215 - 48
ASAHI	UCT 215 - 48
FYH	UCT 215 - 48
NACHI	UCT 215 - 48
NSK	UCT 215 - 48 S
NTN	UCT 215 - 300 D 1

Group No. OT 0233 - 2

SLB	UEL215 - 48
NTN	UEL215 - 300 D 1 W 3

Figure MU 25 
Standard Duty Take - Up Units - Cast Housing
Set Screws Type

3.0000 in	ID	76.20 mm
5.9449 in	SH	151.00 mm
1.0630 in	SW	27.00 mm

Group No. OT 0234 - 1

SLB	UCST 215 - 48
RHP	ST 3

Figure MU 26 
Standard Duty Take - Up Units - Cast Housing
Eccentric Locking Collar Type, Set Screws Type

3.0625 in	ID	77.79 mm
6.4961 in	SH	165.00 mm
1.0236 in	SW	26.00 mm

Group No. OT 0235 - 1

SLB	UCT 216 - 49
NTN	UCT 216 - 301 D 1

Figure MU 26 
Standard Duty Take - Up Units - Cast Housing
Eccentric Locking Collar Type, Set Screws Type

3.1250 in	ID	79.38 mm
6.4961 in	SH	165.00 mm
1.0236 in	SW	26.00 mm

Group No. OT 0236 - 1

SLB	UCT 216 - 50
ASAHI	UCT 216 - 50
NACHI	UCT 216 - 50
NSK	UCT 216 - 50 S
NTN	UCT 216 - 302 D 1

Figure MU 26 
Standard Duty Take - Up Units - Cast Housing
Eccentric Locking Collar Type, Set Screws Type

3.1496 in	ID	80.00 mm
6.4961 in	SH	165.00 mm
1.0236 in	SW	26.00 mm

Group No. OT 0237 - 1

SLB	UCT 216
ASAHI	UCT 216
FYH	UCT 216
NACHI	UCT 216
NSK	UCT 216
NTN	UCT 216 D 1

Figure MU 26 
Standard Duty Take - Up Units - Cast Housing
Eccentric Locking Collar Type, Set Screws Type

3.1875 in	ID	80.96 mm
6.4961 in	SH	165.00 mm
1.0236 in	SW	26.00 mm

Group No. OT 0238 - 1

SLB	UCT 216 - 51
NTN	UCT 216 - 303 D 1

Figure MU 26 
Standard Duty Take - Up Units - Cast Housing
Eccentric Locking Collar Type, Set Screws Type

3.2500 in	ID	82.55 mm
6.8110 in	SH	173.00 mm
1.1811 in	SW	30.00 mm

Group No. OT 0239 - 1

SLB	UCT 217 - 52
ASAHI	UCT 217 - 52
FYH	UCT 217 - 52
NACHI	UCT 217 - 52
NSK	UCT 217 - 52 S
NTN	UCT 217 - 304 D 1

Figure MU 26 
Standard Duty Take - Up Units - Cast Housing
Eccentric Locking Collar Type, Set Screws Type

3.3125 in	ID	84.14 mm
6.8110 in	SH	173.00 mm
1.1811 in	SW	30.00 mm

Group No. OT 0240 - 1

SLB	UCT 217 - 53
NTN	UCT 217 - 305 D 1

Figure MU 26 
Standard Duty Take - Up Units - Cast Housing
Eccentric Locking Collar Type, Set Screws Type

3.3465 in	ID	85.00 mm
6.8110 in	SH	173.00 mm
1.1811 in	SW	30.00 mm

Group No. OT 0241 - 1

SLB	UCT 217
ASAHI	UCT 217
FYH	UCT 217
NACHI	UCT 217
NSK	UCT 217
NTN	UCT 217 D 1

Figure MU 26 
Standard Duty Take - Up Units - Cast Housing
Eccentric Locking Collar Type, Set Screws Type

3.4375 in	ID	87.31 mm
6.8110 in	SH	173.00 mm
1.1811 in	SW	30.00 mm

Group No. OT 0242 - 1

SLB	UCT 217 - 55
NSK	UCT 217 - 55 D 1
NTN	UCT 217 - 307 D 1

Figure MU 30
Standard Duty Spherical Outside Surface Ball Bearings
Set Screws Type

0.4724 in	ID	12.00 mm
1.5748 in	OD	40.00 mm
0.8661 in	IW	22.00 mm

Group No. IB 0001 - 1

SLB	SB 201
ASAHI	B 1
FYH	SB 201
INA	GAY 12 NPPB
NACHI	B 1
NSK	UB 201
NTN	AS 201

Figure MU 31
Standard Duty Spherical Outside Surface Ball Bearings
Set Screws Type

0.4724 in	ID	12.00 mm
1.8504 in	OD	47.00 mm
1.2205 in	IW	31.00 mm

Group No. IB 0002 - 1

SLB	UC 201
ASAHI	UC 201
FYH	UC 201
NACHI	UC 201
NSK	UC 201
NTN	UC 201 D 1

Figure MU 29
Standard Duty Spherical Outside Surface Ball Bearings
Eccentric Locking Collar Type

0.4724 in	ID	12.00 mm
1.5748 in	OD	40.00 mm
1.1220 in	IW	28.50 mm

Group No. IB 0003 - 1

SLB	SA 201
ASAHI	KH 201 AE
FYH	SA 201
INA	GRAE 12 NPPB
NACHI	KH 201 AE
NSK	EN 201
NTN	AEL 201 W 3
RHP	1217 - 12 ECG
SKF	YET 203/12

Figure MU 34
Standard Duty Spherical Outside Surface Ball Bearings
Eccentric Locking Collar Type

0.4724 in	ID	12.00 mm
1.8504 in	OD	47.00 mm
1.7126 in	IW	43.50 mm

Group No. IB 0004 - 1

SLB	UEL 201
FYH	NA 201

Figure MU 30
Standard Duty Spherical Outside Surface Ball Bearings
Set Screws Type

0.5000 in	ID	12.70 mm
1.5748 in	OD	40.00 mm
0.8661 in	IW	22.00 mm

Group No. IB 0005 - 1

SLB	SB 201 - 8
ASAHI	B 1 - 8
FYH	SB 201 - 8
INA	GAY 008 NPPB
NACHI	B 1 - 8
NSK	UB 201 - 8 S
NTN	AS 201 - 008

Figure MU 31
Standard Duty Spherical Outside Surface Ball Bearings
Set Screws Type

0.5000 in	ID	12.70 mm
1.8504 in	OD	47.00 mm
1.2205 in	IW	31.00 mm

Group No. IB 0006 - 1

SLB	UC 201 - 8
ASAHI	UC 201 - 8
FYH	UC 201 - 8
NACHI	UC 201 - 8
NSK	UC 201 - 8 S
NTN	UC 201 - 008 D 1
SEALMASTER	2000 - 2 - 8

Figure MU 29
Standard Duty Spherical Outside Surface Ball Bearings
Eccentric Locking Collar Type

0.5000 in	ID	12.70 mm
1.5748 in	OD	40.00 mm
1.1220 in	IW	28.50 mm

Group No. IB 0007 - 1

SLB	SA 201 - 8
ASAHI	KH 201 - 8 AE
BROWNING	VE - 108
FAFNIR	GRA 008 RRB
FYH	SA 201 - 8
INA	GRA 008 NPPB
LINK - BELT	WG 2 B 08 UL
NACHI	KH 201 - 8 AE
NSK	EN 201 - 8 S

NTN	AEL 201 - 008 W 3
RHP	1217 - 1/2 ECG
SEALMASTER	V - 8 E
SKF	YET 203 - 008

Figure MU 34
Standard Duty Spherical Outside Surface Ball Bearings
Eccentric Locking Collar Type

0.5000 in	ID	12.70 mm
1.8504 in	OD	47.00 mm
1.7126 in	IW	43.50 mm

Group No. IB 0008 - 1

SLB	UEL 201 - 8
FYH	NA 201 - 8

Figure MU 30
Standard Duty Spherical Outside Surface Ball Bearings
Set Screws Type

0.5625 in	ID	14.29 mm
1.5748 in	OD	40.00 mm
0.8661 in	IW	22.00 mm

Group No. IB 0009 - 1

SLB	SB 202 - 9
ASAHI	B 2 - 9
NACHI	B 2 - 9
NSK	UB 202 - 9 S
NTN	AS 202 - 009

Figure MU 31
Standard Duty Spherical Outside Surface Ball Bearings
Set Screws Type

0.5625 in	ID	14.29 mm
1.8504 in	OD	47.00 mm
1.2205 in	IW	31.00 mm

Group No. IB 0010 - 1

SLB	UC 202 - 9
ASAHI	UC 202 - 9
NACHI	UC 202 - 9
NSK	UC 202 - 9 S
NTN	UC 202 - 009 D 1
SEALMASTER	2000 - 2 - 9

Figure MU 29
Standard Duty Spherical Outside Surface Ball Bearings
Eccentric Locking Collar Type

0.5625 in	ID	14.29 mm
1.5748 in	OD	40.00 mm
1.1220 in	IW	28.50 mm

Group No. IB 0011 - 1		
SLB	SA 202 - 9	
ASAHI	KH 202 - 9 AE	
FAFNIR	GR A009 RRB	
NACHI	KH 202 - 9 AE	
NSK	EN 202 - 9 S	
NTN	AEL 202 - 009 W 3	

Figure MU 34
Standard Duty Spherical Outside Surface Ball Bearings
Eccentric Locking Collar Type

0.5625 in	ID	14.29 mm
1.8504 in	OD	47.00 mm
1.7126 in	IW	43.50 mm

Group No. IB 0012 - 1		
SLB	UEL 202 - 9	
FYH	UEL 202 - 9	

Figure MU 30
Standard Duty Spherical Outside Surface Ball Bearings
Set Screws Type

0.5906 in	ID	15.00 mm
1.5748 in	OD	40.00 mm
0.8661 in	IW	22.00 mm

Group No. IB 0013 - 1		
SLB	SB 202	
ASAHI	B 2	
FYH	SB 202	
INA	GAY 15 NPPB	
NACHI	B 2	
NSK	UB 202	
NTN	AS 202	

Figure MU 31
Standard Duty Spherical Outside Surface Ball Bearings
Set Screws Type

0.5906 in	ID	15.00 mm
1.8504 in	OD	47.00 mm
1.2205 in	IW	31.00 mm

Group No. IB 0014 - 1		
SLB	UC 202	
ASAHI	UC 202	
FYH	UC 202	
NACHI	UC 202	
NSK	UC 202	
NTN	UC 202 D 1	

Figure MU 29
Standard Duty Spherical Outside Surface Ball Bearings
Eccentric Locking Collar Type

0.5906 in	ID	15.00 mm
1.5748 in	OD	40.00 mm
1.1220 in	IW	28.50 mm

Group No. IB 0015 - 1		
SLB	SA 202	
ASAHI	KH 202 AE	
FAG	16203/15	
FYH	SA 202	
INA	GRAE 15 NPPB	
NACHI	KH 202 AE	
NSK	EN 202	
NTN	AEL 202 W 3	
RHP	1217 - 15 ECG	
SKF	YET 203/15	

Figure MU 34
Standard Duty Spherical Outside Surface Ball Bearings
Eccentric Locking Collar Type

0.5906 in	ID	15.00 mm
1.8504 in	OD	47.00 mm
1.7126 in	IW	43.50 mm

Group No. IB 0016 - 1		
SLB	UEL 202	
FYH	NA 202	

Figure MU 30
Standard Duty Spherical Outside Surface Ball Bearings
Set Screws Type

0.6250 in	ID	15.88 mm
1.5748 in	OD	40.00 mm
0.8661 in	IW	22.00 mm

Group No. IB 0017 - 1		
SLB	SB 202 - 10	
ASAHI	B 2 - 10	
FYH	SB 202 - 10	
INA	GAY 010 NPPB	
KOYO	PB 10	
NACHI	B 2 - 10	
NSK	UB 202 - 10 S	
NTN	AS 202 - 010	

Figure MU 31
Standard Duty Spherical Outside Surface Ball Bearings
Set Screws Type

0.6250 in	ID	15.88 mm
1.8504 in	OD	47.00 mm
1.2205 in	IW	31.00 mm

Group No. IB 0018 - 1		
SLB	UC 202 - 10	
ASAHI	UC 202 - 10	
FYH	UC 202 - 10	

NACHI	UC 202 - 10
NSK	UC 202 - 10 S
NTN	UC 202 - 010 D 1
SEALMASTER	2 - 010

Figure MU 29
Standard Duty Spherical Outside Surface Ball Bearings
Eccentric Locking Collar Type

0.6250 in	ID	15.88 mm
1.5748 in	OD	40.00 mm
1.1220 in	IW	28.50 mm

Group No. IB 0019 - 1		
SLB	SA 202 - 10	
ASAHI	KH 202 - 10 AE	
BROWNING	VE - 110	
FAFNIR	GRA 010 RRB	
FYH	SA 202 - 10	
INA	GRA 010 NPPB	
KOYO	GARA 010 2 RSA	
LINK - BELT	WG 210 UL	
NACHI	KH 202 - 10 AE	
NSK	EN 202 - 10 S	
NTN	AEL 202 - 010 W 3	
RHP	1217 - 5/8 ECG	
SEALMASTER	V - 10 E	
SKF	YET 203 - 010	

Figure MU 34
Standard Duty Spherical Outside Surface Ball Bearings
Eccentric Locking Collar Type

0.6250 in	ID	15.88 mm
1.8504 in	OD	47.00 mm
1.7126 in	IW	43.50 mm

Group No. IB 0020 - 1		
SLB	UEL 202 - 10	
FYH	NA 202 - 10	

Figure MU 30
Standard Duty Spherical Outside Surface Ball Bearings
Set Screws Type

0.6693 in	ID	17.00 mm
1.5748 in	OD	40.00 mm
0.8661 in	IW	22.00 mm

Group No. IB 0021 - 1		
SLB	SB 203	
ASAHI	B 3	
FYH	SB 203	
INA	GAY 17 NPPB	
KOYO	PB 11 M	
NACHI	B 3	
NSK	UB 203	
NTN	AS 203	

Figure MU 31
Standard Duty Spherical Outside Surface Ball Bearings
Set Screws Type

0.6693 in	ID	17.00 mm
1.8504 in	OD	47.00 mm
1.2205 in	IW	31.00 mm

Group No. IB 0022 - 1

SLB	UC 203
ASAHI	UC 203
FYH	UC 203
NACHI	UC 203
NSK	UC 203
NTN	UC 203 D 1

Figure MU 29
Standard Duty Spherical Outside Surface Ball Bearings
Eccentric Locking Collar Type

0.6693 in	ID	17.00 mm
1.5748 in	OD	40.00 mm
1.1220 in	IW	28.50 mm

Group No. IB 0023 - 1

SLB	SA 203
ASAHI	KH 203 AE
FAFNIR	GRAE 17 RRB
FAG	16203
FYH	SA 203
INA	GRAE 17 NPPB
NACHI	KH 203 AE
NSK	EN 203
NTN	AEL 203 W 3
RHP	1217 - 17 ECG
SKF	YET 203
SNR	1217 - 17 ECG

Figure MU 34
Standard Duty Spherical Outside Surface Ball Bearings
Eccentric Locking Collar Type

0.6693 in	ID	17.00 mm
1.8504 in	OD	47.00 mm
1.7126 in	IW	43.50 mm

Group No. IB 0024 - 1

SLB	UEL 203
FYH	NA 203

Figure MU 30
Standard Duty Spherical Outside Surface Ball Bearings
Set Screws Type

0.6875 in	ID	17.46 mm
1.5748 in	OD	40.00 mm
0.8661 in	IW	22.00 mm

Group No. IB 0025 - 1

SLB	SB 203 - 11
ASAHI	B 3 - 11
KOYO	PB 11
NACHI	B 3 - 11
NSK	UB 203 - 11 S
NTN	AS 203 - 011

Figure MU 31
Standard Duty Spherical Outside Surface Ball Bearings
Set Screws Type

0.6875 in	ID	17.46 mm
1.8504 in	OD	47.00 mm
1.2205 in	IW	31.00 mm

Group No. IB 0026 - 1

SLB	UC 203 - 11
ASAHI	UC 203 - 11
NACHI	UC 203 - 11
NSK	UC 203 - 11 S
NTN	UC 203 - 011 D 1
SEALMASTER	2 - 011

Figure MU 29
Standard Duty Spherical Outside Surface Ball Bearings
Eccentric Locking Collar Type

0.6875 in	ID	17.46 mm
1.5748 in	OD	40.00 mm
1.1220 in	IW	28.50 mm

Group No. IB 0027 - 1

SLB	SA 203 - 11
ASAHI	KH 203 - 11 AE
LINK - BELT	WG 211 UL
NACHI	KH 203 - 11 AE
NSK	EN 203 - 11 S
NTN	AEL 203 - 011 W 3
SKF	YET 203 - 011

Figure MU 34
Standard Duty Spherical Outside Surface Ball Bearings
Eccentric Locking Collar Type

0.6875 in	ID	17.46 mm
1.8504 in	OD	47.00 mm
1.7126 in	IW	43.50 mm

Group No. IB 0028 - 1

SLB	UEL 203 - 11
FYH	UEL 203 - 11

Figure MU 30
Standard Duty Spherical Outside Surface Ball Bearings
Set Screws Type

0.7500 in	ID	19.05 mm
1.8504 in	OD	47.00 mm
0.9843 in	IW	25.00 mm

Group No. IB 0029 - 1

SLB	SB 204 - 12
ASAHI	B 4 - 12
FYH	SB 204 - 12
INA	GAY 012 NPPB
KOYO	PB 12
NACHI	B 4 - 12
NSK	UB 204 - 12 S
NTN	AS 204 - 012
RHP	1220 - 3/4 G

Figure MU 31
Standard Duty Spherical Outside Surface Ball Bearings
Set Screws Type

0.7500 in	ID	19.05 mm
1.8504 in	OD	47.00 mm
1.2205 in	IW	31.00 mm

Group No. IB 0030 - 1

SLB	UC 204 - 12
ASAHI	UC 204 - 12
BROWNING	VS - 212
FAG	56204.012
FYH	UC 204 - 12
INA	GY 1012 KRRB
KOYO	UC 204 - 12
LINK - BELT	UG 212 NL
NACHI	UC 204 - 12
NSK	UC 204 - 12 S
NTN	UC 204 - 012 D 1
RHP	1020 - 3/4 G
SEALMASTER	2 - 012
SKF	YAR 204 - 012

Figure MU 29
Standard Duty Spherical Outside Surface Ball Bearings
Eccentric Locking Collar Type

0.7500 in	ID	19.05 mm
1.8504 in	OD	47.00 mm
1.1614 in	IW	29.50 mm

Group No. IB 0031 - 1

SLB	SA 204 - 12
ASAHI	KH 204 - 12 AE
FAFNIR	GRA 012 RRB
FAG	16204.012
FYH	SA 204 - 12
INA	GRA 012 NPPB
KOYO	GARA 012.2 RSA
LINK - BELT	WG 212 UL
NACHI	KH 204 - 12 AE

NSK	EN 204 - 12 S
NTN	AEL 204 - 012 W 3
RHP	1220 - 3/4 ECG
SKF	YET 204 - 012

Figure MU 34

Standard Duty Spherical Outside Surface Ball Bearings
Eccentric Locking Collar Type

0.7500 in	ID	19.05 mm
1.8504 in	OD	47.00 mm
1.7126 in	IW	43.50 mm

Group No. IB 0032 - 1

SLB	UEL 204 - 12
ASAHI	UG 204 - 12 + ER
BROWNING	VE - 212
FAFNIR	G 1012 KRRB
FYH	NA 204 - 12
INA	G 1012 KRRB
KOYO	GA 1012 2 RSB
LINK - BELT	YG 212 NL
NACHI	UG 204 - 12 + ER
NSK	EW 204 - 12 S
NTN	UEL 204 - 012 D 1 W 3
RHP	1020 - 3/4 DECG
SKF	YEL 204 - 012

Figure MU 30

Standard Duty Spherical Outside Surface Ball Bearings
Set Screws Type

0.7874 in	ID	20.00 mm
1.8504 in	OD	47.00 mm
0.9843 in	IW	25.00 mm

Group No. IB 0033 - 1

SLB	SB 204
ASAHI	B 4
FYH	SB 204
INA	GAY 20 NPPB
KOYO	PB 12 M
NACHI	B 4
NSK	UB 204
NTN	AS 204
RHP	1220 - 20 G
SNR	1220 - 20 G

Figure MU 31

Standard Duty Spherical Outside Surface Ball Bearings
Set Screws Type

0.7874 in	ID	20.00 mm
1.8504 in	OD	47.00 mm
1.2205 in	IW	31.00 mm

Group No. IB 0034 - 1

SLB	UC 204
ASAHI	UC 204
FAG	56204
FYH	UC 204
INA	GYE 20 KRRB
KOYO	UC 204
LINK - BELT	UG 2 M 20 NL
NACHI	UC 204
NSK	UC 204
NTN	UC 204 D 1
RHP	1020 - 20 G
SEALMASTER	5204
SKF	YAR 204
SNR	1020 - 20 G

Figure MU 29

Standard Duty Spherical Outside Surface Ball Bearings
Eccentric Locking Collar Type

0.7874 in	ID	20.00 mm
1.8504 in	OD	47.00 mm
1.1614 in	IW	29.50 mm

Group No. IB 0035 - 1

SLB	SA 204
ASAHI	KH 204 AE
FAFNIR	GRAE 20 RRB
FAG	16204
FYH	SA 204
INA	GRAE 20 NPPB
KOYO	GARA 012 M 2 RSA
NACHI	KH 204 AE
NSK	EN 204
NTN	AEL 204 W 3
RHP	1220 - 20 ECG
SKF	YET 204
SNR	1220 - 20 ECG

Figure MU 34

Standard Duty Spherical Outside Surface Ball Bearings
Eccentric Locking Collar Type

0.7874 in	ID	20.00 mm
1.8504 in	OD	47.00 mm
1.7126 in	IW	43.50 mm

Group No. IB 0036 - 1

SLB	UEL 204
ASAHI	UG 204 + ER
FAFNIR	GE 20 KRRB
FAG	36204 B
FYH	NA 204
INA	GE 20 KRRB
KOYO	GA 1012 M 2 RSB
NACHI	UG 204 + ER
NSK	EW 204
NTN	UEL 204 D 1 W 3
RHP	1020 - 20 D ECG
SKF	YEL 204

Figure MU 35

Standard Duty Spherical Outside Surface Ball Bearings
Adapter Type

0.7874 in	ID	20.00 mm
2.0472 in	OD	52.00 mm
0.8268 in	IW	21.00 mm

Group No. IB 0037 - 1

SLB	UK 205
ASAHI	UK 205
FYH	UK 205
NACHI	UK 205
NSK	UK 205
NTN	UK 205 D 1
RHP	1025 - 20 KG

Figure MU 30

Standard Duty Spherical Outside Surface Ball Bearings
Set Screws Type

0.8125 in	ID	20.64 mm
2.0472 in	OD	52.00 mm
1.0630 in	IW	27.00 mm

Group No. IB 0038 - 1

SLB	SB 205 - 13
KOYO	PB 13
NSK	UB 205 - 13 S
NTN	AS 205 - 013

Figure MU 31

Standard Duty Spherical Outside Surface Ball Bearings
Set Screws Type

0.8125 in	ID	20.64 mm
2.0472 in	OD	52.00 mm
1.3386 in	IW	34.00 mm

Group No. IB 0039 - 1

SLB	UC 205 - 13
KOYO	UC 205 - 13
NSK	UC 205 - 13 S
NTN	UC 205 - 013 D 1
SEALMASTER	2 - 013
SKF	YAR 205 - 013

Figure MU 29

Standard Duty Spherical Outside Surface Ball Bearings
Eccentric Locking Collar Type

0.8125 in	ID	20.64 mm
2.0472 in	OD	52.00 mm
1.2008 in	IW	30.50 mm

Group No. IB 0040 - 1

SLB	SA 205 - 13
FAFNIR	GRA 013 RRB

KOYO	GARA 013 2 RSA
NSK	EN 205 - 13 S
NTN	AEL 205 - 013 W 3
SKF	YET 205 - 013

Figure MU 34
Standard Duty Spherical Outside Surface Ball Bearings
Eccentric Locking Collar Type

0.8125 in	ID	20.64 mm
2.0472 in	OD	52.00 mm
1.7441 in	IW	44.30 mm

Group No. IB 0041 - 1

SLB	UEL 205 - 13
FAFNIR	G 1013 KRRB
KOYO	GA 1013 2 RSB
NSK	EW 205 - 13 S
NTN	UEL 205 - 013 D 1 W 3
SKF	YEL 205 - 013

Figure MU 33
Medium Duty Spherical Outside Surface Ball Bearings
Set Screws Type

0.8125 in	ID	20.64 mm
2.4409 in	OD	62.00 mm
1.5000 in	IW	38.10 mm

Group No. IB 0042 - 1

SLB	UC X05 - 13
NSK	UC X05 - 13 S
NTN	UC X05 - 013 D 1

Figure MU 32
Heavy Duty Spherical Outside Surface Ball Bearings
Set Screws Type

0.8125 in	ID	20.64 mm
2.4409 in	OD	62.00 mm
1.4961 in	IW	38.00 mm

Group No. IB 0043 - 1

SLB	UC 305 - 13
NSK	UC 305 - 13 S
NTN	UC 305 - 013 D 1

Figure MU 30
Standard Duty Spherical Outside Surface Ball Bearings
Set Screws Type

0.8750 in	ID	22.23 mm
2.0472 in	OD	52.00 mm
1.0630 in	IW	27.00 mm

Group No. IB 0044 - 1

SLB	SB 205 - 14
ASAHI	B 5 - 14
BROWNING	VS - 114
FAFNIR	GYA 014 RRB
FYH	SB 205 - 14
KOYO	PB 14
NACHI	B 5 - 14
NSK	UB 205 - 14 S
NTN	AS 205 - 014
SEALMASTER	V - 14

Figure MU 31
Standard Duty Spherical Outside Surface Ball Bearings
Set Screws Type

0.8750 in	ID	22.23 mm
2.0472 in	OD	52.00 mm
1.3386 in	IW	34.00 mm

Group No. IB 0045 - 1

SLB	UC 205 - 14
ASAHI	UC 205 - 14
BROWNING	VS - 214
FYH	UC 205 - 14
INA	GY 1014 KRRB
KOYO	UC 205 - 14
LINK - BELT	UG 214 NL
NACHI	UC 205 - 14
NSK	UC 205 - 14 S
NTN	UC 205 - 014 D 1
RHP	1025 - 7/8 G
SEALMASTER	2 - 014
SKF	YAR 205 - 014

Figure MU 29
Standard Duty Spherical Outside Surface Ball Bearings
Eccentric Locking Collar Type

0.8750 in	ID	22.23 mm
2.0472 in	OD	52.00 mm
1.2008 in	IW	30.50 mm

Group No. IB 0046 - 1

SLB	SA 205 - 14
ASAHI	KH 205 - 14 AE
BROWNING	VE - 114
FAFNIR	GRA 014 RRB
FAG	16205.014
FYH	SA 205 - 14
INA	GRA 014 NPPB
KOYO	GARA 014 2 RSA
LINK - BELT	WG 214 UL
NACHI	KH 205 - 14 AE
NSK	EN 205 - 14 S
NTN	AEL 205 - 014 W 3
RHP	1225 - 7/8 ECG
SEALMASTER	V - 14 E
SKF	YET 205 - 014

Figure MU 34
Standard Duty Spherical Outside Surface Ball Bearings
Eccentric Locking Collar Type

0.8750 in	ID	22.23 mm
2.0472 in	OD	52.00 mm
1.7441 in	IW	44.30 mm

Group No. IB 0047 - 1

SLB	UEL 205 - 14
ASAHI	UG 205 - 14 + ER
BROWNING	VE - 214
FAFNIR	G 1014 KRRB
FYH	NA 205 - 14
INA	G 1014 KRRB
KOYO	GA 1014 2 RSB
LINK - BELT	YG 214 NL
NACHI	UG 205 - 14 + ER
NSK	EW 205 - 14 S
NTN	UEL 205 - 014 D 1 W 3
RHP	1025 - 7/8 DECG
SKF	YEL 205 - 014

Figure MU 33
Medium Duty Spherical Outside Surface Ball Bearings
Set Screws Type

0.8750 in	ID	22.23 mm
2.4409 in	OD	62.00 mm
1.5000 in	IW	38.10 mm

Group No. IB 0048 - 1

SLB	UC X05 - 14
ASAHI	UC X05 - 14
NSK	UC X05 - 14 S
NTN	UC X05 - 014 D 1

Figure MU 32
Heavy Duty Spherical Outside Surface Ball Bearings
Set Screws Type

0.8750 in	ID	22.23 mm
2.4409 in	OD	62.00 mm
1.4961 in	IW	38.00 mm

Group No. IB 0049 - 1

SLB	UC 305 - 14
ASAHI	UC 305 - 14
NSK	UC 305 - 14 S
NTN	UC 305 - 014 D 1

Figure MU 30
Standard Duty Spherical Outside Surface Ball Bearings
Set Screws Type

0.9375 in	ID	23.81 mm
2.0472 in	OD	52.00 mm
1.0630 in	IW	27.00 mm

Group No. IB 0050 - 1		
SLB	SB 205 - 15	
ASAHI	B 5 - 15	
BROWNING	VS - 115	
FAFNIR	GYA 015 RRB	
KOYO	PB 15	
NACHI	B 5 - 15	
NSK	UB 205 - 15 S	
NTN	AS 205 - 015	
SEALMASTER	V - 15	

0.9375 in	ID	23.81 mm
2.0472 in	OD	52.00 mm
1.7441 in	IW	44.30 mm

Group No. IB 0053 - 1		
SLB	UEL 205 - 15	
ASAHI	UG 205 - 15 + ER	
BROWNING	VE - 215	
FAFNIR	G 1015 KRRB	
FYH	NA 205 - 15	
INA	G 1015 KRRB	
KOYO	GA 1015 2 RSB	
LINK - BELT	YG 215 NL	
NACHI	UG 205 - 15 + ER	
NSK	EW 205 - 15 S	
NTN	UEL 205 - 015 D 1 W 3	
RHP	1025 - 15/16 DECG	
SKF	YEL 205 - 015	

FAFNIR	GYAE 25 RRB
FYH	SB 205
INA	GAY 25 NPPB
KOYO	PB 16 M
NACHI	B 5
NSK	UB 205
NTN	AS 205
RHP	1225 - 25 G
SNR	1225 - 25 G

Figure MU 31		
<i>Standard Duty Spherical Outside Surface Ball Bearings Set Screws Type</i>		
0.9375 in	ID	23.81 mm
2.0472 in	OD	52.00 mm
1.3386 in	IW	34.00 mm

Figure MU 33		
<i>Medium Duty Spherical Outside Surface Ball Bearings Set Screws Type</i>		
0.9375 in	ID	23.81 mm
2.4409 in	OD	62.00 mm
1.5000 in	IW	38.10 mm

Figure MU 31		
<i>Standard Duty Spherical Outside Surface Ball Bearings Set Screws Type</i>		
0.9843 in	ID	25.00 mm
2.0472 in	OD	52.00 mm
1.3386 in	IW	34.00 mm

Group No. IB 0051 - 1		
SLB	UC 205 - 15	
ASAHI	UC 205 - 15	
BROWNING	VS - 215	
FYH	UC 205 - 15	
KOYO	UC 205 - 15	
LINK - BELT	UG 215 NL	
NACHI	UC 205 - 15	
NSK	UC 205 - 15 S	
NTN	UC 205 - 015 D 1	
RHP	1025 - 15/16 G	
SEALMASTER	2 - 015	
SKF	YAR 205 - 015	

Group No. IB 0054 - 1		
SLB	UC X05 - 15	
ASAHI	UC X05 - 15	
NSK	UC X05 - 15 S	
NTN	UC X05 - 015 D 1	
SEALMASTER	3 - 015	

Group No. IB 0057 - 1		
SLB	UC 205	
ASAHI	UC 205	
FAG	56205	
FYH	UC 205	
INA	GYE 25 KRRB	
KOYO	UC 205	
LINK - BELT	UG 2 M 25 NL	
NACHI	UC 205	
NSK	UC 205	
NTN	UC 205 D 1	
RHP	1025 - 25 G	
SEALMASTER	5205	
SKF	YAR 205	
SNR	1025 - 25 G	

Figure MU 29		
<i>Standard Duty Spherical Outside Surface Ball Bearings Eccentric Locking Collar Type</i>		
0.9375 in	ID	23.81 mm
2.0472 in	OD	52.00 mm
1.2008 in	IW	30.50 mm

Figure MU 32		
<i>Heavy Duty Spherical Outside Surface Ball Bearings Set Screws Type</i>		
0.9375 in	ID	23.81 mm
2.4409 in	OD	62.00 mm
1.4961 in	IW	38.00 mm

Figure MU 29		
<i>Standard Duty Spherical Outside Surface Ball Bearings Eccentric Locking Collar Type</i>		
0.9843 in	ID	25.00 mm
2.0472 in	OD	52.00 mm
1.2008 in	IW	30.50 mm

Group No. IB 0052 - 1		
SLB	SA 205 - 15	
ASAHI	KH 205 - 15 AE	
BROWNING	VE - 115	
FAFNIR	GRA 015 RRB	
KOYO	GARA 015 2 RSA	
LINK - BELT	WG 215 UL	
NACHI	KH 205 - 15 AE	
NSK	EN 205 - 15 S	
NTN	AEL 205 - 015 W 3	
RHP	1225 - 15/16 ECG	
SEALMASTER	V - 15 E	
SKF	YET 205 - 015	

Group No. IB 0055 - 1		
SLB	UC 305 - 15	
NSK	UC 305 - 15 S	
NTN	UC 305 - 015 D 1	

Group No. IB 0058 - 1		
SLB	SA 205	
ASAHI	KH 205 AE	
FAFNIR	GRAE 25 RRB	
FAG	16205	
FYH	SA 205	
INA	GRAE 25 NPPB	
KOYO	GARA 100 M2RSA	
NACHI	KH 205 AE	
NSK	EN 205	
NTN	AEL 205 W 3	
RHP	1225 - 25 ECG	
SKF	YET 205	
SNR	1225 - 25 ECG	

Figure MU 34		
<i>Standard Duty Spherical Outside Surface Ball Bearings Eccentric Locking Collar Type</i>		

Figure MU 30		
<i>Standard Duty Spherical Outside Surface Ball Bearings Set Screws Type</i>		
0.9843 in	ID	25.00 mm
2.0472 in	OD	52.00 mm
1.0630 in	IW	27.00 mm

Group No. IB 0056 - 1		
SLB	SB 205	
ASAHI	B 5	

Figure MU 34
Standard Duty Spherical Outside Surface Ball Bearings
Eccentric Locking Collar Type

0.9843 in	ID	25.00 mm
2.0472 in	OD	52.00 mm
1.7441 in	IW	44.30 mm

Group No. IB 0059 - 1

SLB	UEL 205
ASAHI	UG 205 + ER
FAFNIR	GE 25 KRRB
FAG	36205 B
FYH	NA 205
INA	GE 25 KRRB
KOYO	GA 1100 M 2 RSB
LINK - BELT	YG 216 NL
NACHI	UG 205 + ER
NSK	EW 205
NTN	UEL 205 D 1 W 3
RHP	1025 - 25 DECG
SKF	YEL 205

Figure MU 35
Standard Duty Spherical Outside Surface Ball Bearings
Adapter Type

0.9843 in	ID	25.00 mm
2.4409 in	OD	62.00 mm
0.9843 in	IW	25.00 mm

Group No. IB 0060 - 1

SLB	UK 206
ASAHI	UK 206
FYH	UK 206
NACHI	UK 206
NSK	UK 206
NTN	UK 206 D 1
RHP	1030 - 25 KG

Figure MU 33
Medium Duty Spherical Outside Surface Ball Bearings
Set Screws Type

0.9843 in	ID	25.00 mm
2.4409 in	OD	62.00 mm
1.5000 in	IW	38.10 mm

Group No. IB 0061 - 1

SLB	UC X05
ASAHI	UC X05
FYH	UC X05
NSK	UC X05
NTN	UC X05 D 1
SEALMASTER	5305

Figure MU 32
Heavy Duty Spherical Outside Surface Ball Bearings
Set Screws Type

0.9843 in	ID	25.00 mm
2.4409 in	OD	62.00 mm
1.4961 in	IW	38.00 mm

Group No. IB 0062 - 1

SLB	UC 305
ASAHI	UC 305
FYH	UC 305
NSK	UC 305
NTN	UC 305 D1

Figure MU 30
Standard Duty Spherical Outside Surface Ball Bearings
Set Screws Type

1.0000 in	ID	25.40 mm
2.0472 in	OD	52.00 mm
1.0630 in	IW	27.00 mm

Group No. IB 0063 - 1

SLB	SB 205 - 16
ASAHI	B 5 - 16
BROWNING	VS - 116
FAFNIR	GYA 100 RRB
FYH	SB 205 - 16
INA	GAY 100 NPPB
KOYO	PB 16
NACHI	B 5 - 16
NSK	UB 205 - 16 S
NTN	AS 205 - 100
RHP	1225 - 1G
SEALMASTER	V - 16

Figure MU 31
Standard Duty Spherical Outside Surface Ball Bearings
Set Screws Type

1.0000 in	ID	25.40 mm
2.0472 in	OD	52.00 mm
1.3386 in	IW	34.00 mm

Group No. IB 0064 - 1

SLB	UC 205 - 16
ASAHI	UC 205 - 16
BROWNING	VS - 216
FAG	56205.100
FYH	UC 205 - 16
INA	GY 1100 KRRB
KOYO	UC 205 - 16
LINK - BELT	UG 216 NL
NACHI	UC 205 - 16
NSK	UC 205 - 16 S
NTN	UC 205 - 100 D 1
RHP	1025 - 1 G
SEALMASTER	2000 - 2 - 1
SKF	YAR 205 - 100

Figure MU 29
Standard Duty Spherical Outside Surface Ball Bearings
Eccentric Locking Collar Type

1.0000 in	ID	25.40 mm
2.0472 in	OD	52.00 mm
1.2008 in	IW	30.50 mm

Group No. IB 0065 - 1

SLB	SA 205 - 16
ASAHI	KH 205 - 16 AE
BROWNING	VE - 116
FAFNIR	GRA 100 RRB
FAG	16205.100
FYH	SA 205 - 16
INA	GRA 100 NPPB
KOYO	GARA 100 2 RSA
LINK - BELT	WG 216 UL
NACHI	KH 205 - 16 AE
NSK	EN 205 - 16 S
NTN	AEL 205 - 100 W 3
RHP	1225 - 1 ECG
SEALMASTER	V - 16 E
SKF	YET 205 - 100

Figure MU 34
Standard Duty Spherical Outside Surface Ball Bearings
Eccentric Locking Collar Type

1.0000 in	ID	25.40 mm
2.0472 in	OD	52.00 mm
1.7441 in	IW	44.30 mm

Group No. IB 0066 - 1

SLB	UEL 205 - 16
ASAHI	UG 205 - 16 + ER
BROWNING	VE - 216
FAFNIR	G 1100 KRRB
FYH	NA 205 - 16
INA	G 1100 KRRB
KOYO	GA 1100 2 RSB
NACHI	UG 205 - 16 + ER
NSK	EW 205 - 16 S
NTN	UEL 205 - 100 D 1 W 3
RHP	1025 - 1 DECG
SKF	YEL 205 - 100

Figure MU 33
Medium Duty Spherical Outside Surface Ball Bearings
Set Screws Type

1.0000 in	ID	25.40 mm
2.4409 in	OD	62.00 mm
1.5000 in	IW	38.10 mm

Group No. IB 0067 - 1

SLB	UC X05 - 16
ASAHI	UC X05 - 16
BROWNING	VS - 316

FYH	UC X05 - 16
NSK	UC X05 - 16 S
NTN	UC X05 - 100 D 1
SEALMASTER	2000 - 3 - 1

Figure MU 32
Heavy Duty Spherical Outside Surface Ball Bearings
Set Screws Type

1.0000 in	ID	25.40 mm
2.4409 in	OD	62.00 mm
1.4961 in	IW	38.00 mm

Group No. IB 0068 - 1

SLB	UC 305 - 16
ASAHI	UC 305 - 16
FYH	UC 305 - 16
NSK	UC 305 - 16 S
NTN	UC 305 - 100 D 1

Figure MU 30
Standard Duty Spherical Outside Surface Ball Bearings
Set Screws Type

1.0625 in	ID	26.99 mm
2.4409 in	OD	62.00 mm
1.1417 in	IW	29.00 mm

Group No. IB 0069 - 1

SLB	SB 206 - 17
NSK	UB 206 - 17 S
NTN	AS 206 - 101

Figure MU 31
Standard Duty Spherical Outside Surface Ball Bearings
Set Screws Type

1.0625 in	ID	26.99 mm
2.4409 in	OD	62.00 mm
1.5000 in	IW	38.10 mm

Group No. IB 0070 - 1

SLB	UC 206 - 17
ASAHI	UC 206 - 17
NACHI	UC 206 - 17
NSK	UC 206 - 17 S
NTN	UC 206 - 101 D 1
SEALMASTER	2000 - 2 - 11
SKF	YAR 206 - 101

Figure MU 29
Standard Duty Spherical Outside Surface Ball Bearings
Eccentric Locking Collar Type

1.0625 in	ID	26.99 mm
2.4409 in	OD	62.00 mm
1.3346 in	IW	33.90 mm

Group No. IB 0071 - 1

SLB	SA 206 - 17
FAG	16206.101
INA	GRA 101 NPPB
NSK	EN 206 - 17 S
SKF	YET 206 - 101

Figure MU 34
Standard Duty Spherical Outside Surface Ball Bearings
Eccentric Locking Collar Type

1.0625 in	ID	26.99 mm
2.4409 in	OD	62.00 mm
1.9016 in	IW	48.30 mm

Group No. IB 0072 - 1

SLB	UEL 206 - 17
FAFNIR	G 1101 KRRB
NSK	EW 206 - 17 S
NTN	UEL 206 - 101 D 1 W 3
SKF	YEL 206 - 101

Figure MU 33
Medium Duty Spherical Outside Surface Ball Bearings
Set Screws Type

1.0625 in	ID	26.99 mm
2.8346 in	OD	72.00 mm
1.6890 in	IW	42.90 mm

Group No. IB 0073 - 1

SLB	UC X06 - 17
NSK	UC X06 - 17 S
NTN	UC X06 - 101 D 1

Figure MU 32
Heavy Duty Spherical Outside Surface Ball Bearings
Set Screws Type

1.0625 in	ID	26.99 mm
2.8346 in	OD	72.00 mm
1.6929 in	IW	43.00 mm

Group No. IB 0074 - 1

SLB	UC 306 - 17
NSK	UC 306 - 17 S
NTN	UC 306 - 101 D 1

Figure MU 30
Standard Duty Spherical Outside Surface Ball Bearings
Set Screws Type

1.1250 in	ID	28.58 mm
2.4409 in	OD	62.00 mm
1.1417 in	IW	29.00 mm

Group No. IB 0075 - 1

SLB	SB 206 - 18
ASAHI	B 6 - 18
BROWNING	VS - 118
FYH	SB 206 - 18
KOYO	PB 18
NACHI	B 6 - 18
NSK	UB 206 - 18 S
NTN	AS 206 - 102
SEALMASTER	V - 18

Figure MU 31
Standard Duty Spherical Outside Surface Ball Bearings
Set Screws Type

1.1250 in	ID	28.58 mm
2.4409 in	OD	62.00 mm
1.5000 in	IW	38.10 mm

Group No. IB 0076 - 1

SLB	UC 206 - 18
ASAHI	UC 206 - 18
BROWNING	VS - 218
FAG	56206.102
FYH	UC 206 - 18
INA	GY 1102 KRRB
KOYO	UC 206 - 18
LINK - BELT	UG 218 NL
NACHI	UC 206 - 18
NSK	UC 206 - 18S
NTN	UC 206 - 102 D 1
RHP	1030 - 1 1/8 G
SEALMASTER	2000 - 2 - 12
SKF	YAR 206 - 102

Figure MU 29
Standard Duty Spherical Outside Surface Ball Bearings
Eccentric Locking Collar Type

1.1250 in	ID	28.58 mm
2.4409 in	OD	62.00 mm
1.3346 in	IW	33.90 mm

Group No. IB 0077 - 1

SLB	SA 206 - 18
FAG	16206.102
FYH	SA 206 - 18
INA	GRA 102 NPPB
KOYO	GARA 102 2 RSA
NSK	EN 206 - 18 S
RHP	1230 - 1 1/8 ECG
SKF	YET 206 - 102

Figure MU 34
Standard Duty Spherical Outside Surface Ball Bearings
Eccentric Locking Collar Type

1.1250 in	ID	28.58 mm
2.4409 in	OD	62.00 mm
1.9016 in	IW	48.30 mm

Group No. IB 0078 - 1

SLB	UEL 206 - 18	
ASAHI	UG 206 - 18 + ER	
BROWNING	VE - 218	
FAFNIR	G 1102 KRRB	
FYH	NA 206 - 18	
INA	G 1102 KRRB	
KOYO	GA 1102 2 RSB	
LINK - BELT	YG 218 NL	
NACHI	UG 206 - 18 + ER	
NSK	EW 206 - 18 S	
NTN	UEL 206 - 102 D 1 W 3	
RHP	1030 - 1 1/8 DECG	
SKF	YEL 206 - 102	

Figure MU 33

*Medium Duty Spherical Outside Surface Ball Bearings
Set Screws Type*

1.1250 in	ID	28.58 mm
2.8346 in	OD	72.00 mm
1.6890 in	IW	42.90 mm

Group No. IB 0079 - 1

SLB	UC X06 - 18	
ASAHI	UC X06 - 18	
NSK	UC X06 - 18 S	
NTN	UC X06 - 102 D 1	

Figure MU 32

*Heavy Duty Spherical Outside Surface Ball Bearings
Set Screws Type*

1.1250 in	ID	28.58 mm
2.8346 in	OD	72.00 mm
1.6929 in	IW	43.00 mm

Group No. IB 0080 - 1

SLB	UC 306 - 18	
ASAHI	UC 306 - 18	
FYH	UC 306 - 18	
NSK	UC 306 - 18 S	
NTN	UC 306 - 102 D 1	

Figure MU 30

*Standard Duty Spherical Outside Surface Ball Bearings
Set Screws Type*

1.1811 in	ID	30.00 mm
2.4409 in	OD	62.00 mm
1.1417 in	IW	29.00 mm

Group No. IB 0081 - 1

SLB	SB 206	
ASAHI	B 6	
FYH	SB 206	
INA	GAY 30 NPPB	
KOYO	PB 19 M	
NACHI	B 6	
NSK	UB 206	
NTN	AS 206	
RHP	1230 - 30 G	
SNR	1230 - 30 G	

Figure MU 31

*Standard Duty Spherical Outside Surface Ball Bearings
Set Screws Type*

1.1811 in	ID	30.00 mm
2.4409 in	OD	62.00 mm
1.5000 in	IW	38.10 mm

Group No. IB 0082 - 1

SLB	UC 206	
ASAHI	UC 206	
FAG	56206	
FYH	UC 206	
INA	GYE 30 KRRB	
KOYO	UC 206	
LINK - BELT	UG 2 M 30 NL	
NACHI	UC 206	
NSK	UC 206	
NTN	UC 206 D 1	
RHP	1030 - 30 G	
SEALMASTER	5206	
SKF	YAR 206	
SNR	1030 - 30 G	

Figure MU 29

*Standard Duty Spherical Outside Surface Ball Bearings
Eccentric Locking Collar Type*

1.1811 in	ID	30.00 mm
2.4409 in	OD	62.00 mm
1.3346 in	IW	33.90 mm

Group No. IB 0083 - 1

SLB	SA 206	
FAG	16206	
FYH	SA 206	
INA	GRAE 30 NPPB	
KOYO	GARA 103 M2RSA	
NSK	EN 206	
RHP	1230 - 30 ECG	
SKF	YET 206	
SNR	1230 - 30 ECG	

Figure MU 34

*Standard Duty Spherical Outside Surface Ball Bearings
Eccentric Locking Collar Type*

1.1811 in	ID	30.00 mm
2.4409 in	OD	62.00 mm
1.9016 in	IW	48.30 mm

Group No. IB 0084 - 1

SLB	UEL 206	
ASAHI	UG 206 + ER	
FAFNIR	GE 30 KRRB	
FAG	36206B	
FYH	NA 206	
INA	GE 30 KRRB	
KOYO	GA 1103 M 2 RSB	
NACHI	UG 206 + ER	
NSK	EW 206	
NTN	UEL 206 D 1 W 3	
RHP	1030 - 30 DECG	
SKF	YEL 206	

Figure MU 35

*Standard Duty Spherical Outside Surface Ball Bearings
Adapter Type*

1.1811 in	ID	30.00 mm
2.8346 in	OD	72.00 mm
1.0630 in	IW	27.00 mm

Group No. IB 0085 - 1

SLB	UK 207	
ASAHI	UK 207	
FYH	UK 207	
NACHI	UK 207	
NSK	UK 207	
NTN	UK 207 D 1	
RHP	1035 - 30 KG	

Figure MU 33

*Medium Duty Spherical Outside Surface Ball Bearings
Set Screws Type*

1.1811 in	ID	30.00 mm
2.8346 in	OD	72.00 mm
1.6890 in	IW	42.90 mm

Group No. IB 0086 - 1

SLB	UC X06	
ASAHI	UC X06	
FYH	UC X06	
NSK	UC X06	
NTN	UC X06 D 1	
SEALMASTER	5306	

Figure MU 32

*Heavy Duty Spherical Outside Surface Ball Bearings
Set Screws Type*

1.1811 in	ID	30.00 mm
2.8346 in	OD	72.00 mm
1.6929 in	IW	43.00 mm

Group No. IB 0087 - 1		
SLB		UC 306
ASAHI		UC 306
FYH		UC 306
INA		GNYE 30 KRRB
NSK		UC 306
NTN		UC 306 D 1

Figure MU 30 		
<i>Standard Duty Spherical Outside Surface Ball Bearings Set Screws Type</i>		
1.1875 in	ID	30.16 mm
2.4409 in	OD	62.00 mm
1.1417 in	IW	29.00 mm

Group No. IB 0088 - 1		
SLB		SB 206 - 19
ASAHI		B 6 - 19
BROWNING		VS - 119
FYH		SB 206 - 19
INA		GAY 103 NPPB
KOYO		PB 19
NACHI		B 6 - 19
NSK		UB 206 - 19 S
NTN		AS 206 - 103
SEALMASTER		V - 19

Figure MU 31 		
<i>Standard Duty Spherical Outside Surface Ball Bearings Set Screws Type</i>		
1.1875 in	ID	30.16 mm
2.4409 in	OD	62.00 mm
1.5000 in	IW	38.10 mm

Group No. IB 0089 - 1		
SLB		UC 206 - 19
ASAHI		UC 206 - 19
BROWNING		VS - 219
FAG		56206.103
FYH		UC 206 - 19
KOYO		UC 206 - 19
LINK - BELT		UG 219 NL
NACHI		UC 206 - 19
NSK		UC 206 - 19 S
NTN		UC 206 - 103 D 1
RHP		1030 - 1 3/16 G
SEALMASTER		2000 - 2 - 13
SKF		YAR 206 - 103

Figure MU 29 		
<i>Standard Duty Spherical Outside Surface Ball Bearings Eccentric Locking Collar Type</i>		
1.1875 in	ID	30.16 mm
2.4409 in	OD	62.00 mm
1.3346 in	IW	33.90 mm

Group No. IB 0090 - 1		
SLB		SA 206 - 19
FAG		16206.103
FYH		SA 206 - 19
INA		GRA 103 NPPB
KOYO		GARA 103 2 RSA
NSK		EN 206 - 19 S
RHP		1230 - 1 3/16 ECG
SKF		YET 206 - 103

Figure MU 34 		
<i>Standard Duty Spherical Outside Surface Ball Bearings Eccentric Locking Collar Type</i>		
1.1875 in	ID	30.16 mm
2.4409 in	OD	62.00 mm
1.9016 in	IW	48.30 mm

Group No. IB 0091 - 1		
SLB		UEL 206 - 19
ASAHI		UG 206 - 19 + ER
BROWNING		VE - 219
FAFNIR		G 1103 KRRB
FYH		NA 206 - 19
INA		G 1103 KRRB
KOYO		GA 1103 2 RSB
LINK - BELT		YG 219 NL
NACHI		UG 206 - 19 + ER
NSK		EW 206 - 19 S
NTN		UEL 206 - 103 D 1 W 3
RHP		1030 - 1 3/16 DECG
SKF		YEL 206 - 103

Figure MU 33 		
<i>Medium Duty Spherical Outside Surface Ball Bearings Set Screws Type</i>		
1.1875 in	ID	30.16 mm
2.8346 in	OD	72.00 mm
1.6890 in	IW	42.90 mm

Group No. IB 0092 - 1		
SLB		UC X06 - 19
ASAHI		UC X06 - 19
BROWNING		VS - 319
FYH		UC X06 - 19
NSK		UC X06 - 19 S
NTN		UC X06 - 103 D 1
SEALMASTER		2000 - 3 - 13

Figure MU 32 		
<i>Heavy Duty Spherical Outside Surface Ball Bearings Set Screws Type</i>		
1.1875 in	ID	30.16 mm
2.8346 in	OD	72.00 mm
1.6929 in	IW	43.00 mm

Group No. IB 0093 - 1		
SLB		UC 306 - 19
NSK		UC 306 - 19 S
NTN		UC 306 - 103 D 1

Figure MU 30 		
<i>Standard Duty Spherical Outside Surface Ball Bearings Set Screws Type</i>		
1.2500 in	ID	31.75 mm
2.4409 in	OD	62.00 mm
1.1417 in	IW	29.00 mm

Group No. IB 0094 - 1		
SLB		SB 206 - 20
BROWNING		VS - 120 S
KOYO		PB 20
NSK		UB 206 - 20 S
NTN		AS 206 - 104
RHP		1230 - 1 1/4 G
SEALMASTER		V - 20 R

Figure MU 30 		
<i>Standard Duty Spherical Outside Surface Ball Bearings Set Screws Type</i>		
1.2500 in	ID	31.75 mm
2.8346 in	OD	72.00 mm
1.2598 in	IW	32.00 mm

Group No. IB 0095 - 1		
SLB		UC 206 - 20
BROWNING		VS - 220 S
INA		GY 1104 KRRB - 206
LINK - BELT		UG 2 E 20 NL
NSK		UC 206 - 20 S
NTN		UC 206 - 104 D 1
RHP		1030 - 1 1/4 G
SEALMASTER		2000 - 1 - 14
SKF		YAR 206 - 104

Figure MU 31 		
<i>Standard Duty Spherical Outside Surface Ball Bearings Set Screws Type</i>		
1.2500 in	ID	31.75 mm
2.4409 in	OD	62.00 mm
1.5000 in	IW	38.10 mm

Group No. IB 0096 - 1		
SLB		SA 206 - 20
FAFNIR		GRA 103 RRB 2
FAG		16206.104
FYH		SA 206 - 20
INA		GRA 104 NPPB - 206
KOYO		GARA 103 - 1 2 RSA
NSK		EN 206 - 20 S
RHP		1230 - 1 1/4 ECG
SKF		YET 206 - 104

Figure MU 31
Standard Duty Spherical Outside Surface Ball Bearings
Set Screws Type

1.2500 in	ID	31.75 mm
2.8346 in	OD	72.00 mm
1.6890 in	IW	42.90 mm

Group No. IB 0097 - 1

SLB	UEL 206 - 20
ASAHI	UG 206 - 20 + ER
BROWNING	VE - 220 S
FAFNIR	G 1103 KRRB 3
FYH	NA 206 - 20
INA	G 1104 KRRB - 206
KOYO	GA 1103 - 1 2 RSB
LINK - BELT	YG 2 E 20 NL
NACHI	UG 206 - 20 + ER
NSK	EW 206 - 20 S
NTN	UEL 206 - 104 D 1 W 3
RHP	1030 - 1 1/4 DECG
SKF	YEL 206 - 104

Figure MU 29
Standard Duty Spherical Outside Surface Ball Bearings
Eccentric Locking Collar Type

1.2500 in	ID	31.75 mm
2.4409 in	OD	62.00 mm
1.3346 in	IW	33.90 mm

Group No. IB 0098 - 1

SLB	UC X06 - 20
ASAHI	UC X06 - 20
BROWNING	VS - 320
FYH	UC X06 - 20
INA	GY 1104 KRRB
NSK	UC X06 - 20 S
SKF	YAR 207 - 104

Figure MU 29
Standard Duty Spherical Outside Surface Ball Bearings
Eccentric Locking Collar Type

1.2500 in	ID	31.75 mm
2.8346 in	OD	72.00 mm
1.4764 in	IW	37.50 mm

Group No. IB 0099 - 1

SLB	UC 306 - 20
NSK	UC 306 - 20 S

Figure MU 34
Standard Duty Spherical Outside Surface Ball Bearings
Eccentric Locking Collar Type

1.2500 in	ID	31.75 mm
2.4409 in	OD	62.00 mm
1.9016 in	IW	48.30 mm

Group No. IB 0100 - 1

SLB	SB 207 - 20
ASAHI	B 7 - 20
FYH	SB 207 - 20
INA	GAY 104 NPPB
NACHI	B 7 - 20
NSK	UB 207 - 20 S
RHP	1235 - 1 1/4 G
SEALMASTER	V - 20

Figure MU 34
Standard Duty Spherical Outside Surface Ball Bearings
Eccentric Locking Collar Type

1.2500 in	ID	31.75 mm
2.8346 in	OD	72.00 mm
2.0118 in	IW	51.10 mm

Group No. IB 0101 - 1

SLB	UC 207 - 20
ASAHI	UC 207 - 20
BROWNING	VS - 320
FAG	56207.104
FYH	UC 207 - 20
INA	GY 1104 KRRB
KOYO	UC 207 - 20
NACHI	UC 207 - 20
NSK	UC 207 - 20 S
NTN	UC 207 - 104 D 1
RHP	1035 - 1 1/4 G
SEALMASTER	2000 - 2 - 14
SKF	YAR 207 - 104

Figure MU 33
Medium Duty Spherical Outside Surface Ball Bearings
Set Screws Type

1.2500 in	ID	31.75 mm
2.8346 in	OD	72.00 mm
1.6890 in	IW	42.90 mm

Group No. IB 0102 - 1

SLB	SA 207 - 20
ASAHI	KH 207 - 20 AE
FAFNIR	GRA104 RRB
FYH	SA 207 - 20
INA	GRA 104 NPPB
KOYO	GARA 104 2 RSA
LINK - BELT	WG 220 EL
NACHI	KH 207 - 20 AE
NSK	EN 207 - 20 S
NTN	AEL 207 - 104 W 3
RHP	1235 - 1 1/4 ECG
SKF	YET 207 - 104

Figure MU 33
Medium Duty Spherical Outside Surface Ball Bearings
Set Screws Type

1.2500 in	ID	31.75 mm
3.1496 in	OD	80.00 mm
1.9370 in	IW	49.20 mm

Group No. IB 0103 - 1

SLB	UEL 207 - 20
ASAHI	UG 207 - 20 + ER
BROWNING	VE - 220
FAFNIR	G 1104 KRRB
FYH	NA 207 - 20
INA	G 1104 KRRB
KOYO	GA 1104 2 RSB
LINK - BELT	YG 220 NL
NACHI	UG 207 - 20 + ER
NSK	EW 207 - 20 S
NTN	UEL 207 - 104 D 1 W 3
RHP	1035 - 1 1/4 DECG
SKF	YEL 207 - 104

Figure MU 32
Heavy Duty Spherical Outside Surface Ball Bearings
Set Screws Type

1.2500 in	ID	31.75 mm
2.8346 in	OD	72.00 mm
1.6929 in	IW	43.00 mm

Group No. IB 0104 - 1

SLB	UC X07 - 20
NSK	UC X07 - 20 S

Figure MU 32
Heavy Duty Spherical Outside Surface Ball Bearings
Set Screws Type

1.2500 in	ID	31.75 mm
3.1496 in	OD	80.00 mm
1.8898 in	IW	48.00 mm

Group No. IB 0105 - 1

SLB	UC 307 - 20
ASAHI	UC 307 - 20
FYH	UC 307 - 20
NSK	UC 307 - 20 S
NTN	UC 307 - 104 D 1

Figure MU 30
Standard Duty Spherical Outside Surface Ball Bearings
Set Screws Type

1.3125 in	ID	33.34 mm
2.8346 in	OD	72.00 mm
1.2598 in	IW	32.00 mm

Group No. IB 0106 - 1		
SLB	SB 207 - 21	
ASAHI	B 7 - 21	
KOYO	PB 21	
NACHI	B 7 - 21	
NSK	UB 207 - 21 S	

Figure MU 31 		
<i>Standard Duty Spherical Outside Surface Ball Bearings Set Screws Type</i>		
1.3125 in	ID	33.34 mm
2.8346 in	OD	72.00 mm
1.6890 in	IW	42.90 mm

Group No. IB 0107 - 1		
SLB	UC 207 - 21	
ASAHI	UC 207 - 21	
FYH	UC 207 - 21	
KOYO	UC 207 - 21	
NACHI	UC 207 - 21	
NSK	UC 207 - 21 S	
NTN	UC 207 - 105 D 1	
RHP	1035 - 1 5/16 G	
SEALMASTER	2000 - 2 - 15	
SKF	YAR 207 - 105	

Figure MU 29 		
<i>Standard Duty Spherical Outside Surface Ball Bearings Eccentric Locking Collar Type</i>		
1.3125 in	ID	33.34 mm
2.8346 in	OD	72.00 mm
1.4764 in	IW	37.50 mm

Group No. IB 0108 - 1		
SLB	SA 207 - 21	
ASAHI	KH 207 - 21 AE	
FAFNIR	GRA 105 RRB	
KOYO	GARA 105 2 RSA	
NACHI	KH 207 - 21 AE	
NSK	EN 207 - 21 S	
NTN	AEL 207 - 105 W 3	
SKF	YET 207 - 105	

Figure MU 34 		
<i>Standard Duty Spherical Outside Surface Ball Bearings Eccentric Locking Collar Type</i>		
1.3125 in	ID	33.34 mm
2.8346 in	OD	72.00 mm
2.0118 in	IW	51.10 mm

Group No. IB 0109 - 1		
SLB	UEL 207 - 21	
ASAHI	UG 207 - 21 + ER	
FAFNIR	G 1105 KRRB	

KOYO	GA 1105 2 RSB	
NACHI	UG 207 - 21 + ER	
NSK	EW 207 - 21 S	
NTN	UEL 207 - 105 D 1 W 3	
SKF	YEL 207 - 105	

Figure MU 33 		
<i>Medium Duty Spherical Outside Surface Ball Bearings Set Screws Type</i>		
1.3125 in	ID	33.34 mm
3.1496 in	OD	80.00 mm
1.9370 in	IW	49.20 mm

Group No. IB 0110 - 1		
SLB	UC X07 - 21	
NSK	UC X07 - 21 S	
NTN	UC X07 - 105 D 1	

Figure MU 32 		
<i>Heavy Duty Spherical Outside Surface Ball Bearings Set Screws Type</i>		
1.3125 in	ID	33.34 mm
3.1496 in	OD	80.00 mm
1.8898 in	IW	48.00 mm

Group No. IB 0111 - 1		
SLB	UC 307 - 21	
NSK	UC 307 - 21 S	
NTN	UC 307 - 105 D 1	

Figure MU 30 		
<i>Standard Duty Spherical Outside Surface Ball Bearings Set Screws Type</i>		
1.3750 in	ID	34.93 mm
2.8346 in	OD	72.00 mm
1.2598 in	IW	32.00 mm

Group No. IB 0112 - 1		
SLB	SB 207 - 22	
ASAHI	B 7 - 22	
BROWNING	VS - 122	
FYH	SB 207 - 22	
KOYO	PB 22	
NACHI	B 7 - 22	
NSK	UB 207 - 22 S	
SEALMASTER	V - 22	

Figure MU 31 		
<i>Standard Duty Spherical Outside Surface Ball Bearings Set Screws Type</i>		
1.3750 in	ID	34.93 mm
2.8346 in	OD	72.00 mm
1.6890 in	IW	42.90 mm

Group No. IB 0113 - 1		
SLB	UC 207 - 22	
ASAHI	UC 207 - 22	
BROWNING	VS - 222	
FAG	56207.106	
FYH	UC 207 - 22	
INA	GY 1106 KRRB	
KOYO	UC 207 - 22	
NACHI	UC 207 - 22	
NSK	UC 207 - 22 S	
NTN	UC 207 - 106 D 1	
RHP	1035 - 1 3/8 G	
SEALMASTER	2000 - 2 - 16	
SKF	YAR 207 - 106	

Figure MU 29 		
<i>Standard Duty Spherical Outside Surface Ball Bearings Eccentric Locking Collar Type</i>		
1.3750 in	ID	34.93 mm
2.8346 in	OD	72.00 mm
1.4764 in	IW	37.50 mm

Group No. IB 0114 - 1		
SLB	SA 207 - 22	
ASAHI	KH 207 - 22 AE	
FAFNIR	GRA 106 RRB	
FAG	16207.106	
FYH	SA 207 - 22	
INA	GRA 106 NPPB	
KOYO	GARA 106 2 RSA	
LINK - BELT	WG 222 EL	
NACHI	KH 207 - 22 AE	
NSK	EN 207 - 22 S	
NTN	AEL 207 - 106 W 3	
RHP	1235 - 1 3/8 ECG	
SKF	YET 207 - 106	

Figure MU 34 		
<i>Standard Duty Spherical Outside Surface Ball Bearings Eccentric Locking Collar Type</i>		
1.3750 in	ID	34.93 mm
2.8346 in	OD	72.00 mm
2.0118 in	IW	51.10 mm

Group No. IB 0115 - 1		
SLB	UEL 207 - 22	
ASAHI	UG 207 - 22 + ER	
BROWNING	VE - 222	
FAFNIR	G 1106 KRRB	
FYH	NA 207 - 22	
INA	G 1106 KRRB	
KOYO	GA 1106 2 RSB	
LINK - BELT	YG 222 NL	
NACHI	UG 207 - 22 + ER	
NSK	EW 207 - 22 S	
NTN	UEL 207 - 106 D 1 W 3	
RHP	1035 - 1 3/8 DECG	
SKF	YEL 207 - 106	

Figure MU 33

Medium Duty Spherical Outside Surface Ball Bearings
Set Screws Type

1.3750 in	ID	34.93 mm
3.1496 in	OD	80.00 mm
1.9370 in	IW	49.20 mm

Group No. IB 0116 - 1

SLB	UC X07 - 22
ASAHI	UC X07 - 22
FYH	UC X07 - 22
NSK	UC X07 - 22 S
NTN	UC X07 - 106 D 1

Figure MU 32

Heavy Duty Spherical Outside Surface Ball Bearings
Set Screws Type

1.3750 in	ID	34.93 mm
3.1496 in	OD	80.00 mm
1.8898 in	IW	48.00 mm

Group No. IB 0117 - 1

SLB	UC 307 - 22
ASAHI	UC 307 - 22
FYH	UC 307 - 22
NSK	UC 307 - 22 S
NTN	UC 307 - 106 D 1

Figure MU 30

Standard Duty Spherical Outside Surface Ball Bearings
Set Screws Type

1.3780 in	ID	35.00 mm
2.8346 in	OD	72.00 mm
1.2598 in	IW	32.00 mm

Group No. IB 0118 - 1

SLB	SB 207
ASAHI	B 7
FYH	SB 207
INA	GAY 35 NPPB
KOYO	PB 22 M
NACHI	B 7
NSK	UB 207
RHP	1235 - 35 G
SNR	1235 - 35 G

Figure MU 31

Standard Duty Spherical Outside Surface Ball Bearings
Set Screws Type

1.3780 in	ID	35.00 mm
2.8346 in	OD	72.00 mm
1.6890 in	IW	42.90 mm

Group No. IB 0119 - 1

SLB	UC 207
ASAHI	UC 207
FAG	56207
FYH	UC 207
INA	GYE 35 KRRB
KOYO	UC 207
NACHI	UC 207
NSK	UC 207
NTN	UC 207 D 1
RHP	1035 - 35 G
SEALMASTER	5207
SKF	YAR 207
SNR	1035 - 35 G

Figure MU 29

Standard Duty Spherical Outside Surface Ball Bearings
Eccentric Locking Collar Type

1.3780 in	ID	35.00 mm
2.8346 in	OD	72.00 mm
1.4764 in	IW	37.50 mm

Group No. IB 0120 - 1

SLB	SA 207
ASAHI	KH 207 AE
FAFNIR	GRAE 35 RRB
FAG	16207
FYH	SA 207
INA	GRAE 35 NPPB
KOYO	GARA 106 M 2 RSA
NACHI	KH 207 AE
NSK	EN 207
NTN	AEL 207 W 3
RHP	1235 - 35 ECG
SKF	YET 207
SNR	1235 - 35 ECG

Figure MU 34

Standard Duty Spherical Outside Surface Ball Bearings
Eccentric Locking Collar Type

1.3780 in	ID	35.00 mm
2.8346 in	OD	72.00 mm
2.0118 in	IW	51.10 mm

Group No. IB 0121 - 1

SLB	UEL 207
ASAHI	UG 207 + ER
FAFNIR	GE 35 KRRB
FAG	36207 B
FYH	NA 207
INA	GE 35 KRRB
KOYO	GA 1106 M 2 RSB
NACHI	UG 207 + ER
NSK	EW 207
NTN	UEL 207 D 1 W 3
RHP	1035 - 35 DECG
SKF	YEL 207

Figure MU 35

Standard Duty Spherical Outside Surface Ball Bearings
Adapter Type

1.3780 in	ID	35.00 mm
3.1496 in	OD	80.00 mm
1.1417 in	IW	29.00 mm

Group No. IB 0122 - 1

SLB	UK 208
ASAHI	UK 208
FYH	UK 208
NACHI	UK 208
NSK	UK 208
NTN	UK 208 D 1
RHP	1040 - 35 KG

Figure MU 33

Medium Duty Spherical Outside Surface Ball Bearings
Set Screws Type

1.3780 in	ID	35.00 mm
3.1496 in	OD	80.00 mm
1.9370 in	IW	49.20 mm

Group No. IB 0123 - 1

SLB	UC X07
ASAHI	UC X07
FYH	UC X07
NSK	UC X07
NTN	UC X07 D 1
SEALMASTER	5307

Figure MU 32

Heavy Duty Spherical Outside Surface Ball Bearings
Set Screws Type

1.3780 in	ID	35.00 mm
3.1496 in	OD	80.00 mm
1.8898 in	IW	48.00 mm

Group No. IB 0124 - 1

SLB	UC 307
ASAHI	UC 307
FYH	UC 307
NSK	UC 307
NTN	UC 307 D 1

Figure MU 30

Standard Duty Spherical Outside Surface Ball Bearings
Set Screws Type

1.4375 in	ID	36.51 mm
2.8346 in	OD	72.00 mm
1.2598 in	IW	32.00 mm

Group No. IB 0125 - 1	
SLB	SB 207 - 23
ASAHI	B 7 - 23
BROWNING	VS - 123
FYH	SB 207 - 23
INA	GAY 107 NPPB
KOYO	PB 23
NACHI	B 7 - 23
NSK	UB 207 - 23 S
SEALMASTER	V - 23

Figure MU 31	
<i>Standard Duty Spherical Outside Surface Ball Bearings Set Screws Type</i>	
1.4375 in	ID 36.51 mm
2.8346 in	OD 72.00 mm
1.6890 in	IW 42.90 mm

Group No. IB 0126 - 1	
SLB	UC 207 - 23
ASAHI	UC 207 - 23
BROWNING	VS - 223
FAG	56207.107
FYH	UC 207 - 23
KOYO	UC 207 - 23
NACHI	UC 207 - 23
NSK	UC 207 - 23 S
NTN	UC 207 - 107 D 1
RHP	1035 - 1 7/16 G
SEALMASTER	2000 - 2 - 17
SKF	YAR 207 - 107

Figure MU 29	
<i>Standard Duty Spherical Outside Surface Ball Bearings Eccentric Locking Collar Type</i>	
1.4375 in	ID 36.51 mm
2.8346 in	OD 72.00 mm
1.4764 in	IW 37.50 mm

Group No. IB 0127 - 1	
SLB	SA 207 - 23
ASAHI	KH 207 - 23 AE
FAFNIR	GRA 107 RRB
FYH	SA 207 - 23
INA	GRA 107 NPPB
KOYO	GARA 107 2 RSA
LINK - BELT	WG 223 EL
NACHI	KH 207 - 23 AE
NSK	EN 207 - 23 S
NTN	AEL 207 - 107 W 3
RHP	1235 - 1 7/16 ECG
SKF	YET 207 - 107

Figure MU 34	
<i>Standard Duty Spherical Outside Surface Ball Bearings Eccentric Locking Collar Type</i>	
1.5000 in	ID 38.10 mm
3.1496 in	OD 80.00 mm
1.3386 in	IW 34.00 mm

1.4375 in	ID 36.51 mm
2.8346 in	OD 72.00 mm
2.0118 in	IW 51.10 mm

Group No. IB 0128 - 1	
SLB	UEL 207 - 23
ASAHI	UG 207 - 23 + ER
BROWNING	VE - 223
FAFNIR	G 1107 KRRB
FYH	NA 207 - 23
INA	G 1107 KRRB
KOYO	GA 1107 2 RSB
LINK - BELT	YG 223 NL
NACHI	UG 207 - 23 + ER
NSK	EW 207 - 23 S
NTN	UEL 207 - 107 D 1 W 3
RHP	1035 - 1 7/16 DECG
SKF	YEL 207 - 107

Figure MU 33	
<i>Medium Duty Spherical Outside Surface Ball Bearings Set Screws Type</i>	
1.4375 in	ID 36.51 mm
3.1496 in	OD 80.00 mm
1.9370 in	IW 49.20 mm

Group No. IB 0129 - 1	
SLB	UC X07 - 23
ASAHI	UC X07 - 23
BROWNING	VS - 323
FYH	UC X07 - 23
NSK	UC X07 - 23 S
NTN	UC X07 - 107 D 1
SEALMASTER	2000 - 3 - 17
SKF	YAR 208 - 107

Figure MU 32	
<i>Heavy Duty Spherical Outside Surface Ball Bearings Set Screws Type</i>	
1.4375 in	ID 36.51 mm
3.1496 in	OD 80.00 mm
1.8898 in	IW 48.00 mm

Group No. IB 0130 - 1	
SLB	UC 307 - 23
NSK	UC 307 - 23 S
NTN	UC 307 - 107 D 1

Figure MU 30	
<i>Standard Duty Spherical Outside Surface Ball Bearings Set Screws Type</i>	
1.5000 in	ID 38.10 mm
3.1496 in	OD 80.00 mm
1.3386 in	IW 34.00 mm

Group No. IB 0131 - 1	
SLB	SB 208 - 24
FYH	SB 208 - 24
INA	GAY 108 NPPB
NSK	UB 208 - 24 S

Figure MU 31	
<i>Standard Duty Spherical Outside Surface Ball Bearings Set Screws Type</i>	
1.5000 in	ID 38.10 mm
3.1496 in	OD 80.00 mm
1.9370 in	IW 49.20 mm

Group No. IB 0132 - 1	
SLB	UC 208 - 24
ASAHI	UC 208 - 24
BROWNING	VS - 224
FAG	56208.108
FYH	UC 208 - 24
INA	GY 1108 KRRB
KOYO	UC 208 - 24
LINK - BELT	UG 224 NL
NACHI	UC 208 - 24
NSK	UC 208 - 24 S
NTN	UC 208 - 108 D 1
RHP	1040 - 1 1/2 G
SEALMASTER	2000 - 2 - 18
SKF	YAR 208 - 108

Figure MU 29	
<i>Standard Duty Spherical Outside Surface Ball Bearings Eccentric Locking Collar Type</i>	
1.5000 in	ID 38.10 mm
3.1496 in	OD 80.00 mm
1.5945 in	IW 40.50 mm

Group No. IB 0133 - 1	
SLB	SA 208 - 24
FAG	16208.108
FYH	SA 208 - 24
INA	GRA 108 NPPB
KOYO	GARA 108 2 RSA
NSK	EN 208 - 24 S
SKF	YET 208 - 108

Figure MU 34	
<i>Standard Duty Spherical Outside Surface Ball Bearings Eccentric Locking Collar Type</i>	
1.5000 in	ID 38.10 mm
3.1496 in	OD 80.00 mm
2.2165 in	IW 56.30 mm

Group No. IB 0134 - 1	
SLB	UEL 208 - 24
ASAHI	UG 208 - 24 + ER

BROWNING	VE - 224
FAFNIR	G 1108 KRRB
FYH	NA 208 - 24
INA	G 1108 KRRB
KOYO	GA 1108 2 RSB
LINK - BELT	YG 224 NL
NACHI	UG 208 - 24 + ER
NSK	EW 208 - 24 S
NTN	UEL 208 - 108 D 1 W 3
RHP	1040 - 1 1/2 DECG
SKF	YEL 208 - 108

Figure MU 33 
Medium Duty Spherical Outside Surface Ball Bearings
 Set Screws Type

1.5000 in	ID	38.10 mm
3.3465 in	OD	85.00 mm
1.9370 in	IW	49.20 mm

Group No. IB 0135 - 1

SLB	UC X08 - 24
ASAHI	UC X08 - 24
BROWNING	VS - 324
FYH	UC X08 - 24
INA	GY 1108 KRRB - 209
NSK	UC X08 - 24 S
NTN	UC X08 - 108 D 1
SEALMASTER	2000 - 3 - 18
SKF	YAR 209 - 108

Figure MU 32 
Heavy Duty Spherical Outside Surface Ball Bearings
 Set Screws Type

1.5000 in	ID	38.10 mm
3.5433 in	OD	90.00 mm
2.0472 in	IW	52.00 mm

Group No. IB 0136 - 1

SLB	UC 308 - 24
ASAHI	UC 308 - 24
FYH	UC 308 - 24
NSK	UC 308 - 24 S
NTN	UC 308 - 108 D 1

Figure MU 30 
Standard Duty Spherical Outside Surface Ball Bearings
 Set Screws Type

1.5625 in	ID	39.69 mm
3.1496 in	OD	80.00 mm
1.3386 in	IW	34.00 mm

Group No. IB 0137 - 1

SLB	SB 208 - 25
FYH	SB 208 - 25

Figure MU 31 
Standard Duty Spherical Outside Surface Ball Bearings
 Set Screws Type

1.5625 in	ID	39.69 mm
3.1496 in	OD	80.00 mm
1.9370 in	IW	49.20 mm

Group No. IB 0138 - 1

SLB	UC 208 - 25
ASAHI	UC 208 - 25
FYH	UC 208 - 25
KOYO	UC 208 - 25
NACHI	UC 208 - 25
NTN	UC 208 - 109 D 1
SEALMASTER	2000 - 2 - 19
SKF	YAR 208 - 109

Figure MU 29 
Standard Duty Spherical Outside Surface Ball Bearings
 Eccentric Locking Collar Type

1.5625 in	ID	39.69 mm
3.1496 in	OD	80.00 mm
1.5945 in	IW	40.50 mm

Group No. IB 0139 - 1

SLB	SA 208 - 25
KOYO	GARA 109 2 RSA
SKF	YET 208 - 109

Figure MU 34 
Standard Duty Spherical Outside Surface Ball Bearings
 Eccentric Locking Collar Type

1.5625 in	ID	39.69 mm
3.1496 in	OD	80.00 mm
2.2165 in	IW	56.30 mm

Group No. IB 0140 - 1

SLB	UEL 208 - 25
ASAHI	UG 208 - 25 + ER
FAFNIR	G 1109 KRRB
KOYO	GA 1109 2 RSB
NACHI	UG 208 - 25 + ER
NTN	UEL 208 - 109 D 1 W 3
SKF	YEL 208 - 109

Figure MU 33 
Medium Duty Spherical Outside Surface Ball Bearings
 Set Screws Type

1.5625 in	ID	39.69 mm
3.3465 in	OD	85.00 mm
1.9370 in	IW	49.20 mm

Group No. IB 0141 - 1

SLB	UC X08 - 25
NTN	UC X08 - 109 D 1

Figure MU 32 
Heavy Duty Spherical Outside Surface Ball Bearings
 Set Screws Type

1.5625 in	ID	39.69 mm
3.5433 in	OD	90.00 mm
2.0472 in	IW	52.00 mm

Group No. IB 0142 - 1

SLB	UC 308 - 25
NTN	UC 308 - 109 D 1

Figure MU 30 
Standard Duty Spherical Outside Surface Ball Bearings
 Set Screws Type

1.5748 in	ID	40.00 mm
3.1496 in	OD	80.00 mm
1.3386 in	IW	34.00 mm

Group No. IB 0143 - 1

SLB	SB 208
FYH	SB 208
INA	GAY 40 NPPB
NSK	UB 208
SNR	1240 - 40 G

Figure MU 31 
Standard Duty Spherical Outside Surface Ball Bearings
 Set Screws Type

1.5748 in	ID	40.00 mm
3.1496 in	OD	80.00 mm
1.9370 in	IW	49.20 mm

Group No. IB 0144 - 1

SLB	UC 208
ASAHI	UC 208
FAG	56208
FYH	UC 208
INA	GYE 40 KRRB
KOYO	UC 208
LINK - BELT	UG 2 M 40 NL
NACHI	UC 208
NSK	UC 208
NTN	UC 208 D 1
RHP	1040 - 40 G
SEALMASTER	5208
SKF	YAR 208
SNR	1040 - 40 G

Figure MU 29 
Standard Duty Spherical Outside Surface Ball Bearings
 Eccentric Locking Collar Type

1.5748 in	ID	40.00 mm
3.1496 in	OD	80.00 mm
1.5945 in	IW	40.50 mm

Group No. IB 0145 - 1		
SLB	SA 208	
FAG	16208	
FYH	SA 208	
INA	GRAE 40 NPPB	
KOYO	GARA 109 M 2 RSA	
NSK	EN 208	
SKF	YET 208	
SNR	1240 - 40 ECG	

Figure MU 34 		
Standard Duty Spherical Outside Surface Ball Bearings Eccentric Locking Collar Type		
1.5748 in	ID	40.00 mm
3.1496 in	OD	80.00 mm
2.2165 in	IW	56.30 mm

Group No. IB 0146 - 1		
SLB	UEL 208	
ASAHI	UG 208 + ER	
FAFNIR	GE 40 KRRB	
FAG	36208 B	
FYH	NA 208	
INA	GE 40 KRRB	
KOYO	GA 1109 M 2 RSB	
NACHI	UG 208 + ER	
NSK	EW 208	
NTN	UEL 208 D 1 W 3	
RHP	1040 - 40 DECG	
SKF	YEL 208	

Figure MU 35 		
Standard Duty Spherical Outside Surface Ball Bearings Adapter Type		
1.5748 in	ID	40.00 mm
3.3465 in	OD	85.00 mm
1.1811 in	IW	30.00 mm

Group No. IB 0147 - 1		
SLB	UK 209	
ASAHI	UK 209	
FYH	UK 209	
NACHI	UK 209	
NSK	UK 209	
NTN	UK 209 D 1	
RHP	1045 - 40 KG	

Figure MU 33 		
Medium Duty Spherical Outside Surface Ball Bearings Set Screws Type		
1.5748 in	ID	40.00 mm
3.3465 in	OD	85.00 mm
1.9370 in	IW	49.20 mm

Group No. IB 0148 - 1		
SLB	UC X08	
ASAHI	UC X08	
FYH	UC X08	
INA	GYE 40 KRRB - 209	
NSK	UC X08	
NTN	UC X08 D 1	
SEALMASTER	5308	

Figure MU 32 		
Heavy Duty Spherical Outside Surface Ball Bearings Set Screws Type		
1.5748 in	ID	40.00 mm
3.5433 in	OD	90.00 mm
2.0472 in	IW	52.00 mm

Group No. IB 0149 - 1		
SLB	UC 308	
ASAHI	UC 308	
FYH	UC 308	
INA	GNYE 40 KRRB	
NSK	UC 308	
NTN	UC 308 D 1	

Figure MU 31 		
Standard Duty Spherical Outside Surface Ball Bearings Set Screws Type		
1.6250 in	ID	41.28 mm
3.3465 in	OD	85.00 mm
1.9370 in	IW	49.20 mm

Group No. IB 0150 - 1		
SLB	UC 209 - 26	
ASAHI	UC 209 - 26	
BROWNING	VS - 226	
FYH	UC 209 - 26	
KOYO	UC 209 - 26	
NACHI	UC 209 - 26	
NSK	UC 209 - 26 S	
NTN	UC 209 - 110 D 1	
RHP	1045 - 1 5/8 G	
SEALMASTER	2 - 110	
SKF	YAR 209 - 110	

Figure MU 29 		
Standard Duty Spherical Outside Surface Ball Bearings Eccentric Locking Collar Type		
1.6250 in	ID	41.28 mm
3.3465 in	OD	85.00 mm
1.6614 in	IW	42.20 mm

Group No. IB 0151 - 1		
SLB	SA 209 - 26	
ASAHI	KH 209 - 26 BE	

FAFNIR	GRA 110 RRB
KOYO	GARA 110 2 RSA
LINK - BELT	WG 226 UL
NACHI	KH 209 - 26 BE
NSK	EN 209 - 26 S
RHP	1245 - 1 5/8 ECG
SKF	YET 209 - 110

Figure MU 34 		
Standard Duty Spherical Outside Surface Ball Bearings Eccentric Locking Collar Type		
1.6250 in	ID	41.28 mm
3.3465 in	OD	85.00 mm
2.2165 in	IW	56.30 mm

Group No. IB 0152 - 1		
SLB	UEL 209 - 26	
ASAHI	UG 209 - 26 + ER	
BROWNING	VE - 226	
FAFNIR	G 1110 KRRB	
FYH	NA 209 - 26	
INA	G 1110 KRRB	
KOYO	GA 1110 2 RSB	
LINK - BELT	YG 226 NL	
NACHI	UG 209 - 26 + ER	
NSK	EW 209 - 26 S	
NTN	UEL 209 - 110 D 1 W 3	
RHP	1045 - 1 5/8 DECG	
SKF	YEL 209 - 110	

Figure MU 33 		
Medium Duty Spherical Outside Surface Ball Bearings Set Screws Type		
1.6250 in	ID	41.28 mm
3.5433 in	OD	90.00 mm
2.0315 in	IW	51.60 mm

Group No. IB 0153 - 1		
SLB	UC X09 - 26	
ASAHI	UC X09 - 26	
NSK	UC X09 - 26 S	
NTN	UC X09 - 110 D 1	

Figure MU 32 		
Heavy Duty Spherical Outside Surface Ball Bearings Set Screws Type		
1.6250 in	ID	41.28 mm
3.9370 in	OD	100.00 mm
2.2441 in	IW	57.00 mm

Group No. IB 0154 - 1		
SLB	UC 309 - 26	
ASAHI	UC 309 - 26	
NSK	UC 309 - 26 S	
NTN	UC 309 - 110 D 1	

Figure MU 31
Standard Duty Spherical Outside Surface Ball Bearings
Set Screws Type

1.6875 in	ID	42.86 mm
3.3465 in	OD	85.00 mm
1.9370 in	IW	49.20 mm

Group No. IB 0155 - 1

SLB	UC 209 - 27
ASAHI	UC 209 - 27
BROWNING	VS - 227
FYH	UC 209 - 27
KOYO	UC 209 - 27
NACHI	UC 209 - 27
NSK	UC 209 - 27 S
NTN	UC 209 - 111 D 1
RHP	1045 - 1 11/16 G
SEALMASTER	2 - 111
SKF	YAR 209 - 111

NSK	EW 209 - 27 S
NTN	UEL 209 - 111 D 1 W 3
RHP	1045 - 1 11/16 DECG
SKF	YEL 209 - 111

Figure MU 33
Medium Duty Spherical Outside Surface Ball Bearings
Set Screws Type

1.6875 in	ID	42.86 mm
3.5433 in	OD	90.00 mm
2.0315 in	IW	51.60 mm

Group No. IB 0158 - 1

SLB	UC X09 - 27
ASAHI	UC X09 - 27
BROWNING	VS - 327
FYH	UC X09 - 27
NSK	UC X09 - 27 S
NTN	UC X09 - 111 D 1
SEALMASTER	3 - 111
SKF	YAR 210 - 111

Figure MU 29
Standard Duty Spherical Outside Surface Ball Bearings
Eccentric Locking Collar Type

1.7500 in	ID	44.45 mm
3.3465 in	OD	85.00 mm
1.6614 in	IW	42.20 mm

Group No. IB 0161 - 1

SLB	SA 209 - 28
ASAHI	KH 209 - 28 BE
FAFNIR	GRA 112 RRB
FAG	16209.112
INA	GRA 112 NPPB
KOYO	GARA 112 2 RSA
LINK - BELT	WG 228 UL
NACHI	KH 209 - 28 BE
NSK	EN 209 - 28 S
RHP	1245 - 1 3/4 ECG
SKF	YET 209 - 112

Figure MU 29
Standard Duty Spherical Outside Surface Ball Bearings
Eccentric Locking Collar Type

1.6875 in	ID	42.86 mm
3.3465 in	OD	85.00 mm
1.6614 in	IW	42.20 mm

Group No. IB 0156 - 1

SLB	SA 209 - 27
ASAHI	KH 209 - 27 BE
FAFNIR	GRA 111 RRB
KOYO	GARA 111 2 RSA
LINK - BELT	WG 227 UL
NACHI	KH 209 - 27 BE
NSK	EN 209 - 27 S
RHP	1245 - 1 11/16 ECG
SKF	YET 209 - 111

Figure MU 32
Heavy Duty Spherical Outside Surface Ball Bearings
Set Screws Type

1.6875 in	ID	42.86 mm
3.9370 in	OD	100.00 mm
2.2441 in	IW	57.00 mm

Group No. IB 0159 - 1

SLB	UC 309 - 27
NSK	UC 309 - 27 S
NTN	UC 309 - 111 D 1

Figure MU 34
Standard Duty Spherical Outside Surface Ball Bearings
Eccentric Locking Collar Type

1.7500 in	ID	44.45 mm
3.3465 in	OD	85.00 mm
2.2165 in	IW	56.30 mm

Group No. IB 0162 - 1

SLB	UEL 209 - 28
ASAHI	UG 209 - 28 + ER
BROWNING	VE - 228
FAFNIR	G 1112 KRRB
FYH	NA 209 - 28
INA	G 1112 KRRB
KOYO	GA 1112 2 RSB
LINK - BELT	YG 228 NL
NACHI	UG 209 - 28 + ER
NSK	EW 209 - 28 S
NTN	UEL 209 - 112 D 1 W 3
RHP	1045 - 1 3/4 DECG
SKF	YEL 209 - 112

Figure MU 34
Standard Duty Spherical Outside Surface Ball Bearings
Eccentric Locking Collar Type

1.6875 in	ID	42.86 mm
3.3465 in	OD	85.00 mm
2.2165 in	IW	56.30 mm

Group No. IB 0157 - 1

SLB	UEL 209 - 27
ASAHI	UG 209 - 27 + ER
BROWNING	VE - 227
FAFNIR	G 1111 KRRB
FYH	NA 209 - 27
INA	G 1111 KRRB
KOYO	GA 1111 2 RSB
LINK - BELT	YG 227 NL
NACHI	UG 209 - 27 + ER

Figure MU 31
Standard Duty Spherical Outside Surface Ball Bearings
Set Screws Type

1.7500 in	ID	44.45 mm
3.3465 in	OD	85.00 mm
1.9370 in	IW	49.20 mm

Group No. IB 0160 - 1

SLB	UC 209 - 28
ASAHI	UC 209 - 28
BROWNING	VS - 228
FAG	56209.112
FYH	UC 209 - 28
INA	GY 1112 KRRB
KOYO	UC 209 - 28
NACHI	UC 209 - 28
NSK	UC 209 - 28 S
NTN	UC209 - 112 D 1
RHP	1045 - 1 3/4 G
SEALMASTER	2 - 112
SKF	YAR 209 - 112

Figure MU 33
Medium Duty Spherical Outside Surface Ball Bearings
Set Screws Type

1.7500 in	ID	44.45 mm
3.5433 in	OD	90.00 mm
2.0315 in	IW	51.60 mm

Group No. IB 0163 - 1

SLB	UC X09 - 28
ASAHI	UC X09 - 28
BROWNING	VS - 328
FYH	UC X09 - 28
INA	GY 1112 KRRB - 210

NSK	UC X09 - 28 S
NTN	UC X09 - 112 D 1
SEALMASTER	3 - 112
SKF	YAR 210 - 112

KOYO	GARA 112 M 2 RSA
NACHI	KH 209 BE
NSK	EN 209
RHP	1245 - 45 ECG
SKF	YET 209
SNR	1245 - 45 ECG

FYH	UC X09
INA	GYE 45 KRRB - 210
NSK	UC X09
NTN	UC X09 D 1
SEALMASTER	5309

Figure MU 32
Heavy Duty Spherical Outside Surface Ball Bearings
Set Screws Type

1.7500 in	ID	44.45 mm
3.9370 in	OD	100.00 mm
2.2441 in	IW	57.00 mm

Group No. IB 0164 - 1

SLB	UC 309 - 28
ASAHI	UC 309 - 28
FYH	UC 309 - 28
NSK	UC 309 - 28 S
NTN	UC 309 - 112 D 1

Figure MU 34
Standard Duty Spherical Outside Surface Ball Bearings
Eccentric Locking Collar Type

1.7717 in	ID	45.00 mm
3.3465 in	OD	85.00 mm
2.2165 in	IW	56.30 mm

Group No. IB 0167 - 1

SLB	UEL 209
ASAHI	UG 209 + ER
FAFNIR	GE 45 KRRB
FAG	36209 B
FYH	NA 209
INA	GE 45 KRRB
KOYO	GA 1112 M 2 RSB
NACHI	UG 209 + ER
NSK	EW 209
NTN	UEL 209 D 1 W 3
RHP	1045 - 45 DECG
SKF	YEL 209

Figure MU 32
Heavy Duty Spherical Outside Surface Ball Bearings
Set Screws Type

1.7717 in	ID	45.00 mm
3.9370 in	OD	100.00 mm
2.2441 in	IW	57.00 mm

Group No. IB 0170 - 1

SLB	UC 309
ASAHI	UC 309
FYH	UC 309
NSK	UC 309
NTN	UC 309 D 1

Figure MU 31
Standard Duty Spherical Outside Surface Ball Bearings
Set Screws Type

1.7717 in	ID	45.00 mm
3.3465 in	OD	85.00 mm
1.9370 in	IW	49.20 mm

Group No. IB 0165 - 1

SLB	UC 209
ASAHI	UC 209
FAG	56209
FYH	UC 209
INA	GYE 45 KRRB
KOYO	UC 209
NACHI	UC 209
NSK	UC 209
NTN	UC 209 D 1
RHP	1045 - 45 G
SEALMASTER	5209
SKF	YAR 209
SNR	1045 - 45 G

Figure MU 35
Standard Duty Spherical Outside Surface Ball Bearings
Adapter Type

1.7717 in	ID	45.00 mm
3.5433 in	OD	90.00 mm
1.2205 in	IW	31.00 mm

Group No. IB 0168 - 1

SLB	UK 210
ASAHI	UK 210
FYH	UK 210
NACHI	UK 210
NSK	UK 210
NTN	UK 210 D 1
RHP	1050 - 45 KG

Figure MU 31
Standard Duty Spherical Outside Surface Ball Bearings
Set Screws Type

1.8125 in	ID	46.04 mm
3.5433 in	OD	90.00 mm
2.0315 in	IW	51.60 mm

Group No. IB 0171 - 1

SLB	UC 210 - 29
NSK	UC 210 - 29 S
NTN	UC 210 - 113 D 1
SEALMASTER	2 - 113

Figure MU 29
Standard Duty Spherical Outside Surface Ball Bearings
Eccentric Locking Collar Type

1.7717 in	ID	45.00 mm
3.3465 in	OD	85.00 mm
1.6614 in	IW	42.20 mm

Group No. IB 0166 - 1

SLB	SA 209
ASAHI	KH 209 BE
FAFNIR	GRAE 45 RRB
FAG	16209
INA	GRAE 45 NPPB

Figure MU 33
Medium Duty Spherical Outside Surface Ball Bearings
Set Screws Type

1.7717 in	ID	45.00 mm
3.5433 in	OD	90.00 mm
2.0315 in	IW	51.60 mm

Group No. IB 0169 - 1

SLB	UC X09
ASAHI	UC X09

Figure MU 29
Standard Duty Spherical Outside Surface Ball Bearings
Eccentric Locking Collar Type

1.8125 in	ID	46.04 mm
3.5433 in	OD	90.00 mm
1.7205 in	IW	43.70 mm

Group No. IB 0172 - 1

SLB	SA 210 - 29
FAFNIR	GRA 113 RRB
NSK	EN 210 - 29 S

Figure MU 34
Standard Duty Spherical Outside Surface Ball Bearings
Eccentric Locking Collar Type

1.8125 in	ID	46.04 mm
3.5433 in	OD	90.00 mm
2.4685 in	IW	62.70 mm

Group No. IB 0173 - 1		
SLB	UEL 210 - 29	
FAFNIR	G 1113 KRRB	
NSK	EW 210 - 29 S	
NTN	UEL 210 - 113 D 1 W 3	

Figure MU 33
Medium Duty Spherical Outside Surface Ball Bearings
Set Screws Type

1.8125 in	ID	46.04 mm
3.9370 in	OD	100.00 mm
2.1890 in	IW	55.60 mm

Group No. IB 0174 - 1		
SLB	UC X10 - 29	
NSK	UC X10 - 29 S	

Figure MU 32
Heavy Duty Spherical Outside Surface Ball Bearings
Set Screws Type

1.8125 in	ID	46.04 mm
4.3307 in	OD	110.00 mm
2.4016 in	IW	61.00 mm

Group No. IB 0175 - 1		
SLB	UC 310 - 29	
NSK	UC 310 - 29 S	
NTN	UC 310 - 113 D 1	

Figure MU 31
Standard Duty Spherical Outside Surface Ball Bearings
Set Screws Type

1.8750 in	ID	47.63 mm
3.5433 in	OD	90.00 mm
2.0315 in	IW	51.60 mm

Group No. IB 0176 - 1		
SLB	UC 210 - 30	
ASAHI	UC 210 - 30	
FYH	UC 210 - 30	
KOYO	UC 210 - 30	
NACHI	UC 210 - 30	
NSK	UC 210 - 30 S	
NTN	UC 210 - 114 D 1	
RHP	1050 - 1 7/8 G	
SEALMASTER	2 - 114	
SKF	YAR 210 - 114	

Figure MU 29
Standard Duty Spherical Outside Surface Ball Bearings
Eccentric Locking Collar Type

1.8750 in	ID	47.63 mm
3.5433 in	OD	90.00 mm
1.7205 in	IW	43.70 mm

Group No. IB 0177 - 1		
SLB	SA 210 - 30	
ASAHI	KH 210 - 30 BE	
FAFNIR	GRA 114 RRB	
KOYO	GARA 114 2 RSA	
NACHI	KH 210 - 30 BE	
NSK	EN 210 - 30 S	
RHP	1250 - 1 7/8 ECG	
SKF	YET 210 - 114	

Figure MU 34
Standard Duty Spherical Outside Surface Ball Bearings
Eccentric Locking Collar Type

1.8750 in	ID	47.63 mm
3.5433 in	OD	90.00 mm
2.4685 in	IW	62.70 mm

Group No. IB 0178 - 1		
SLB	UEL 210 - 30	
ASAHI	UG 210 - 30 + ER	
FAFNIR	G 1114 KRRB	
KOYO	GA 1114 2 RSB	
NACHI	UG 210 - 30 + ER	
NSK	EW 210 - 30 S	
NTN	UEL 210 - 114 D 1 W 3	
RHP	1050 - 1 7/8 DECG	
SKF	YEL 210 - 114	

Figure MU 33
Medium Duty Spherical Outside Surface Ball Bearings
Set Screws Type

1.8750 in	ID	47.63 mm
3.9370 in	OD	100.00 mm
2.1890 in	IW	55.60 mm

Group No. IB 0179 - 1		
SLB	UC X10 - 30	
ASAHI	UC X10 - 30	
NSK	UC X10 - 30 S	
NTN	UC X10 - 114 D 1	

Figure MU 32
Heavy Duty Spherical Outside Surface Ball Bearings
Set Screws Type

1.8750 in	ID	47.63 mm
4.3307 in	OD	110.00 mm
2.4016 in	IW	61.00 mm

Group No. IB 0180 - 1		
SLB	UC 310 - 30	
ASAHI	UC 310 - 30	
NSK	UC 310 - 30 S	
NTN	UC 310 - 114 D 1	

Figure MU 31
Standard Duty Spherical Outside Surface Ball Bearings
Set Screws Type

1.9375 in	ID	49.21 mm
3.5433 in	OD	90.00 mm
2.0315 in	IW	51.60 mm

Group No. IB 0181 - 1		
SLB	UC 210 - 31	
ASAHI	UC 210 - 31	
BROWNING	VS - 231	
FAG	56210.115	
FYH	UC 210 - 31	
INA	GY 1115 KRRB	
KOYO	UC 210 - 31	
LINK - BELT	UG 231 NL	
NACHI	UC 210 - 31	
NSK	UC 210 - 31 S	
NTN	UC 210 - 115 D 1	
RHP	1050 - 1 15/16 G	
SEALMASTER	2 - 115	
SKF	YAR 210 - 115	

Figure MU 29
Standard Duty Spherical Outside Surface Ball Bearings
Eccentric Locking Collar Type

1.9375 in	ID	49.21 mm
3.5433 in	OD	90.00 mm
1.7205 in	IW	43.70 mm

Group No. IB 0182 - 1		
SLB	SA 210 - 31	
ASAHI	KH 210 - 31 BE	
FAFNIR	GRA 115 RRB	
INA	GRA 115 NPPB	
KOYO	GARA 115 2 RSA	
LINK - BELT	WG 231 UL	
NACHI	KH 210 - 31 BE	
NSK	EN 210 - 31 S	
RHP	1250 - 1 15/16 ECG	
SEALMASTER	V - 31 E	
SKF	YET 210 - 115	

Figure MU 34
Standard Duty Spherical Outside Surface Ball Bearings
Eccentric Locking Collar Type

1.9375 in	ID	49.21 mm
3.5433 in	OD	90.00 mm
2.4685 in	IW	62.70 mm

Group No. IB 0183 - 1		
SLB	UEL 210 - 31	
ASAHI	UG 210 - 31 + ER	
BROWNING	VE - 231	
FAFNIR	G 1115 KRRB	

FYH	NA 210 - 31
INA	G 1115 KRRB
KOYO	GA 1115 2 RSB
LINK - BELT	YG 231 NL
NACHI	UG 210 - 31 + ER
NSK	EW 210 - 31 S
NTN	UEL 210 - 115 D 1 W 3
RHP	1050 - 1 15/16 DECG
SKF	YEL 210 - 115

LINK - BELT	UG 2 M 50 NL
NACHI	UC 210
NSK	UC 210
NTN	UC 210 D 1
RHP	1050 - 50 G
SEALMASTER	5210
SKF	YAR 210
SNR	1050 - 50 G

Group No. IB 0189 - 1	
SLB	UK 211
ASAHI	UK 211
FYH	UK 211
NACHI	UK 211
NSK	UK 211
NTN	UK 211 D 1
RHP	1055 - 50 KG

Figure MU 33
Medium Duty Spherical Outside Surface Ball Bearings
Set Screws Type

1.9375 in	ID	49.21 mm
3.9370 in	OD	100.00 mm
2.1890 in	IW	55.60 mm

Group No. IB 0184 - 1	
SLB	UC X10 - 31
ASAHI	UC X10 - 31
BROWNING	VS - 331
FYH	UC X10 - 31
NSK	UC X10 - 31 S
NTN	UC X10 - 115 D 1
SEALMASTER	3 - 115
SKF	YAR 211 - 115

Figure MU 29
Standard Duty Spherical Outside Surface Ball Bearings
Eccentric Locking Collar Type

1.9685 in	ID	50.00 mm
3.5433 in	OD	90.00 mm
1.7205 in	IW	43.70 mm

Group No. IB 0187 - 1	
SLB	SA 210
ASAHI	KH 210 BE
FAFNIR	GRAE 50 RRB
FAG	16210
INA	GRAE 50 NPPB
KOYO	GARA 115 M 2 RSA
NACHI	KH 210 BE
NSK	EN 210
RHP	1250 - 50 ECG
SKF	YET 210
SNR	1250 - 50 ECG

Figure MU 33
Medium Duty Spherical Outside Surface Ball Bearings
Set Screws Type

1.9685 in	ID	50.00 mm
3.9370 in	OD	100.00 mm
2.1890 in	IW	55.60 mm

Group No. IB 0190 - 1	
SLB	UC X10
ASAHI	UC X10
FYH	UC X10
INA	GYE 50 KRRB - 211
NSK	UC X10
NTN	UC X10 D 1
SEALMASTER	5310

Figure MU 32
Heavy Duty Spherical Outside Surface Ball Bearings
Set Screws Type

1.9375 in	ID	49.21 mm
4.3307 in	OD	110.00 mm
2.4016 in	IW	61.00 mm

Group No. IB 0185 - 1	
SLB	UC 310 - 31
FYH	UC 310 - 31
NSK	UC 310 - 31 S
NTN	UC 310 - 115 D 1

Figure MU 34
Standard Duty Spherical Outside Surface Ball Bearings
Eccentric Locking Collar Type

1.9685 in	ID	50.00 mm
3.5433 in	OD	90.00 mm
2.4685 in	IW	62.70 mm

Group No. IB 0188 - 1	
SLB	UEL 210
ASAHI	UG 210 + ER
FAFNIR	GE 50 KRRB
FAG	36210 B
FYH	NA 210
INA	GE 50 KRRB
KOYO	GA 1115 M 2 RSB
NACHI	UG 210 + ER
NSK	EW 210
NTN	UEL 210 D 1 W 3
RHP	1050 - 50 DECG
SKF	YEL 210

Figure MU 32
Heavy Duty Spherical Outside Surface Ball Bearings
Set Screws Type

1.9685 in	ID	50.00 mm
4.3307 in	OD	110.00 mm
2.4016 in	IW	61.00 mm

Group No. IB 0191 - 1	
SLB	UC 310
ASAHI	UC 310
FYH	UC 310
INA	GNYE 50 KRRB
NSK	UC 310
NTN	UC 310 D 1

Figure MU 31
Standard Duty Spherical Outside Surface Ball Bearings
Set Screws Type

1.9685 in	ID	50.00 mm
3.5433 in	OD	90.00 mm
2.0315 in	IW	51.60 mm

Group No. IB 0186 - 1	
SLB	UC 210
ASAHI	UC 210
FAG	56210
FYH	UC 210
INA	GYE 50 KRRB
KOYO	UC 210

Figure MU 35
Standard Duty Spherical Outside Surface Ball Bearings
Adapter Type

1.9685 in	ID	50.00 mm
3.9370 in	OD	100.00 mm
1.2992 in	IW	33.00 mm

Figure MU 31
Standard Duty Spherical Outside Surface Ball Bearings
Set Screws Type

2.0000 in	ID	50.80 mm
3.5433 in	OD	90.00 mm
2.0315 in	IW	51.60 mm

Group No. IB 0192 - 1	
SLB	UC 210 - 32
BROWNING	VS - 232 S
LINK - BELT	UG 2 E 32 NL
NSK	UC 210 - 32 S
NTN	UC 210 - 200 D 1
RHP	1050 - 2 G
SEALMASTER	2000 - 1 - 2

Figure MU 31
Standard Duty Spherical Outside Surface Ball Bearings
Set Screws Type

2.0000 in	ID	50.80 mm
3.9370 in	OD	100.00 mm
2.1890 in	IW	55.60 mm

Group No. IB 0193 - 1

SLB	SA 210 - 32
LINK - BELT	WG 2 E 32 UL
NSK	EN 210 - 32 S
RHP	1250 - 2 ECG
SEALMASTER	V - 31 RE

Figure MU 29
Standard Duty Spherical Outside Surface Ball Bearings
Eccentric Locking Collar Type

2.0000 in	ID	50.80 mm
3.5433 in	OD	90.00 mm
1.7205 in	IW	43.70 mm

Group No. IB 0194 - 1

SLB	UEL 210 - 32
LINK - BELT	YG 2 E 32 NL
NSK	EW 210 - 32 S
NTN	UEL 210 - 200 D 1 W 3

Figure MU 29
Standard Duty Spherical Outside Surface Ball Bearings
Eccentric Locking Collar Type

2.0000 in	ID	50.80 mm
3.9370 in	OD	100.00 mm
1.9055 in	IW	48.40 mm

Group No. IB 0195 - 1

SLB	UC X10 - 32
ASAHI	UC X10 - 32
BROWNING	VS - 332
FYH	UC X10 - 32
INA	GY 1200 KRRB
NSK	UC X10 - 32 S

Figure MU 34
Standard Duty Spherical Outside Surface Ball Bearings
Eccentric Locking Collar Type

2.0000 in	ID	50.80 mm
3.5433 in	OD	90.00 mm
2.4685 in	IW	62.70 mm

Group No. IB 0196 - 1

SLB	UC 310 - 32
NSK	UC 310 - 32 S

Figure MU 34
Standard Duty Spherical Outside Surface Ball Bearings
Eccentric Locking Collar Type

2.0000 in	ID	50.80 mm
3.9370 in	OD	100.00 mm
2.8071 in	IW	71.30 mm

Group No. IB 0197 - 1

SLB	UC 211 - 32
ASAHI	UC 211 - 32
BROWNING	VS - 332
FAG	56211.200
FYH	UC 211 - 32
INA	GY 1200 KRRB
KOYO	UC 211 - 32
LINK - BELT	UG 232 NL
NACHI	UC 211 - 32
NSK	UC 211 - 32 S
NTN	UC 211 - 200 D 1
RHP	1055 - 2G
SEALMASTER	2000 - 2 - 2
SKF	YAR 211 - 200

Figure MU 33
Medium Duty Spherical Outside Surface Ball Bearings
Set Screws Type

2.0000 in	ID	50.80 mm
3.9370 in	OD	100.00 mm
2.1890 in	IW	55.60 mm

Group No. IB 0198 - 1

SLB	SA 211 - 32
ASAHI	KH 211 - 32 BE
FAFNIR	GRA 200 RRB
INA	GRA 200 NPPB
KOYO	GARA 200 2 RSA
NACHI	KH 211 - 32 BE
NSK	EN 211 - 32 S
SEALMASTER	V - 32 E
SKF	YET 211 - 200

Figure MU 33
Medium Duty Spherical Outside Surface Ball Bearings
Set Screws Type

2.0000 in	ID	50.80 mm
4.3307 in	OD	110.00 mm
2.5630 in	IW	65.10 mm

Group No. IB 0199 - 1

SLB	UEL 211 - 32
ASAHI	UG 211 - 32 + ER
BROWNING	VE - 232
FAFNIR	G 1200 KRRB
FYH	NA 211 - 32
LINK - BELT	YG 232 NL

NACHI	UG 211 - 32 + ER
NSK	EW 211 - 32 S
NTN	UEL 211 - 200 D 1 W 3
RHP	1055 - 2 DECG
SKF	YEL 211 - 200

Figure MU 32
Heavy Duty Spherical Outside Surface Ball Bearings
Set Screws Type

2.0000 in	ID	50.80 mm
4.3307 in	OD	110.00 mm
2.4016 in	IW	61.00 mm

Group No. IB 0200 - 1

SLB	UC X11 - 32
NSK	UC X11 - 32 S

Figure MU 32
Heavy Duty Spherical Outside Surface Ball Bearings
Set Screws Type

2.0000 in	ID	50.80 mm
4.7244 in	OD	120.00 mm
2.5984 in	IW	66.00 mm

Group No. IB 0201 - 1

SLB	UC 311 - 32
ASAHI	UC 311 - 32
FYH	UC 311 - 32
NSK	UC 311 - 32 S
NTN	UC 311 - 200 D 1

Figure MU 31
Standard Duty Spherical Outside Surface Ball Bearings
Set Screws Type

2.0625 in	ID	52.39 mm
3.9370 in	OD	100.00 mm
2.1890 in	IW	55.60 mm

Group No. IB 0202 - 1

SLB	UC 211 - 33
ASAHI	UC 211 - 33
NACHI	UC 211 - 33
NSK	UC 211 - 33 S
NTN	UC 211 - 201 D 1

Figure MU 29
Standard Duty Spherical Outside Surface Ball Bearings
Eccentric Locking Collar Type

2.0625 in	ID	52.39 mm
3.9370 in	OD	100.00 mm
1.9055 in	IW	48.40 mm

Group No. IB 0203 - 1		
SLB	SA 211 - 33	
FAFNIR	GRA 201 RRB	
NSK	EN 211 - 33 S	

Figure MU 34
Standard Duty Spherical Outside Surface Ball Bearings
Eccentric Locking Collar Type

2.0625 in	ID	52.39 mm
3.9370 in	OD	100.00 mm
2.8071 in	IW	71.30 mm

Group No. IB 0204 - 1		
SLB	UEL 211 - 33	
FAFNIR	G 1201 KRRB	
NSK	EW 211 - 33 S	
NTN	UEL 211 - 201 D 1 W 3	

Figure MU 33
Medium Duty Spherical Outside Surface Ball Bearings
Set Screws Type

2.0625 in	ID	52.39 mm
4.3307 in	OD	110.00 mm
2.5630 in	IW	65.10 mm

Group No. IB 0205 - 1		
SLB	UC X11 - 33	
NSK	UC X11 - 33 S	
NTN	UC X11 - 201 D 1	

Figure MU 32
Heavy Duty Spherical Outside Surface Ball Bearings
Set Screws Type

2.0625 in	ID	52.39 mm
4.7244 in	OD	120.00 mm
2.5984 in	IW	66.00 mm

Group No. IB 0206 - 1		
SLB	UC 311 - 33	
NSK	UC 311 - 33 S	
NTN	UC 311 - 201 D 1	

Figure MU 31
Standard Duty Spherical Outside Surface Ball Bearings
Set Screws Type

2.1250 in	ID	53.98 mm
3.9370 in	OD	100.00 mm
2.1890 in	IW	55.60 mm

Group No. IB 0207 - 1		
SLB	UC 211 - 34	
ASAHI	UC 211 - 34	

FYH	UC 211 - 34
NACHI	UC 211 - 34
NSK	UC 211 - 34 S
NTN	UC 211 - 202 D 1
RHP	1055 - 2 1/8 G
SEALMASTER	2000 - 2 - 22

Figure MU 29
Standard Duty Spherical Outside Surface Ball Bearings
Eccentric Locking Collar Type

2.1250 in	ID	53.98 mm
3.9370 in	OD	100.00 mm
1.9055 in	IW	48.40 mm

Group No. IB 0208 - 1		
SLB	SA 211 - 34	
ASAHI	KH 211 - 34 BE	
FAFNIR	GRA 202 RRB	
NACHI	KH 211 - 34 BE	
NSK	EN 211 - 34 S	

Figure MU 34
Standard Duty Spherical Outside Surface Ball Bearings
Eccentric Locking Collar Type

2.1250 in	ID	53.98 mm
3.9370 in	OD	100.00 mm
2.8071 in	IW	71.30 mm

Group No. IB 0209 - 1		
SLB	UEL 211 - 34	
ASAHI	UG 211 - 34 + ER	
FAFNIR	G 1202 KRRB	
NACHI	UG 211 - 34 + ER	
NSK	EW 211 - 34 S	
NTN	UEL 211 - 202 D 1 W 3	
RHP	1055 - 2 1/8 DECG	

Figure MU 33
Medium Duty Spherical Outside Surface Ball Bearings
Set Screws Type

2.1250 in	ID	53.98 mm
4.3307 in	OD	110.00 mm
2.5630 in	IW	65.10 mm

Group No. IB 0210 - 1		
SLB	UC X11 - 34	
ASAHI	UC X11 - 34	
NSK	UC X11 - 34 S	
NTN	UC X11 - 202 D 1	

Figure MU 32
Heavy Duty Spherical Outside Surface Ball Bearings
Set Screws Type

2.1250 in	ID	53.98 mm
4.7244 in	OD	120.00 mm
2.5984 in	IW	66.00 mm

Group No. IB 0211 - 1		
SLB	UC 311 - 34	
ASAHI	UC 311 - 34	
NSK	UC 311 - 34 S	
NTN	UC 311 - 202 D 1	

Figure MU 31
Standard Duty Spherical Outside Surface Ball Bearings
Set Screws Type

2.1654 in	ID	55.00 mm
3.9370 in	OD	100.00 mm
2.1890 in	IW	55.60 mm

Group No. IB 0212 - 1		
SLB	UC 211	
ASAHI	UC 211	
FAG	56211	
FYH	UC 211	
INA	GYE 55 KRRB	
KOYO	UC 211	
LINK - BELT	UG 2 M 55 NL	
NACHI	UC 211	
NSK	UC 211	
NTN	UC 211 D 1	
RHP	1055 - 55 G	
SEALMASTER	5211	
SKF	YAR 211	
SNR	1055 - 55 G	

Figure MU 29
Standard Duty Spherical Outside Surface Ball Bearings
Eccentric Locking Collar Type

2.1654 in	ID	55.00 mm
3.9370 in	OD	100.00 mm
1.9055 in	IW	48.40 mm

Group No. IB 0213 - 1		
SLB	SA 211	
ASAHI	KH 211 BE	
FAFNIR	GRAE 55 RRB	
INA	GRAE 55 NPPB	
KOYO	GARA 203 M 2 RSA	
NACHI	KH 211 BE	
NSK	EN 211	
SKF	YET 211	

Figure MU 34
Standard Duty Spherical Outside Surface Ball Bearings
Eccentric Locking Collar Type

2.1654 in	ID	55.00 mm
3.9370 in	OD	100.00 mm
2.8071 in	IW	71.30 mm

Group No. IB 0214 - 1	
SLB	UEL 211
ASAHI	UG 211 + ER
FAFNIR	GE 55 KRRB
FYH	NA 211
INA	GE 55 KRRB
KOYO	GA 1203 M 2 RSB
NACHI	UG 211 + ER
NSK	EW 211
NTN	UEL 211 D 1 W 3
RHP	1055 - 55 DECG
SKF	YEL 211

Figure MU 35
Standard Duty Spherical Outside Surface Ball Bearings
Adapter Type

2.1654 in	ID	55.00 mm
4.3307 in	OD	110.00 mm
1.4173 in	IW	36.00 mm

Group No. IB 0215 - 1	
SLB	UK 212
ASAHI	UK 212
FYH	UK 212
NACHI	UK 212
NSK	UK 212
NTN	UK 212 D 1

Figure MU 33
Medium Duty Spherical Outside Surface Ball Bearings
Set Screws Type

2.1654 in	ID	55.00 mm
4.3307 in	OD	110.00 mm
2.5630 in	IW	65.10 mm

Group No. IB 0216 - 1	
SLB	UC X11
ASAHI	UC X11
FYH	UC X11
NSK	UC X11
NTN	UC X11 D 1
SEALMASTER	5311

Figure MU 32
Heavy Duty Spherical Outside Surface Ball Bearings
Set Screws Type

2.1654 in	ID	55.00 mm
4.7244 in	OD	120.00 mm
2.5984 in	IW	66.00 mm

Group No. IB 0217 - 1	
SLB	UC 311
ASAHI	UC 311
FYH	UC 311
NSK	UC 311
NTN	UC 311 D 1

Figure MU 31
Standard Duty Spherical Outside Surface Ball Bearings
Set Screws Type

2.1875 in	ID	55.56 mm
3.9370 in	OD	100.00 mm
2.1890 in	IW	55.60 mm

Group No. IB 0218 - 1	
SLB	UC 211 - 35
ASAHI	UC 211 - 35
BROWNING	VS - 235
FAG	56211.203
FYH	UC 211 - 35
KOYO	UC 211 - 35
LINK - BELT	UG 235 NL
NACHI	UC 211 - 35
NSK	UC 211 - 35 S
NTN	UC 211 - 203 D 1
RHP	1055 - 2 3/16 G
SEALMASTER	2000 - 2 - 23
SKF	YAR 211 - 203

Figure MU 29
Standard Duty Spherical Outside Surface Ball Bearings
Eccentric Locking Collar Type

2.1875 in	ID	55.56 mm
3.9370 in	OD	100.00 mm
1.9055 in	IW	48.40 mm

Group No. IB 0219 - 1	
SLB	SA 211 - 35
ASAHI	KH 211 - 35 BE
FAFNIR	GRA 203 RRB
INA	GRA 203 NPPB
KOYO	GARA 203 2 RSA
NACHI	KH 211 - 35 BE
NSK	EN 211 - 35 S
SEALMASTER	V - 35 E
SKF	YET 211 - 203

Figure MU 34
Standard Duty Spherical Outside Surface Ball Bearings
Eccentric Locking Collar Type

2.1875 in	ID	55.56 mm
3.9370 in	OD	100.00 mm
2.8071 in	IW	71.30 mm

Group No. IB 0220 - 1	
SLB	UEL 211 - 35
ASAHI	UG 211 - 35 + ER
BROWNING	VE - 235
FAFNIR	G 1203 KRRB
FYH	NA 211 - 35
INA	G 1203 KRRB
LINK - BELT	YG 235 NL
NACHI	UG 211 - 35 + ER

NSK	EW 211 - 35 S
NTN	UEL 211 - 203 D 1 W 3
RHP	1055 - 2 3/16 DECG
SKF	YEL 211 - 203

Figure MU 33
Medium Duty Spherical Outside Surface Ball Bearings
Set Screws Type

2.1875 in	ID	55.56 mm
4.3307 in	OD	110.00 mm
2.5630 in	IW	65.10 mm

Group No. IB 0221 - 1	
SLB	UC X11 - 35
ASAHI	UC X11 - 35
BROWNING	VS - 335
FYH	UC X11 - 35
NSK	UC X11 - 35 S
NTN	UC X11 - 203 D 1
SEALMASTER	2000 - 3 - 23
SKF	YAR 212 - 203

Figure MU 32
Heavy Duty Spherical Outside Surface Ball Bearings
Set Screws Type

2.1875 in	ID	55.56 mm
4.7244 in	OD	120.00 mm
2.5984 in	IW	66.00 mm

Group No. IB 0222 - 1	
SLB	UC 311 - 35
NSK	UC 311 - 35 S
NTN	UC 311 - 203 D 1

Figure MU 31
Standard Duty Spherical Outside Surface Ball Bearings
Set Screws Type

2.2500 in	ID	57.15 mm
4.3307 in	OD	110.00 mm
2.5630 in	IW	65.10 mm

Group No. IB 0223 - 1	
SLB	UC 212 - 36
ASAHI	UC 212 - 36
BROWNING	VS - 336
FAG	56212.204
FYH	UC 212 - 36
KOYO	UC 212 - 36
LINK - BELT	UG 236 NL
NACHI	UC 212 - 36
NSK	UC 212 - 36 S
NTN	UC 212 - 204 D 1
RHP	1060 - 2 1/4 G
SEALMASTER	2000 - 2 - 24
SKF	YAR 212 - 204

Figure MU 34
Standard Duty Spherical Outside Surface Ball Bearings
Eccentric Locking Collar Type

2.2500 in	ID	57.15 mm
4.3307 in	OD	110.00 mm
3.0591 in	IW	77.70 mm

Group No. IB 0224 - 1

SLB	UEL 212 - 36	
ASAHI	UG 212 - 36 + ER	
BROWNING	VE - 236	
FAFNIR	G 1204 KRRB	
FYH	NA 212 - 36	
LINK - BELT	YG 236 NL	
NACHI	UG 212 - 36 + ER	
NSK	EW 212 - 36 S	
NTN	UEL 212 - 204 D 1 W 3	
RHP	1060 - 2 1/4 DECG	
SKF	YEL 212 - 204	

Figure MU 33
Medium Duty Spherical Outside Surface Ball Bearings
Set Screws Type

2.2500 in	ID	57.15 mm
4.7244 in	OD	120.00 mm
2.5630 in	IW	65.10 mm

Group No. IB 0225 - 1

SLB	UC X12 - 36	
ASAHI	UC X12 - 36	
FYH	UC X12 - 36	
NSK	UC X12 - 36 S	

Figure MU 32
Heavy Duty Spherical Outside Surface Ball Bearings
Set Screws Type

2.2500 in	ID	57.15 mm
5.1181 in	OD	130.00 mm
2.7953 in	IW	71.00 mm

Group No. IB 0226 - 1

SLB	UC 312 - 36	
ASAHI	UC 312 - 36	
NSK	UC 312 - 36 S	
NTN	UC 312 - 204 D 1	

Figure MU 31
Standard Duty Spherical Outside Surface Ball Bearings
Set Screws Type

2.3125 in	ID	58.74 mm
4.3307 in	OD	110.00 mm
2.5630 in	IW	65.10 mm

Group No. IB 0227 - 1		
SLB	UC 212 - 37	
NSK	UC 212 - 37 S	
NTN	UC 212 - 205 D 1	

Figure MU 34
Standard Duty Spherical Outside Surface Ball Bearings
Eccentric Locking Collar Type

2.3125 in	ID	58.74 mm
4.3307 in	OD	110.00 mm
3.0591 in	IW	77.70 mm

Group No. IB 0228 - 1

SLB	UEL 212 - 37	
FAFNIR	G 1205 KRRB	
NSK	EW 212 - 37 S	
NTN	UEL 212 - 205 D 1 W 3	

Figure MU 33
Medium Duty Spherical Outside Surface Ball Bearings
Set Screws Type

2.3125 in	ID	58.74 mm
4.7244 in	OD	120.00 mm
2.5630 in	IW	65.10 mm

Group No. IB 0229 - 1

SLB	UC X12 - 37	
NSK	UC X12 - 37 S	

Figure MU 32
Heavy Duty Spherical Outside Surface Ball Bearings
Set Screws Type

2.3125 in	ID	58.74 mm
5.1181 in	OD	130.00 mm
2.7953 in	IW	71.00 mm

Group No. IB 0230 - 1

SLB	UC 312 - 37	
NSK	UC 312 - 37 S	
NTN	UC 312 - 205 D 1	

Figure MU 31
Standard Duty Spherical Outside Surface Ball Bearings
Set Screws Type

2.3622 in	ID	60.00 mm
4.3307 in	OD	110.00 mm
2.5630 in	IW	65.10 mm

Group No. IB 0231 - 1

SLB	UC 212	
ASAHI	UC 212	
FAG	56212	

FYH	UC 212
INA	GYE 60 KRRB
KOYO	UC 212
LINK - BELT	UG 2 M 60 NL
NACHI	UC 212
NSK	UC 212
NTN	UC 212 D 1
RHP	1060 - 60 G
SEALMASTER	5212
SKF	YAR 212
SNR	1060 - 60 G

Figure MU 34
Standard Duty Spherical Outside Surface Ball Bearings
Eccentric Locking Collar Type

2.3622 in	ID	60.00 mm
4.3307 in	OD	110.00 mm
3.0591 in	IW	77.70 mm

Group No. IB 0232 - 1

SLB	UEL 212	
ASAHI	UG 212 + ER	
FAFNIR	GE 60 KRRB	
FYH	NA 212	
INA	GE 60 KRRB	
KOYO	GA 1206 M 2 RSB	
NACHI	UG 212 + ER	
NSK	EW 212	
NTN	UEL 212 D 1 W 3	
RHP	1060 - 60 DECG	
SKF	YEL 212	

Figure MU 35
Standard Duty Spherical Outside Surface Ball Bearings
Adapter Type

2.3622 in	ID	60.00 mm
4.7244 in	OD	120.00 mm
1.4173 in	IW	36.00 mm

Group No. IB 0233 - 1

SLB	UK 213	
ASAHI	UK 213	
FYH	UK 213	
NACHI	UK 213	
NSK	UK 213	
NTN	UK 213 D 1	

Figure MU 33
Medium Duty Spherical Outside Surface Ball Bearings
Set Screws Type

2.3622 in	ID	60.00 mm
4.7244 in	OD	120.00 mm
2.5630 in	IW	65.10 mm

Group No. IB 0234 - 1	
SLB	UC X12
ASAHI	UC X12
FYH	UC X12
NSK	UC X12
NTN	UC X12 D 1

Figure MU 32	
<i>Heavy Duty Spherical Outside Surface Ball Bearings</i>	
<i>Set Screws Type</i>	
2.3622 in	ID 60.00 mm
5.1181 in	OD 130.00 mm
2.7953 in	IW 71.00 mm

Group No. IB 0235 - 1	
SLB	UC 312
ASAHI	UC 312
FYH	UC 312
INA	GNYE 60 KRRB
NSK	UC 312
NTN	UC 312 D 1

Figure MU 31	
<i>Standard Duty Spherical Outside Surface Ball Bearings</i>	
<i>Set Screws Type</i>	
2.3750 in	ID 60.33 mm
4.3307 in	OD 110.00 mm
2.5630 in	IW 65.10 mm

Group No. IB 0236 - 1	
SLB	UC 212 - 38
ASAHI	UC 212 - 38
FYH	UC 212 - 38
LINK - BELT	UG 238 NL
NACHI	UC 212 - 38
NSK	UC 212 - 38 S
NTN	UC 212 - 206 D 1
RHP	1060 - 2 3/8 G
SEALMASTER	2000 - 2 - 26

Figure MU 34	
<i>Standard Duty Spherical Outside Surface Ball Bearings</i>	
<i>Eccentric Locking Collar Type</i>	
2.3750 in	ID 60.33 mm
4.3307 in	OD 110.00 mm
3.0591 in	IW 77.70 mm

Group No. IB 0237 - 1	
SLB	UEL 212 - 38
ASAHI	UG 212 - 38 + ER
FAFNIR	G 1206 KRRB
LINK - BELT	YG 238 NL
NACHI	UG 212 - 38 + ER
NSK	EW 212 - 38 S
NTN	UEL 212 - 206 D 1 W 3
RHP	1060 - 2 3/8 DECG

Figure MU 33		
<i>Medium Duty Spherical Outside Surface Ball Bearings</i>		
<i>Set Screws Type</i>		
2.3750 in	ID	60.33 mm
4.7244 in	OD	120.00 mm
2.5630 in	IW	65.10 mm

Group No. IB 0238 - 1	
SLB	UC X12 - 38
ASAHI	UC X12 - 38
FYH	UC X12 - 38
NSK	UC X12 - 38 S
NTN	UC X12 - 206 D 1

Figure MU 32		
<i>Heavy Duty Spherical Outside Surface Ball Bearings</i>		
<i>Set Screws Type</i>		
2.3750 in	ID	60.33 mm
5.1181 in	OD	130.00 mm
2.7953 in	IW	71.00 mm

Group No. IB 0239 - 1	
SLB	UC 312 - 38
ASAHI	UC 312 - 38
NSK	UC 312 - 38 S
NTN	UC 312 - 206 D 1

Figure MU 31		
<i>Standard Duty Spherical Outside Surface Ball Bearings</i>		
<i>Set Screws Type</i>		
2.4375 in	ID	61.91 mm
4.3307 in	OD	110.00 mm
2.5630 in	IW	65.10 mm

Group No. IB 0240 - 1	
SLB	UC 212 - 39
ASAHI	UC 212 - 39
BROWNING	VS - 339
FAG	56212.207
FYH	UC 212 - 39
INA	GY 1207 KRRB
KOYO	UC 212 - 39
LINK - BELT	UG 239 NL
NACHI	UC 212 - 39
NSK	UC 212 - 39 S
NTN	UC 212 - 207 D 1
RHP	1060 - 2 7/16 G
SEALMASTER	2000 - 2 - 27
SKF	YAR 212 - 207

Figure MU 34	
<i>Standard Duty Spherical Outside Surface Ball Bearings</i>	
<i>Eccentric Locking Collar Type</i>	

2.4375 in	ID	61.91 mm
4.3307 in	OD	110.00 mm
3.0591 in	IW	77.70 mm

Group No. IB 0241 - 1	
SLB	UEL 212 - 39
ASAHI	UG 212 - 39 + ER
BROWNING	VE - 239
FAFNIR	G 1207 KRRB
FYH	NA 212 - 39
INA	G 1207 KRRB
LINK - BELT	YG 239 NL
NACHI	UG 212 - 39 + ER
NSK	EW 212 - 39 S
NTN	UEL 212 - 207 D 1 W 3
RHP	1060 - 2 7/16 DECG
SKF	YEL 212 - 207

Figure MU 33		
<i>Medium Duty Spherical Outside Surface Ball Bearings</i>		
<i>Set Screws Type</i>		
2.4375 in	ID	61.91 mm
4.7244 in	OD	120.00 mm
2.5630 in	IW	65.10 mm

Group No. IB 0242 - 1	
SLB	UC X12 - 39
ASAHI	UC X12 - 39
FYH	UC X12 - 39
NSK	UC X12 - 39 S
NTN	UC X12 - 207 D 1
SEALMASTER	2000 - 3 - 27

Figure MU 32		
<i>Heavy Duty Spherical Outside Surface Ball Bearings</i>		
<i>Set Screws Type</i>		
2.4375 in	ID	61.91 mm
5.1181 in	OD	130.00 mm
2.7953 in	IW	71.00 mm

Group No. IB 0243 - 1	
SLB	UC 312 - 39
NSK	UC 312 - 39 S
NTN	UC 312 - 207 D 1

Figure MU 31		
<i>Standard Duty Spherical Outside Surface Ball Bearings</i>		
<i>Set Screws Type</i>		
2.5000 in	ID	63.50 mm
4.7244 in	OD	120.00 mm
2.5630 in	IW	65.10 mm

Group No. IB 0244 - 1	
SLB	UC 213 - 40
ASAHI	UC 213 - 40

FYH	UC 213 - 40
INA	GY 1208 KRRB - 213
KOYO	UC 213 - 40
NACHI	UC 213 - 40
NSK	UC 213 - 40 S
NTN	UC 213 - 208 D 1
RHP	1065 - 2 1/2 G
SKF	YAR 213 - 208

Figure MU 34
Standard Duty Spherical Outside Surface Ball Bearings
Eccentric Locking Collar Type

2.5000 in	ID	63.50 mm
4.7244 in	OD	120.00 mm
3.3740 in	IW	85.70 mm

Group No. IB 0245 - 1

SLB	UEL 213 - 40
FYH	NA 213 - 40
NSK	EW 213 - 40 S
NTN	UEL 213 - 208 D 1 W 3
RHP	1065 - 2 1/2 DECG

Figure MU 33
Medium Duty Spherical Outside Surface Ball Bearings
Set Screws Type

2.5000 in	ID	63.50 mm
4.9213 in	OD	125.00 mm
2.9370 in	IW	74.60 mm

Group No. IB 0246 - 1

SLB	UC X13 - 40
ASAHI	UC X13 - 40
FYH	UC X13 - 40
INA	GY 1208 KRRB
NSK	UC X13 - 40 S
NTN	UC X13 - 208 D 1
SKF	YAR 214 - 208

Figure MU 32
Heavy Duty Spherical Outside Surface Ball Bearings
Set Screws Type

2.5000 in	ID	63.50 mm
5.5118 in	OD	140.00 mm
2.9528 in	IW	75.00 mm

Group No. IB 0247 - 1

SLB	UC 313 - 40
ASAHI	UC 313 - 40
FYH	UC 313 - 40
NSK	UC 313 - 40 S
NTN	UC 313 - 208 D 1

Figure MU 31
Standard Duty Spherical Outside Surface Ball Bearings
Set Screws Type

2.5591 in	ID	65.00 mm
4.7244 in	OD	120.00 mm
2.5630 in	IW	65.10 mm

Group No. IB 0248 - 1

SLB	UC 213
ASAHI	UC 213
FYH	UC 213
INA	GYE 65 KRRB - 213
KOYO	UC 213
NACHI	UC 213
NSK	UC 213
NTN	UC 213 D 1
RHP	1065 - 65 G
SKF	YAR 213

Figure MU 34
Standard Duty Spherical Outside Surface Ball Bearings
Eccentric Locking Collar Type

2.5591 in	ID	65.00 mm
4.7244 in	OD	120.00 mm
3.3740 in	IW	85.70 mm

Group No. IB 0249 - 1

SLB	UEL 213
NSK	EW 213
NTN	UEL 213 D 1 W 3

Figure MU 33
Medium Duty Spherical Outside Surface Ball Bearings
Set Screws Type

2.5591 in	ID	65.00 mm
4.9213 in	OD	125.00 mm
2.9370 in	IW	74.60 mm

Group No. IB 0250 - 1

SLB	UC X13
ASAHI	UC X13
FYH	UC X13
INA	GYE 65 KRRB
NSK	UC X13
NTN	UC X13 D 1

Figure MU 32
Heavy Duty Spherical Outside Surface Ball Bearings
Set Screws Type

2.5591 in	ID	65.00 mm
5.5118 in	OD	140.00 mm
2.9528 in	IW	75.00 mm

Group No. IB 0251 - 1	
SLB	UC 313
ASAHI	UC 313
FYH	UC 313
NSK	UC 313
NTN	UC 313 D 1

Figure MU 31
Standard Duty Spherical Outside Surface Ball Bearings
Set Screws Type

2.5625 in	ID	65.09 mm
4.7244 in	OD	120.00 mm
2.5630 in	IW	65.10 mm

Group No. IB 0252 - 1

SLB	UC 213 - 41
NTN	UC 213 - 209 D 1

Figure MU 34
Standard Duty Spherical Outside Surface Ball Bearings
Eccentric Locking Collar Type

2.5625 in	ID	65.09 mm
4.7244 in	OD	120.00 mm
3.3740 in	IW	85.70 mm

Group No. IB 0253 - 1

SLB	UEL 213 - 41
NTN	UEL 213 - 209 D 1 W 3

Figure MU 33
Medium Duty Spherical Outside Surface Ball Bearings
Set Screws Type

2.5625 in	ID	65.09 mm
4.9213 in	OD	125.00 mm
2.9370 in	IW	74.60 mm

Group No. IB 0254 - 1

SLB	UC X13 - 41
NTN	UC X13 - 209 D 1

Figure MU 32
Heavy Duty Spherical Outside Surface Ball Bearings
Set Screws Type

2.5625 in	ID	65.09 mm
5.5118 in	OD	140.00 mm
2.9528 in	IW	75.00 mm

Group No. IB 0255 - 1

SLB	UC 313 - 41
NTN	UC 313 - 209 D 1

Figure MU 31
Standard Duty Spherical Outside Surface Ball Bearings
Set Screws Type



2.6250 in	ID	66.68 mm
4.9213 in	OD	125.00 mm
2.9370 in	IW	74.60 mm

Group No. IB 0256 - 1

SLB	UC 214 - 42
NSK	UC 214 - 42 S
NTN	UC 214 - 210 D 1
RHP	1070 - 2 5/8 G

Figure MU 34
Standard Duty Spherical Outside Surface Ball Bearings
Eccentric Locking Collar Type



2.6250 in	ID	66.68 mm
4.9213 in	OD	125.00 mm
3.3740 in	IW	85.70 mm

Group No. IB 0257 - 1

SLB	UEL 214 - 42
NSK	EW 214 - 42 S
NTN	UEL 214 - 210 D 1 W 3
RHP	1070 - 2 5/8 DECG

Figure MU 33
Medium Duty Spherical Outside Surface Ball Bearings
Set Screws Type



2.6250 in	ID	66.68 mm
5.1181 in	OD	130.00 mm
3.0630 in	IW	77.80 mm

Group No. IB 0258 - 1

SLB	UC X14 - 42
NSK	UC X14 - 42 S
NTN	UC X14 - 210 D 1

Figure MU 32
Heavy Duty Spherical Outside Surface Ball Bearings
Set Screws Type



2.6250 in	ID	66.68 mm
5.9055 in	OD	150.00 mm
3.0709 in	IW	78.00 mm

Group No. IB 0259 - 1

SLB	UC 314 - 42
NSK	UC 314 - 42 S
NTN	UC 314 - 210 D 1

Figure MU 31
Standard Duty Spherical Outside Surface Ball Bearings
Set Screws Type



2.6875 in	ID	68.26 mm
4.9213 in	OD	125.00 mm
2.9370 in	IW	74.60 mm

Group No. IB 0260 - 1

SLB	UC 214 - 43
NSK	UC 214 - 43 S
NTN	UC 214 - 211 D 1
RHP	1070 - 2 11/16 G

Figure MU 34
Standard Duty Spherical Outside Surface Ball Bearings
Eccentric Locking Collar Type



2.6875 in	ID	68.26 mm
4.9213 in	OD	125.00 mm
3.3740 in	IW	85.70 mm

Group No. IB 0261 - 1

SLB	UEL 214 - 43
BROWNING	VE - 243
NSK	EW 214 - 43 S
NTN	UEL 214 - 211 D 1 W 3
RHP	1070 - 2 11/16 DECG

Figure MU 33
Medium Duty Spherical Outside Surface Ball Bearings
Set Screws Type



2.6875 in	ID	68.26 mm
5.1181 in	OD	130.00 mm
3.0630 in	IW	77.80 mm

Group No. IB 0262 - 1

SLB	UC X14 - 43
ASAHI	UC X14 - 43
BROWNING	VS - 343
NSK	UC X14 - 43 S
NTN	UC X14 - 211 D 1
SEALMASTER	3 - 211
SKF	YAR 215 - 211

Figure MU 32
Heavy Duty Spherical Outside Surface Ball Bearings
Set Screws Type



2.6875 in	ID	68.26 mm
5.9055 in	OD	150.00 mm
3.0709 in	IW	78.00 mm

Group No. IB 0263 - 1

SLB	UC 314 - 43
NSK	UC 314 - 43 S
NTN	UC 314 - 211 D 1

Figure MU 31
Standard Duty Spherical Outside Surface Ball Bearings
Set Screws Type



2.7500 in	ID	69.85 mm
4.9213 in	OD	125.00 mm
2.9370 in	IW	74.60 mm

Group No. IB 0264 - 1

SLB	UC 214 - 44
ASAHI	UC 214 - 44
FYH	UC 214 - 44
NACHI	UC 214 - 44
NSK	UC 214 - 44 S
NTN	UC 214 - 212 D 1

Figure MU 34
Standard Duty Spherical Outside Surface Ball Bearings
Eccentric Locking Collar Type



2.7500 in	ID	69.85 mm
4.9213 in	OD	125.00 mm
3.3740 in	IW	85.70 mm

Group No. IB 0265 - 1

SLB	UEL 214 - 44
NSK	EW 214 - 44 S
NTN	UEL 214 - 212 D 1 W 3

Figure MU 33
Medium Duty Spherical Outside Surface Ball Bearings
Set Screws Type



2.7500 in	ID	69.85 mm
5.1181 in	OD	130.00 mm
3.0630 in	IW	77.80 mm

Group No. IB 0266 - 1

SLB	UC X14 - 44
ASAHI	UC X14 - 44
FYH	UC X14 - 44
NSK	UC X14 - 44 S
NTN	UC X14 - 212 D 1

Figure MU 32
Heavy Duty Spherical Outside Surface Ball Bearings
Set Screws Type



2.7500 in	ID	69.85 mm
5.9055 in	OD	150.00 mm
3.0709 in	IW	78.00 mm

Group No. IB 0267 - 1

SLB	UC 314 - 44
ASAHI	UC 314 - 44
FYH	UC 314 - 44
NSK	UC 314 - 44 S
NTN	UC 314 - 212 D 1

Figure MU 31
Standard Duty Spherical Outside Surface Ball Bearings
Set Screws Type



2.7559 in	ID	70.00 mm
4.9213 in	OD	125.00 mm
2.9370 in	IW	74.60 mm

Group No. IB 0268 - 1

SLB	UC 214
ASAHI	UC 214
FYH	UC 214
INA	GYE 70 KRRB
KOYO	UC 214
NACHI	UC 214
NSK	UC 214
NTN	UC214 D 1
RHP	1070 - 70 G
SKF	YAR 214
SNR	1070 - 70 G

Figure MU 34

Standard Duty Spherical Outside Surface Ball Bearings
Eccentric Locking Collar Type

2.7559 in	ID	70.00 mm
4.9213 in	OD	125.00 mm
3.3740 in	IW	85.70 mm

Group No. IB 0269 - 1

SLB	UEL 214
NSK	EW 214
NTN	UEL 214 D 1 W 3
RHP	1070 - 70 DECG

Figure MU 33

Medium Duty Spherical Outside Surface Ball Bearings
Set Screws Type

2.7559 in	ID	70.00 mm
5.1181 in	OD	130.00 mm
3.0630 in	IW	77.80 mm

Group No. IB 0270 - 1

SLB	UC X14
ASAHI	UC X14
FYH	UC X14
NSK	UC X14
NTN	UC X14 D 1
SEALMASTER	5314

Figure MU 32

Heavy Duty Spherical Outside Surface Ball Bearings
Set Screws Type

2.7559 in	ID	70.00 mm
5.9055 in	OD	150.00 mm
3.0709 in	IW	78.00 mm

Group No. IB 0271 - 1

SLB	UC 314
ASAHI	UC 314

FYH	UC 314
NSK	UC 314
NTN	UC 314 D 1

Figure MU 31

Standard Duty Spherical Outside Surface Ball Bearings
Set Screws Type

2.8125 in	ID	71.44 mm
5.1181 in	OD	130.00 mm
3.0630 in	IW	77.80 mm

Group No. IB 0272 - 1

SLB	UC 215 - 45
NSK	UC 215 - 45 S
NTN	UC 215 - 213 D 1

Figure MU 34

Standard Duty Spherical Outside Surface Ball Bearings
Eccentric Locking Collar Type

2.8125 in	ID	71.44 mm
5.1181 in	OD	130.00 mm
3.6260 in	IW	92.10 mm

Group No. IB 0273 - 1

SLB	UEL 215 - 45
FAFNIR	G 1213 KRRB
NSK	EW 215 - 45 S
NTN	UEL 215 - 213 D 1 W 3

Figure MU 33

Medium Duty Spherical Outside Surface Ball Bearings
Set Screws Type

2.8125 in	ID	71.44 mm
5.5118 in	OD	140.00 mm
3.2520 in	IW	82.60 mm

Group No. IB 0274 - 1

SLB	UC X15 - 45
NSK	UC X15 - 45 S
NTN	UC X15 - 213 D 1

Figure MU 32

Heavy Duty Spherical Outside Surface Ball Bearings
Set Screws Type

2.8125 in	ID	71.44 mm
6.2992 in	OD	160.00 mm
3.2283 in	IW	82.00 mm

Group No. IB 0275 - 1

SLB	UC 315 - 45
NSK	UC 315 - 45 S
NTN	UC 315 - 213 D 1

Figure MU 31

Standard Duty Spherical Outside Surface Ball Bearings
Set Screws Type

2.8750 in	ID	73.03 mm
5.1181 in	OD	130.00 mm
3.0630 in	IW	77.80 mm

Group No. IB 0276 - 1

SLB	UC 215 - 46
NSK	UC 215 - 46 S
NTN	UC 215 - 214 D 1
RHP	1075 - 2 7/8 G
SEALMASTER	2 - 214

Figure MU 34

Standard Duty Spherical Outside Surface Ball Bearings
Eccentric Locking Collar Type

2.8750 in	ID	73.03 mm
5.1181 in	OD	130.00 mm
3.6260 in	IW	92.10 mm

Group No. IB 0277 - 1

SLB	UEL 215 - 46
FAFNIR	G 1214 KRRB
NSK	EW 215 - 46 S
NTN	UEL 215 - 214 D 1 W 3
RHP	1075 - 2 7/8 DECG

Figure MU 33

Medium Duty Spherical Outside Surface Ball Bearings
Set Screws Type

2.8750 in	ID	73.03 mm
5.5118 in	OD	140.00 mm
3.2520 in	IW	82.60 mm

Group No. IB 0278 - 1

SLB	UC X15 - 46
NSK	UC X15 - 46 S
NTN	UC X15 - 214 D 1

Figure MU 32

Heavy Duty Spherical Outside Surface Ball Bearings
Set Screws Type

2.8750 in	ID	73.03 mm
6.2992 in	OD	160.00 mm
3.2283 in	IW	82.00 mm

Group No. IB 0279 - 1

SLB	UC 315 - 46
NSK	UC 315 - 46 S
NTN	UC 315 - 214 D 1

Figure MU 31 
Standard Duty Spherical Outside Surface Ball Bearings
 Set Screws Type

2.9375 in	ID	74.61 mm
5.1181 in	OD	130.00 mm
3.0630 in	IW	77.80 mm

Group No. IB 0280 - 1

SLB	UC 215 - 47
BROWNING	VS - 247
INA	GY 1215 KRRB
KOYO	UC 215 - 47
NSK	UC 215 - 47 S
NTN	UC 215 - 215 D 1
RHP	1075 - 2 15/16 G
SEALMASTER	2 - 215
SKF	YAR 215 - 215

2.9375 in	ID	74.61 mm
6.2992 in	OD	160.00 mm
3.2283 in	IW	82.00 mm

Group No. IB 0283 - 1

SLB	UC 315 - 47
NSK	UC 315 - 47 S
NTN	UC 315 - 215 D 1

FYH	UC X15
NSK	UC X15
NTN	UC X15 D 1
SEALMASTER	5315

Figure MU 32 
Heavy Duty Spherical Outside Surface Ball Bearings
 Set Screws Type

2.9528 in	ID	75.00 mm
6.2992 in	OD	160.00 mm
3.2283 in	IW	82.00 mm

Group No. IB 0287 - 1

SLB	UC 315
ASAHI	UC 315
FYH	UC 315
NSK	UC 315
NTN	UC 315 D 1

Figure MU 34 
Standard Duty Spherical Outside Surface Ball Bearings
 Eccentric Locking Collar Type

2.9375 in	ID	74.61 mm
5.1181 in	OD	130.00 mm
3.6260 in	IW	92.10 mm

Group No. IB 0281 - 1

SLB	UEL 215 - 47
BROWNING	VE - 247
FAFNIR	G 1215 KRRB
FYH	NA 215 - 47
NSK	EW 215 - 47 S
NTN	UEL 215 - 215 D 1 W 3
RHP	1075 - 2 15/16 DECG

Figure MU 31 
Standard Duty Spherical Outside Surface Ball Bearings
 Set Screws Type

2.9528 in	ID	75.00 mm
5.1181 in	OD	130.00 mm
3.0630 in	IW	77.80 mm

Group No. IB 0284 - 1

SLB	UC 215
ASAHI	UC 215
FYH	UC 215
INA	GYE 75 KRRB
KOYO	UC 215
NACHI	UC 215
NSK	UC 215
NTN	UC 215 D 1
RHP	1075 - 75 G
SEALMASTER	5215
SKF	YAR 215
SNR	1075 - 75 G

Figure MU 31 
Standard Duty Spherical Outside Surface Ball Bearings
 Set Screws Type

3.0000 in	ID	76.20 mm
5.1181 in	OD	130.00 mm
3.0630 in	IW	77.80 mm

Group No. IB 0288 - 1

SLB	UC 215 - 48
ASAHI	UC 215 - 48
FYH	UC 215 - 48
NACHI	UC 215 - 48
NSK	UC 215 - 48 S
NTN	UC 215 - 300 D 1
RHP	1075 - 3 G

Figure MU 33 
Medium Duty Spherical Outside Surface Ball Bearings
 Set Screws Type

2.9375 in	ID	74.61 mm
5.5118 in	OD	140.00 mm
3.2520 in	IW	82.60 mm

Group No. IB 0282 - 1

SLB	UC X15 - 47
ASAHI	UC X15 - 47
BROWNING	VS - 347
NSK	UC X15 - 47 S
NTN	UC X15 - 215 D 1
SEALMASTER	3 - 215
SKF	YAR 216 - 215

Figure MU 34 
Standard Duty Spherical Outside Surface Ball Bearings
 Eccentric Locking Collar Type

2.9528 in	ID	75.00 mm
5.1181 in	OD	130.00 mm
3.6260 in	IW	92.10 mm

Group No. IB 0285 - 1

SLB	UEL 215
FAFNIR	GE 75 KRRB
NSK	EW 215
NTN	UEL 215 D 1 W 3
RHP	1075 - 75 DECG

Figure MU 34 
Standard Duty Spherical Outside Surface Ball Bearings
 Eccentric Locking Collar Type

3.0000 in	ID	76.20 mm
5.1181 in	OD	130.00 mm
3.6260 in	IW	92.10 mm

Group No. IB 0289 - 1

SLB	UEL 215 - 48
NSK	EW 215 - 48 S
NTN	UEL 215 - 300 D 1 W 3



Figure MU 32 
Heavy Duty Spherical Outside Surface Ball Bearings
 Set Screws Type

Figure MU 33 
Medium Duty Spherical Outside Surface Ball Bearings
 Set Screws Type

2.9528 in	ID	75.00 mm
5.5118 in	OD	140.00 mm
3.2520 in	IW	82.60 mm

Group No. IB 0286 - 1

SLB	UC X15
ASAHI	UC X15

Figure MU 33 
Medium Duty Spherical Outside Surface Ball Bearings
 Set Screws Type

3.0000 in	ID	76.20 mm
5.5118 in	OD	140.00 mm
3.2520 in	IW	82.60 mm

Group No. IB 0290 - 1		
SLB	UC X15 - 48	
ASAHI	UC X15 - 48	
BROWNING	VS - 348	
FYH	UC X15 - 48	
INA	GY 1300 KRRB	
NSK	UC X15 - 48 S	
NTN	UC X15 - 300 D 1	
SEALMASTER	2000 - 3 - 3	
SKF	YAR 216 - 300	

Figure MU 32 		
<i>Heavy Duty Spherical Outside Surface Ball Bearings</i>		
<i>Set Screws Type</i>		
3.0000 in	ID	76.20 mm
6.2992 in	OD	160.00 mm
3.2283 in	IW	82.00 mm

Group No. IB 0291 - 1		
SLB	UC 315 - 48	
ASAHI	UC 315 - 48	
FYH	UC 315 - 48	
NSK	UC 315 - 48 S	
NTN	UC 315 - 300 D 1	

Figure MU 31 		
<i>Standard Duty Spherical Outside Surface Ball Bearings</i>		
<i>Set Screws Type</i>		
3.0625 in	ID	77.79 mm
5.5118 in	OD	140.00 mm
3.2520 in	IW	82.60 mm

Group No. IB 0292 - 1		
SLB	UC 216 - 49	
NTN	UC 216 - 301 D 1	

Figure MU 33 		
<i>Medium Duty Spherical Outside Surface Ball Bearings</i>		
<i>Set Screws Type</i>		
3.0625 in	ID	77.79 mm
5.9055 in	OD	150.00 mm
3.3740 in	IW	85.70 mm

Group No. IB 0293 - 1		
SLB	UC X16 - 49	
NTN	UC X16 - 301 D 1	

Figure MU 32 		
<i>Heavy Duty Spherical Outside Surface Ball Bearings</i>		
<i>Set Screws Type</i>		
3.0625 in	ID	77.79 mm
6.6929 in	OD	170.00 mm
3.3858 in	IW	86.00 mm

Group No. IB 0294 - 1		
SLB	UC 316 - 49	
NTN	UC 316 - 301 D 1	

Figure MU 31 		
<i>Standard Duty Spherical Outside Surface Ball Bearings</i>		
<i>Set Screws Type</i>		
3.1250 in	ID	79.38 mm
5.5118 in	OD	140.00 mm
3.2520 in	IW	82.60 mm

Group No. IB 0295 - 1		
SLB	UC 216 - 50	
ASAHI	UC 216 - 50	
NACHI	UC 216 - 50	
NSK	UC 216 - 50 S	
NTN	UC 216 - 302 D 1	

Figure MU 33 		
<i>Medium Duty Spherical Outside Surface Ball Bearings</i>		
<i>Set Screws Type</i>		
3.1250 in	ID	79.38 mm
5.9055 in	OD	150.00 mm
3.3740 in	IW	85.70 mm

Group No. IB 0296 - 1		
SLB	UC X16 - 50	
NSK	UC X16 - 50 S	
NTN	UC X16 - 302 D 1	

Figure MU 32 		
<i>Heavy Duty Spherical Outside Surface Ball Bearings</i>		
<i>Set Screws Type</i>		
3.1250 in	ID	79.38 mm
6.6929 in	OD	170.00 mm
3.3858 in	IW	86.00 mm

Group No. IB 0297 - 1		
SLB	UC 316 - 50	
ASAHI	UC 316 - 50	
NSK	UC 316 - 50 S	
NTN	UC 316 - 302 D 1	

Figure MU 31 		
<i>Standard Duty Spherical Outside Surface Ball Bearings</i>		
<i>Set Screws Type</i>		
3.1496 in	ID	80.00 mm
5.5118 in	OD	140.00 mm
3.2520 in	IW	82.60 mm

Group No. IB 0298 - 1		
SLB	UC 216	
ASAHI	UC 216	

FYH	UC 216	
INA	GYE 80 KRRB	
KOYO	UC 216	
NACHI	UC 216	
NSK	UC 216	
NTN	UC 216 D 1	
RHP	1080 - 80 G	
SEALMASTER	5216	
SKF	YAR 216	
SNR	1080 - 80 G	

Figure MU 33 		
<i>Medium Duty Spherical Outside Surface Ball Bearings</i>		
<i>Set Screws Type</i>		
3.1496 in	ID	80.00 mm
5.9055 in	OD	150.00 mm
3.3740 in	IW	85.70 mm

Group No. IB 0299 - 1		
SLB	UC X16	
ASAHI	UC X16	
FYH	UC X16	
NSK	UC X16	
NTN	UC X16 D 1	
SEALMASTER	5316	

Figure MU 32 		
<i>Heavy Duty Spherical Outside Surface Ball Bearings</i>		
<i>Set Screws Type</i>		
3.1496 in	ID	80.00 mm
6.6929 in	OD	170.00 mm
3.3858 in	IW	86.00 mm

Group No. IB 0300 - 1		
SLB	UC 316	
ASAHI	UC 316	
FYH	UC 316	
NSK	UC 316	
NTN	UC 316 D 1	

Figure MU 31 		
<i>Standard Duty Spherical Outside Surface Ball Bearings</i>		
<i>Set Screws Type</i>		
3.1875 in	ID	80.96 mm
5.5118 in	OD	140.00 mm
3.2520 in	IW	82.60 mm

Group No. IB 0301 - 1		
SLB	UC 216 - 51	
NTN	UC 216 - 303 D 1	
RHP	1080 - 3 3/16 G	
SEALMASTER	2 - 33	
SNR	1080 - 3 3/16 G	

Figure MU 31 
Standard Duty Spherical Outside Surface Ball Bearings
Set Screws Type

3.2500 in	ID	82.55 mm
5.9055 in	OD	150.00 mm
3.3740 in	IW	85.70 mm

Group No. IB 0302 - 1

SLB	UC 217 - 52
ASAHI	UC 217 - 52
FYH	UC 217 - 52
NACHI	UC 217 - 52
NSK	UC 217 - 52 S
NTN	UC 217 - 304 D 1
RHP	1080 - 3 1/4 G
SEALMASTER	2 - 34
SNR	1080 - 3 1/4 G

Figure MU 31 
Standard Duty Spherical Outside Surface Ball Bearings
Set Screws Type

3.3125 in	ID	84.14 mm
5.9055 in	OD	150.00 mm
3.3740 in	IW	85.70 mm

Group No. IB 0303 - 1

SLB	UC 217 - 53
NTN	UC 217 - 305 D 1

Figure MU 31 
Standard Duty Spherical Outside Surface Ball Bearings
Set Screws Type

3.3465 in	ID	85.00 mm
5.9055 in	OD	150.00 mm
3.3740 in	IW	85.70 mm

Group No. IB 0304 - 1

SLB	UC 217
ASAHI	UC 217
FYH	UC 217
KOYO	UC 217
NACHI	UC 217
NSK	UC 217
NTN	UC 217 D 1
RHP	1085 - 85 G
SKF	YAR 217
SNR	1085 - 85 G

Figure MU 31 
Standard Duty Spherical Outside Surface Ball Bearings
Set Screws Type

3.4375 in	ID	87.31 mm
5.9055 in	OD	150.00 mm
3.3740 in	IW	85.70 mm

Group No. IB 0305 - 1

SLB	UC 217 - 55
NSK	UC 217 - 55 S
NTN	UC 217 - 307 D 1
RHP	1085 - 3 7/16 G
SEALMASTER	2 - 37
SNR	1085 - 3 7/16 G

Figure MU 31 
Standard Duty Spherical Outside Surface Ball Bearings
Set Screws Type

3.5000 in	ID	88.90 mm
6.2992 in	OD	160.00 mm
3.7795 in	IW	96.00 mm

Group No. IB 0306 - 1

SLB	UC 218 - 56
ASAHI	UC 218 - 56
FYH	UC 218 - 56
NACHI	UC 218 - 56
NSK	UC 218 - 56 S
NTN	UC 218 - 308 D 1
RHP	1090 - 3 1/2 G
SEALMASTER	2 - 38
SKF	YAR 218 - 308
SNR	1090 - 3 1/2 G

Figure MU 31 
Standard Duty Spherical Outside Surface Ball Bearings
Set Screws Type

3.5433 in	ID	90.00 mm
6.2992 in	OD	160.00 mm
3.7795 in	IW	96.00 mm

Group No. IB 0307 - 1

SLB	UC 218
ASAHI	UC 218
FYH	UC 218
INA	GYE 90 KRRB
KOYO	UC 218
NACHI	UC 218
NSK	UC 218
NTN	UC 218 D 1
RHP	1090 - 90 G
SEALMASTER	5218
SKF	YAR 218
SNR	1090 - 90 G

2021

NIKO & **HYC**[®]

BEARING UNITS INTERCHANGEABLE GUIDE

<http://www.nipponkodobearings.com>

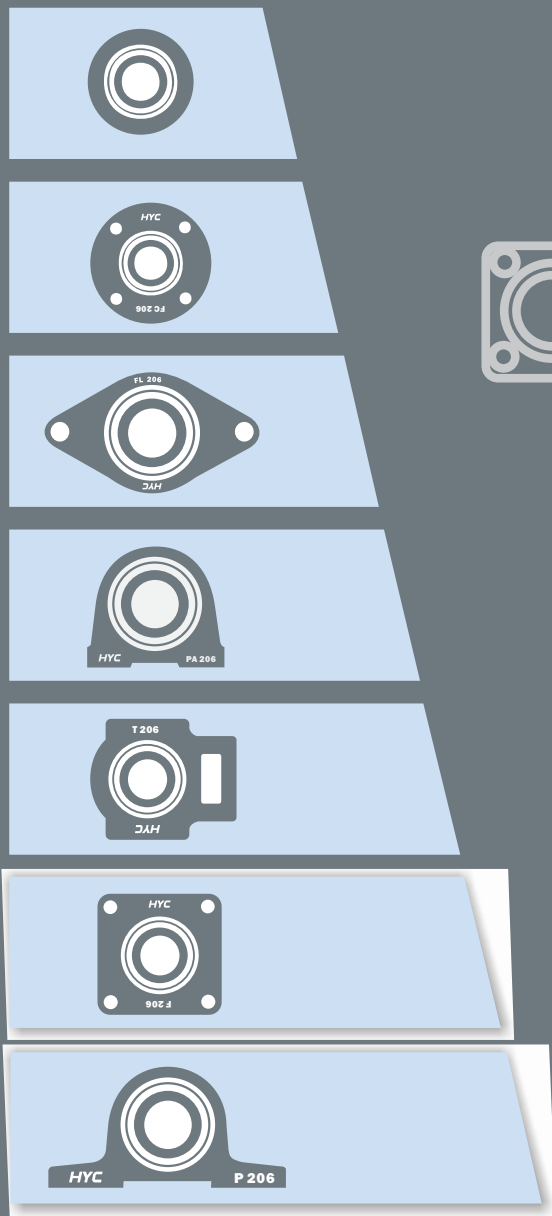
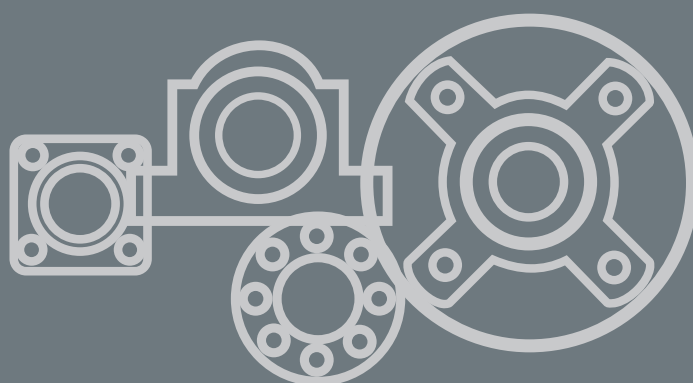

Quality Management



日本高導オートメーションテクノロジー株式会社
会社法人等番号 1309-01-001332